

chcoze

GM-1000

User Manual



Embedded GPU Computing System

9/8th Gen Intel® Xeon®/Core™ Embedded GPU Computer,
 Supports 1x MXM 3.1 GPU Expansion Socket.

Contents

Preface

Revision.....	05
Copyright Notice.....	05
Acknowledgement.....	05
Disclaimer.....	05
Declaration of Conformity.....	05
Product Warranty Statement	06
Technical Support and Assistance.....	07
Conventions Used in this Manual	08
Safety Precaution	08
Package Contents	10
Ordering Information	10

Chapter 1 Product Introductions

1.1 Overview	12
1.2 Highlights	12
1.3 Product Pictures.....	13
1.4 Key Features	13
1.5 Hardware Specification	14
1.6 System I/O	17
1.6.1 Front	17
1.6.2 Rear	18
1.7 Mechanical Dimension	19

Chapter 2 Switches and Connectors

2.1 Location of Switches and Connectors	21
2.1.1 Top View	21
2.1.2 Bottom View	22
2.2 Switches and Connectors Definition.....	23
2.3 Definition of Switches.....	24
2.4 Definition of Connectors	26

Chapter 3 System Setup

3.1 Removing the Top Cover	33
3.2 Install CPU	35
3.3 Install SO-DIMM.....	37
3.4 Install a Mini-PCIe/mSATA Card.....	38

3.5	Install a M.2 E Key Card.....	39
3.6	Install a M.2 M Key Card	40
3.7	Install Antennas	42
3.8	Install the Thermal Pad of Thermal Block.....	44
3.9	Install the Top Cover	44
3.10	Remove the Front Cover Plate.....	46
3.11	Install a SATA Hard Drive at Front Panel	46
3.12	Install a SIM Card	48
3.13	Fasten the Front Cover Plate.....	48
3.14	Wall Mount	49
3.15	VESA Mount.....	50
3.16	Connecting to Power Supply.....	51

Chapter 4 BIOS Setup

4.1	BIOS Introduction	53
4.2	Main Setup	54
4.2.1	System Date	54
4.2.2	System Time	54
4.3	Advanced Setup	55
4.3.1	CPU Configuration	55
4.3.2	Power & Performance.....	56
4.3.3	SATA Configuration.....	56
4.3.4	PCH-FW Configuration.....	57
4.3.5	Trusted Computing	58
4.3.6	ACPI Settings.....	59
4.3.7	F81866 Super IO Configuration.....	60
4.3.8	Hardware Monitor.....	61
4.3.9	S5 RTC Wake Settings.....	62
4.3.10	Serial Port Console Redirection.....	62
4.3.11	USB Configuration.....	63
4.3.12	Network Stack Configuration	63
4.4	Chipset Setup	66
4.4.1	System Agent (SA) Configuration	66
4.4.2	PCH-IO Configuration	68
4.5	Security Setup	71
4.5.1	Administrator Password	71
4.5.2	User Password	71
4.5.3	Security Boot.....	71
4.6	Boot Setup	72

4.6.1 Setup Prompt Timeout.....	72
4.6.2 Bootup NumLock State.....	72
4.6.3 Quiet Boot	72
4.6.4 Fast Boot	72
4.7 Save & Exit	73
4.7.1 Save Changes and Exit	73
4.7.2 Discard Changes and Exit	73
4.7.3 Save Changes and Reset	73
4.7.4 Discard Changes and Reset	73
4.7.5 Save Changes	73
4.7.6 Discard Changes	73
4.7.7 Restore Defaults	73
4.7.8 Save as User Defaults	73
4.7.9 Restore User Defaults	73

Chapter 5 Product Application

5.1 Digital I/O (DIO) application	75
5.1.1 Digital I/O Programming Guide	75
5.2 GM-1000 Digital I/O (DIO) Hardware Specification	82
5.2.1 GM-1000 DIO Connector Definition	83

Chapter 6 Optional Modules and Accessories

6.1 CMI-M12 Module Pin Definition & Settings	86
6.2 CMI-COM Module Pin Definition & Settings.....	87
6.3 CFM-IGN Module Pin Definition & Settings.....	88
6.4 Install an MXM Module.....	89
6.5 Install a High Speed CMI Module.....	92
6.5.1 CMI-M12LAN01-R12/UB1310 module.....	92
6.5.2 CMI-XM12LAN01/UB1330 module.....	95
6.5.2 CMI-10GLAN01/UB1328 module.....	98
6.6 Install a CFM-PoE Module.....	102
6.7 Install a CMI-DIO Module.....	105
6.8 Install a CMI-COM Module.....	107
6.9 Install an CFM-IGN Module.....	109
6.10 Install an External Fan.....	110
6.11 DIN-Rail Mount Brackets.....	112
6.12 Side Mount Bracket.....	113

Preface

Revision

Revision	Description	Date
1.00	First Release	2020/04/17
1.01	Add E-mark Number & CMI-10GLAN module installation steps	2020/08/31
1.02	Correction Made	2020/11/13
1.03	Add DC_IN1 Warning	2021/04/20
1.04	Correction Made	2021/06/28
1.05	Add CMI-XM12LAN01 installation steps	2021/07/26
1.06	Correction Made	2021/10/29
1.07	Correction Made	2022/05/31
1.08	Correction Made	2023/04/14

Copyright Notice

© 2020 by Cincoze Co., Ltd. All rights are reserved. No parts of this manual may be copied, modified, or reproduced in any form or by any means for commercial use without the prior written permission of Cincoze Co., Ltd. All information and specification provided in this manual are for reference only and remain subject to change without prior notice.

Acknowledgement

Cincoze is a registered trademark of Cincoze Co., Ltd. All registered trademarks and product names mentioned herein are used for identification purposes only and may be trademarks and/or registered trademarks of their respective owners.

Disclaimer

This manual is intended to be used as a practical and informative guide only and is subject to change without notice. It does not represent a commitment on the part of Cincoze. This product might include unintentional technical or typographical errors. Changes are periodically made to the information herein to correct such errors, and these changes are incorporated into new editions of the publication.

Declaration of Conformity



FCC

This equipment has been tested and found to comply with the limits for a Class A digital device, pursuant to Part 15 of the FCC Rules. These limits are designed to provide reasonable protection against harmful interference when

the equipment is operated in a commercial environment. This equipment generates, uses, and can radiate radio frequency energy and, if not installed and used in accordance with the instruction manual, may cause harmful interference to radio communications. Operation of this equipment in a residential area is likely to cause harmful interference in which case the user will be required to correct the interference at his own expense.



CE

The product(s) described in this manual complies with all application European Union (CE) directives if it has a CE marking. For computer systems to remain CE compliant, only CE-compliant parts may be used. Maintaining CE compliance also requires proper cable and cabling techniques.

Product Warranty Statement

Warranty

Cincoze products are warranted by Cincoze Co., Ltd. to be free from defect in materials and workmanship for 2 years from the date of purchase by the original purchaser. During the warranty period, we shall, at our option, either repair or replace any product that proves to be defective under normal operation. Defects, malfunctions, or failures of the warranted product caused by damage resulting from natural disasters (such as by lightning, flood, earthquake, etc.), environmental and atmospheric disturbances, other external forces such as power line disturbances, plugging the board in under power, or incorrect cabling, and damage caused by misuse, abuse, and unauthorized alteration or repair, and the product in question is either software, or an expendable item (such as a fuse, battery, etc.), are not warranted.

RMA

Before sending your product in, you will need to fill in Cincoze RMA Request Form and obtain an RMA number from us. Our staff is available at any time to provide you with the most friendly and immediate service.

■ RMA Instruction

- Customers must fill in Cincoze Return Merchandise Authorization (RMA) Request Form and obtain a RMA number prior to returning a defective product to Cincoze for service.
- Customers must collect all the information about the problems encountered and note anything abnormal and describe the problems on the “Cincoze Service Form” for the RMA number apply process.
- Charges may be incurred for certain repairs. Cincoze will charge for repairs to products whose warranty period has expired. Cincoze will also charge for repairs to products if the damage resulted from acts of God, environmental or

atmospheric disturbances, or other external forces through misuse, abuse, or unauthorized alteration or repair. If charges will be incurred for a repair, Cincoze lists all charges, and will wait for customer's approval before performing the repair.

- Customers agree to ensure the product or assume the risk of loss or damage during transit, to prepay shipping charges, and to use the original shipping container or equivalent.
- Customers can be sent back the faulty products with or without accessories (manuals, cable, etc.) and any components from the system. If the components were suspected as part of the problems, please note clearly which components are included. Otherwise, Cincoze is not responsible for the devices/parts.
- Repaired items will be shipped along with a "Repair Report" detailing the findings and actions taken.

Limitation of Liability

Cincoze' liability arising out of the manufacture, sale, or supplying of the product and its use, whether based on warranty, contract, negligence, product liability, or otherwise, shall not exceed the original selling price of the product. The remedies provided herein are the customer's sole and exclusive remedies. In no event shall Cincoze be liable for direct, indirect, special or consequential damages whether based on contract of any other legal theory.

Technical Support and Assistance

1. Visit the Cincoze website at www.cincoze.com where you can find the latest information about the product.
2. Contact your distributor or our technical support team or sales representative for technical support if you need additional assistance. Please have following information ready before you call:
 - Product name and serial number
 - Description of your peripheral attachments
 - Description of your software (operating system, version, application software, etc.)
 - A complete description of the problem
 - The exact wording of any error messages

Conventions Used in this Manual



WARNING

This indication alerts operators to an operation that, if not strictly observed, may result in severe injury.



CAUTION

This indication alerts operators to an operation that, if not strictly observed, may result in safety hazards to personnel or damage to equipment.



NOTE

This indication provides additional information to complete a task easily.

Safety Precautions

Before installing and using this device, please note the following precautions.

1. Read these safety instructions carefully.
2. Keep this User's Manual for future reference.
3. Disconnect this equipment from any AC outlet before cleaning.
4. For plug-in equipment, the power outlet socket must be located near the equipment and must be easily accessible.
5. Keep this equipment away from humidity.
6. Put this equipment on a reliable surface during installation. Dropping it or letting it fall may cause damage.
7. Make sure the voltage of the power source is correct before connecting the equipment to the power outlet.
8. Use a power cord that has been approved for using with the product and that it matches the voltage and current marked on the product's electrical range label. The voltage and current rating of the cord must be greater than the voltage and current rating marked on the product.
9. Position the power cord so that people cannot step on it. Do not place anything over the power cord.
10. All cautions and warnings on the equipment should be noted.
11. If the equipment is not used for a long time, disconnect it from the power source to avoid

damage by transient overvoltage.

12. Never pour any liquid into an opening. This may cause fire or electrical shock.
13. Never open the equipment. For safety reasons, the equipment should be opened only by qualified service personnel.

If one of the following situations arises, get the equipment checked by service personnel:

- The power cord or plug is damaged.
 - Liquid has penetrated into the equipment.
 - The equipment has been exposed to moisture.
 - The equipment does not work well, or you cannot get it work according to the user's manual.
 - The equipment has been dropped and damaged.
 - The equipment has obvious signs of breakage.
14. CAUTION: Danger of explosion if battery is incorrectly replaced. Replace only with the same or equivalent type recommended by the manufacturer.
 15. Equipment intended only for use in a RESTRICTED ACCESS AREA.

Package Contents



Before installation, please ensure all the items listed in the following table are included in the package.

Item	Description	Q'ty
1	GM-1000 GPU Computer	1
2	Remote Power On/Off Terminal Block Connector	1
3	Fan Terminal Block Connector	2
4	CPU Heat Sink and Thermal Pad	1
5	DVI-I to VGA Adaptor	1
6	Screws Pack	1
7	Wall Mount Kit	1
8	Power Terminal Block Connector	2

Note: Notify your sales representative if any of the above items are missing or damaged.

Ordering Information

Model No.	Product Description
GM-1000	9/8th Gen Intel® Xeon®/Core™ Embedded GPU Computer, Supports 1x MXM 3.1 GPU Expansion Socket



Chapter 1

Product Introductions

1.1 Overview

The GM-1000 is a rugged GPU computing platform supporting embedded MXM GPU expansion. It has all the features required for a compact, reliable, and high-performance computing system for field applications in machine vision, image processing, and artificial intelligence.

Based on the latest Intel® Coffee Lake-R platform, GM-1000 is able to equip with 9th/8th generation workstation grade processor up to 8 cores and dual DDR4-2666 SO-DIMM memory up to 64 GB, that can deliver outstanding computing performance for high-end applications.

The compact GPU system, sized at 260 mm x 200 mm x 85 mm, can accommodate 1 x standard MXM 3.1 Type A/B form factor GPU module slot. It allows GPU-accelerated technology from NVIDIA® or AMD® to speed up intensive workloads by executing massive parallel processing, delivering an optimized performance for demanding embedded vision computing applications.

The unique thermal design is adopted for GM-1000 to maximize the heat dissipation efficiency and allows GM-1000 to thrive in extreme environmental conditions. The thermal solution is made possible with the design of industrial grade components, copper heat pipes, a special aluminum extrusion case, and an optional external fan. This thermal design provides effective heat dissipation and allows high performance GPU applications with reliability.

Moreover, the GM-1000 supports extra functionality and I/O expansions. Thru Cincoze's innovative CMI / CFM (Combined Multiple IO / Control Function Module) technologies, the GM-1000 can be extended with PoE, power ignition sensing, and various I/Os such as LAN, M12, DIO, USB, and COM. The technologies provide a customized expansion to fulfill each user's specific needs and applications.

1.2 Highlights



Superb Performance

The GM-1000 supports the latest 9th-gen Intel® Xeon® E-series / Core processors (up to 8-core). The computing engine supports remarkable features such as Turbo Boost and Hyper-Threading technology and offers a significant improvement in performance.



Embedded GPU Expansion

GM-1000 supports MXM 3.1 socket Type A/B module expansion from NVIDIA® / AMD®. To protect the user's investment, GM-1000 is designed with an outstanding system architecture that allows for future upgradability of the MXM module.



Unique Thermal Design

The GM-1000 features a unique and effective thermal design for maximum heat dissipation efficiency that offers stability to the system during GPU-based operation for the field.

1.3 Product Pictures



Front



Rear

1.4 Key Features

- Supports 9th/8th Gen Intel® Xeon®/Core™ Processor Up to 8 Cores
- Supports 1x MXM 3.1 Type A/B form factor GPU module expansion
- 2x DDR4 SO-DIMM sockets, up to 2666MHz, 64GB
- Supports wide operating temperature (-40°C - 70°C) and vibration/shock tolerance (5G/50G)
- 260 mm x 200 mm x 85 mm compact footprint
- Flexible functionality expansions:
 - M.2 E key (CNVi), full-size Mini-PCIe and M.2 M Key (NVMe SSD)
 - Proprietary CMI interface for various I/O expandability
 - Proprietary CFM interface for PoE+ or Power Ignition Sensing

1.5 Hardware Specification

Model Name	GP-3000
System	
Processor	<ul style="list-style-type: none"> • 9th Generation Intel® Coffee Lake-R CPU: <ul style="list-style-type: none"> - Intel® Xeon® E-2278GE 8 Cores Up to 4.7 GHz, TDP 80W - Intel® Xeon® E-2278GEL 8 Cores Up to 3.9 GHz, TDP 35W - Intel® Core™ i7-9700E 8 Cores Up to 4.4 GHz, TDP 65W - Intel® Core™ i5-9500E 6 Cores Up to 4.2 GHz, TDP 65W - Intel® Core™ i3-9100E 4 Cores Up to 3.7 GHz, TDP 65W - Intel® Core™ i7-9700TE 8 Cores Up to 3.8 GHz, TDP 35W - Intel® Core™ i5-9500TE 6 Cores Up to 3.6 GHz, TDP 35W - Intel® Core™ i3-9100TE 4 Cores Up to 3.2 GHz, TDP 35W • 8th Generation Intel® Coffee Lake CPU: <ul style="list-style-type: none"> - Intel® Xeon® E-2176G 6 Cores up to 4.7 GHz, TDP 80W - Intel® Xeon® E-2124G 4 Cores up to 4.5 GHz, TDP 71W - Intel® Core™ i7-8700 6 Cores up to 4.6 GHz, TDP 65W - Intel® Core™ i5-8500 6 Cores, up to 4.1 GHz, TDP 65W - Intel® Core™ i3-8100 4 Cores 3.6 GHz, TDP 65W - Intel® Core™ i7-8700T 6 Cores up to 4.0 GHz, TDP 35W - Intel® Core™ i5-8500T 6 Cores up to 3.5 GHz, TDP 35W - Intel® Core™ i3-8100T 4 Cores 3.1 GHz, TDP 35W - Intel® Pentium® G5400 2 Cores 3.7 GHz, TDP 58W - Intel® Pentium® G5400T 2 Cores 3.1 GHz, TDP 35W - Intel® Celeron® G4900 2 Cores 3.1 GHz, TDP 54W - Intel® Celeron® G4900T 2 Cores 2.9 GHz, TDP 35W
Chipset	<ul style="list-style-type: none"> • Intel® C246
Memory	<ul style="list-style-type: none"> • 2x DDR4-2666/2400 MHz SO-DIMM Sockets • Support up to 64 GB (Un-buffered and non-ECC type) <ul style="list-style-type: none"> * Xeon/i7/i5: Up to DDR4 2666MHz * i3/Pentium/Celeron: Up to DDR4 2400 MHz
BIOS	<ul style="list-style-type: none"> • AMI BIOS
Graphics	
Graphics Engine	<ul style="list-style-type: none"> • Integrated Intel® UHD Graphics (Xeon/i7/i5/i3: UHD 630; Pentium/Celeron: UHD 610)
Maximum Display Output	<ul style="list-style-type: none"> • Supports Triple Independent Display (DVI-I/DisplayPort/HDMI)
DVI-I	<ul style="list-style-type: none"> • 1x DVI-I Connector (VGA: 1920 x1080 @ 60 Hz; DVI-D: 1920 x1200 @ 60 Hz)
DP	<ul style="list-style-type: none"> • 1x DisplayPort Connector (4096 x 2304 @ 60Hz)
HDMI	<ul style="list-style-type: none"> • 1x HDMI Connector (4096 x 2160 @ 30Hz)
Audio	
Audio Codec	<ul style="list-style-type: none"> • Realtek® ALC888, High Definition Audio
Line-out	<ul style="list-style-type: none"> • 1x Line-out, Phone Jack 3.5mm
Mic-in	<ul style="list-style-type: none"> • 1x Mic-in, Phone Jack 3.5mm
I/O	
LAN	<ul style="list-style-type: none"> • 2x GbE LAN Ports (Supports WoL, Teaming, Jumbo Frame & PXE), RJ45 <ul style="list-style-type: none"> - GbE1: Intel® I219-LM GbE2: Intel® I210
COM	<ul style="list-style-type: none"> • 4x RS-232/422/485 with Auto Flow Control (Support 5V/12V), DB9
USB	<ul style="list-style-type: none"> • 4x 10Gbps USB3.2 Gen2 Ports, Type-A

	<ul style="list-style-type: none"> • 4x 5Gbps USB3.2 Gen1 Ports, Type-A
Storage	
SSD/HDD	<ul style="list-style-type: none"> • 2x SATA III (6Gbps) Front Accessible 2.5" HDD/SSD Trays (up to 15mm in height)
mSATA	<ul style="list-style-type: none"> • 3x mSATA (Shared by Mini-PCIe Socket)
M.2 SSD	<ul style="list-style-type: none"> • 1x PCIe x4 M.2 Key M 2280 socket, support NVMe SSD
RAID	<ul style="list-style-type: none"> • Supports RAID 0/ 1/ 5/ 10
Expansion	
MXM	<ul style="list-style-type: none"> • 1x MXM Carrier Board Interface for MXM GPU Module
Mini PCI Express	<ul style="list-style-type: none"> • 3x Full-size Mini-PCIe Socket
M.2 Key E	<ul style="list-style-type: none"> • 1x PCIe x2 M.2 Key E 2230 socket, support Intel CNVi Module
M.2 Key M	<ul style="list-style-type: none"> • 1x PCIe x4 M.2 Key M 2280 socket, support NVMe SSD
SIM Socket	<ul style="list-style-type: none"> • 2x SIM Socket
Antenna	<ul style="list-style-type: none"> • 2x Antenna Holes
CMI (Combined Multiple I/O) Interface	<ul style="list-style-type: none"> • 1 x High Speed CMI (Combined Multiple I/O) Interface <ul style="list-style-type: none"> - CMI-10GLAN01: 2x 10G Intel® X550 RJ45 LAN - CMI-LAN01: 4x 1G Intel® I210 RJ45 LAN - CMI-M12LAN01: 4x 1G Intel® I210 M12 A-Coded LAN - CMI-XM12LAN01: 4x 1G Intel® I210 M12 X-Coded LAN • 1 x Low Speed CMI (Combined Multiple I/O) Interface <ul style="list-style-type: none"> - CMI-COM01: 2x RS232/422/485, Support 5V/12V - CMI-DIO01: 16x DIO (8in 8 out)
CFM (Control Function Module) Interface	<ul style="list-style-type: none"> • 1x CFM (Control Function Module) IGN Interface <ul style="list-style-type: none"> - CFM-IGN01: Ignition Sensing Function
Other Function	
External FAN Connector	<ul style="list-style-type: none"> • 2x External FAN Connector, 4-pin Terminal Block (Supports Smart Fan by BIOS)
Power Ignition Sensing	<ul style="list-style-type: none"> • Support Power Ignition Sensing Function with Delay Time Management and Selectable 12V/24V (With Optional CFM Module)
Clear CMOS Switch	<ul style="list-style-type: none"> • 1x Clear CMOS Switch
Reset Button	<ul style="list-style-type: none"> • 1x Reset Button
Instant Reboot	<ul style="list-style-type: none"> • Support 0.2sec Instant Reboot Technology
Watchdog Timer	<ul style="list-style-type: none"> • Software Programmable Supports 256 Levels System Reset
Power Requirement	
Power Button	<ul style="list-style-type: none"> • 1x ATX Power On/Off Button
Power Mode Switch	<ul style="list-style-type: none"> • 1x AT/ATX Mode Switch
Power Input	<ul style="list-style-type: none"> • Power Input Voltage: 9-48 VDC, Single Power Source • Connector Type: 2x 3-pin Terminal Block, Each Terminal Block Current Limitation is 15A • Power input voltage from 9V to 23V must use dual power connectors, power input voltage from 24V to 48V can use single power connector
Remote Power On/Off	<ul style="list-style-type: none"> • 1x Remote Power On/Off, 2-pin Terminal Block
Total Power Budget	<ul style="list-style-type: none"> • 360W
Power Adaptor	<ul style="list-style-type: none"> • Optional AC/DC 24V Power Adapter, 220W

Physical					
Dimension (W x D x H)	• 260 x 200 x 85 mm				
Weight Information	• 4.6 KG				
Mechanical Construction	• Extruded Aluminum with Heavy Duty Metal				
Mounting	• Wall mount /VESA mount /DIN Rail /Side Mount				
Physical Design	<ul style="list-style-type: none"> • Unibody Design • Fanless Design • Jumper-less Design • Cableless Design 				
Reliability & Protection					
Reverse Power Input Protection	• Yes				
Over Voltage Protection	<ul style="list-style-type: none"> • Protection Range: 51-58V • Protection Type: shut down operating voltage, re-power on at the present level to recover 				
Over Current Protection	• 30A				
CMOS Battery Backup	• SuperCap Integrated for CMOS Battery Maintenance-free Operation				
MTBF	<ul style="list-style-type: none"> • 331,596 Hours -Database: Telcordia SR-332 Issue 3, Method 1, Case 3 				
Environment					
Operating Temperature		CPU	with GPU (58W)	with FAN module	Operating Temp.
		35W	-	-	-40°C ~ 70°C
		65W	-	V	-40°C ~ 60°C
		80W	-	V	-40°C ~ 55°C
		35W	V	V	-40°C ~ 55°C
		65W	V	V	-40°C ~ 55°C
		80W	V	V	-40°C ~ 50°C
<ul style="list-style-type: none"> * PassMark BurnInTest: 100% CPU, 2D Graphics (without thermal throttling) * Furmark: 1920x1080, 8x MSAA (without thermal throttling) * With extended temperature peripherals; Ambient with air flow * According to IEC60068-2-1, IEC60068-2-2, IEC60068-2-14 					
Storage Temperature	• -40°C to 85°C				
Relative Humidity	• 95%RH @ 70°C (non-Condensing)				
Shock	<ul style="list-style-type: none"> • Operating, 50 Grms, Half-sine 11 ms Duration * w/ SSD, according to IEC60068-2-27 				
Vibration	<ul style="list-style-type: none"> • Operating, 5 Grms, 5-500 Hz, 3 Axes * w/ SSD, according to IEC60068-2-64 				
EMC	<ul style="list-style-type: none"> • CE, UKCA, FCC, ICES-003 Class A • EN 50155 (EN 50121-3-2 Only) 				
EMI	<ul style="list-style-type: none"> • CISPR 32 Conducted & Radiated: Class A • EN/BS EN 50121-3-2 Conducted & Radiated: Class A • EN/BS EN IEC 61000-3-2 Harmonic current emissions: Class A • EN/BS EN61000-3-3 Voltage fluctuations & flicker • FCC 47 CFR Part 15B, ICES-003 Conducted & Radiated: Class A 				
EMS	<ul style="list-style-type: none"> • EN/IEC 61000-4-2 ESD: Contact: 6 kV; Air: 8 kV • EN/IEC 61000-4-3 RS: 80 MHz to 1000 MHz: 20 V/m • EN/IEC 61000-4-4 EFT: AC Power: 2 kV; Signal: 2 kV • EN/IEC 61000-4-5 Surges: AC Power: 2 kV • EN/IEC 61000-4-6 CS: 10V • EN/IEC 61000-4-8 PFMF: 50 Hz, 1A/m 				

	<ul style="list-style-type: none"> • EN/IEC 61000-4-11 Voltage Dips & Voltage Interruptions: 0.5 cycles at 50 Hz
Safety	<ul style="list-style-type: none"> • LVD, EN62368-1
Operating System	
Windows	<ul style="list-style-type: none"> • Windows® 10
Linux	<ul style="list-style-type: none"> • Supports by project

* Product Specifications and features are for reference only and are subject to change without prior notice. For more information, please refer to the latest product datasheet from Cincoze's website.

1.6 System I/O

1.6.1 Front

ATX Power On/Off

Used to power-on or power-off the system

HDD LED

Indicates the status of the hard drive

GPIO LED

Indicates the status of the GPIO

IGN LED

Indicates the status of the IGN function

GPU LED

Indicates the status of the GPU temperature

Ethernet LED

Indicates the status of the Ethernet LAN

USB3.2 Gen2

Used to connect to USB 3.2 Gen2/3.2

Gen1/2.0/1.1 compatible devices

2.5" Hot Swap HDD/SSD Bay

Used to insert a 2.5" SATA HDD/SSD

IGN Setting Switch

Used to set up IGN function

SIM Card Slot

Used to insert a SIM card

Clear CMOS

Used to clear CMOS to reset BIOS

AT/ATX Mode Select Switch

Used to select AT or ATX power mode

Reset Button

Used to reset the system

Universal I/O Bracket

Used to customized I/O output with optional modules

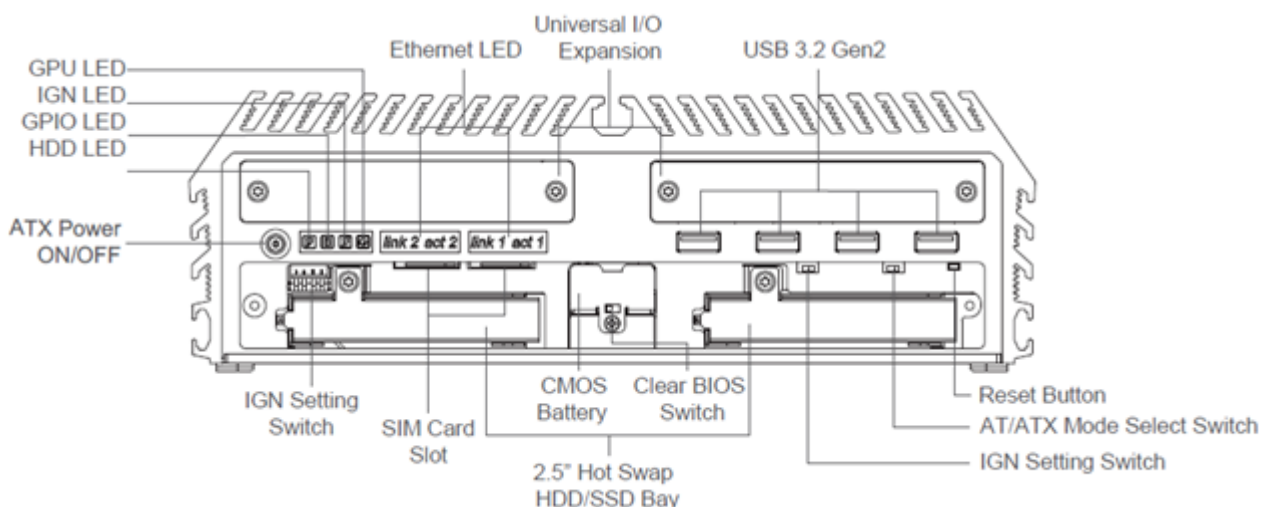

1.6.2 Rear

DC IN

Used to plug a DC power input with terminal block

LAN

Used to connect to local area network

USB3.2 Gen1

Used to connect to USB 3.2 Gen1/2.0/1.1 compatible devices

DVI-I Port

Used to connect a DVI monitor or connect optional split cable for dual display mode

External Fan Power

Used to plug an external fan with terminal block

Display Port

Used to connect a monitor with DisplayPort interface

HDMI Port

Used to connect the system with HDMI monitor

COM Port

Used to connect to RS-232/422/485 serial devices

Digital I/O Terminal Block

The Digital I/O terminal block supports 16 isolated DIO (8 digital input and 8 digital output)

Line-Out

Used to connect a speaker

Mic-In

Used to connect a microphone

Remote Power On/Off

A terminal block used to connect to remote power on/off switch

Antenna Hole

Used to connect an antenna for optional wireless module

Universal I/O Bracket

Used to customized I/O output with optional modules

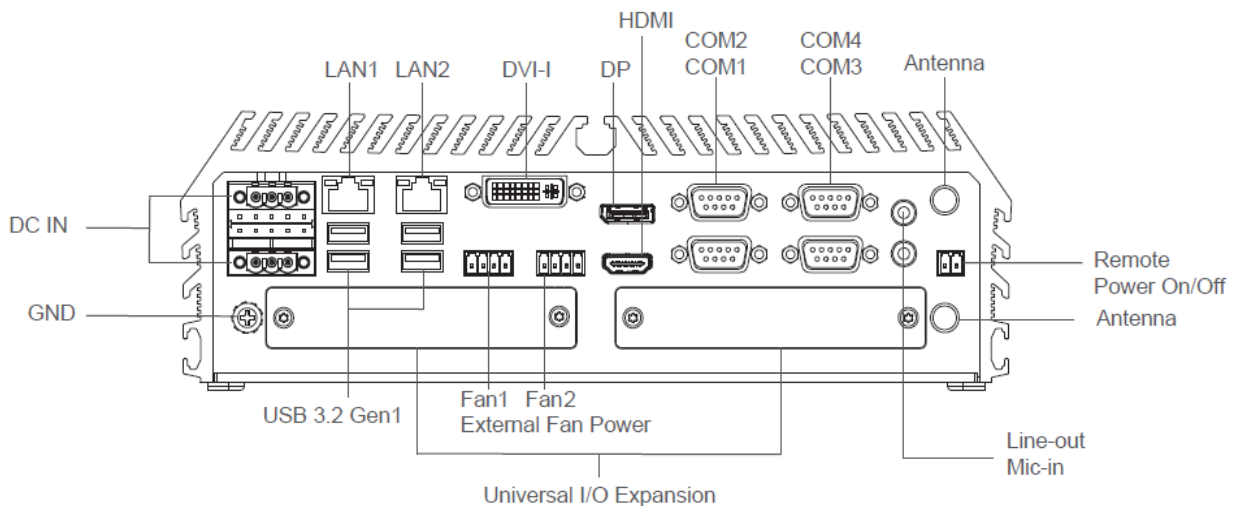

1.7 Mechanical Dimension

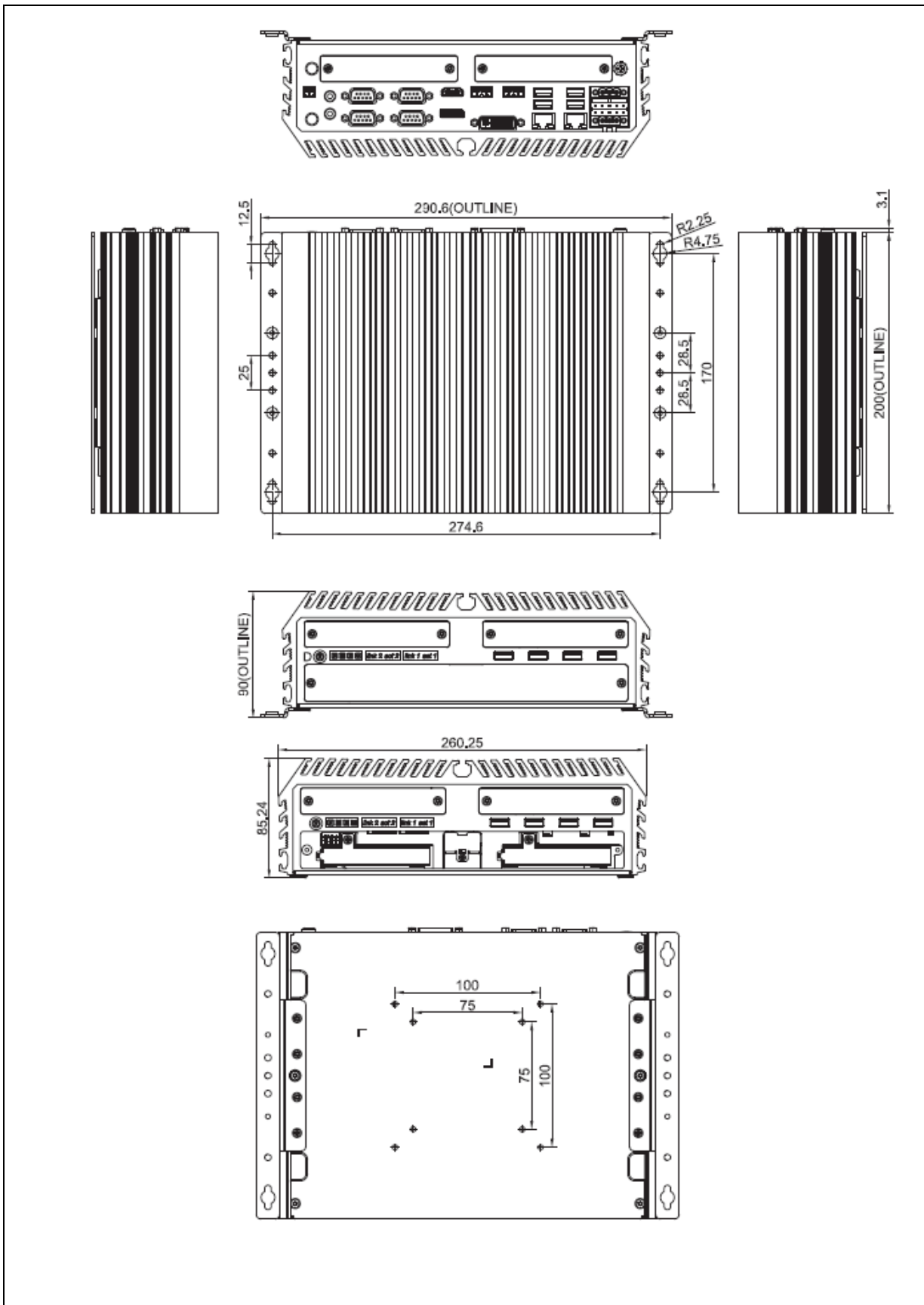



Chapter 2

Switches & Connectors

2.1 Location of Switches and Connectors

2.1.1 Top View

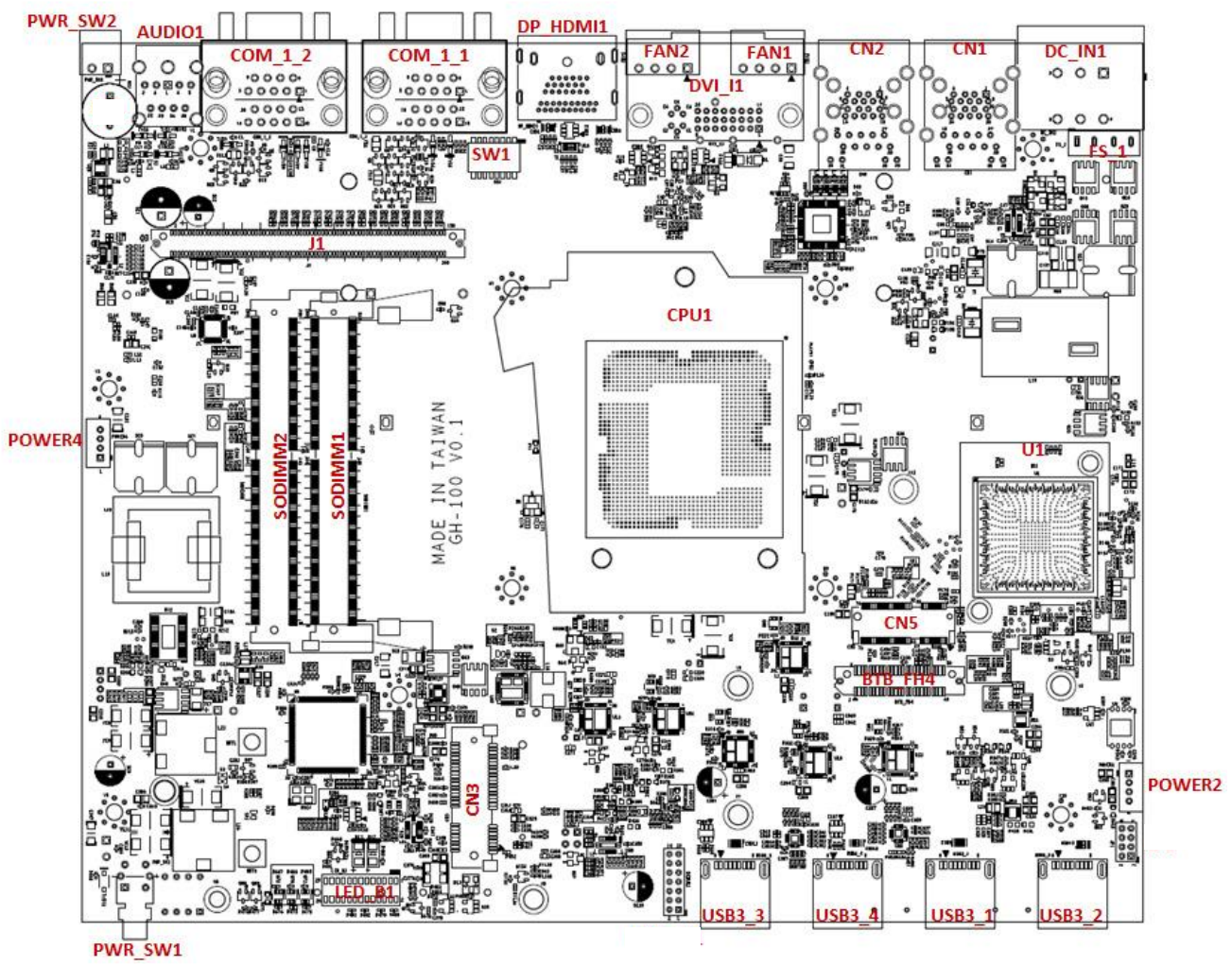

2.1.2 Bottom View

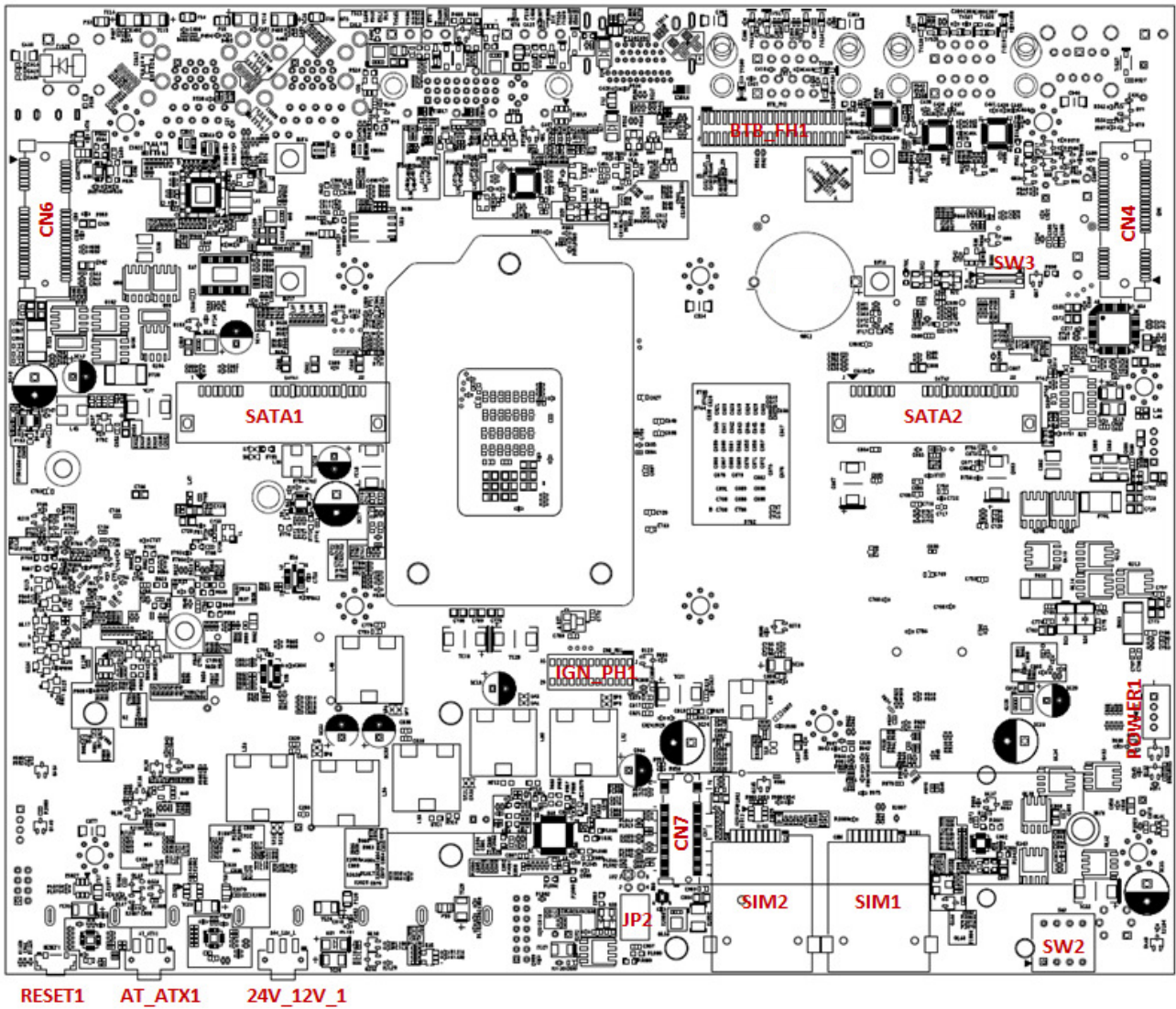

2.2 Switches and Connectors Definition

List of Switch

Location	Definition
AT_ATX	AT/ATX power mode switch (default ATX mode)
CLR_CMOS4	Clear CMOS Switch
PWR_SW1	Power button with Power LED
Reset1	Reset Switch
SW1	COM1/COM2/COM3/COM4 Power Select
SW3	Super CAP Switch

List of Connector

Location	Definition
AUDIO1	2 IN 1 Audio Phone Jack for Headphone line out & MIC phone in
BTB_FH1	CMI BTB 44 pins header (Support DIO and COM5~6 RS232/RS422/RS485)
BTB_FH4	CMI BTB 50 pins header (Support 1GbE 4LAN /10GbE LAN Board)
COM1_1, COM1_2	RS232 / RS422 / RS485 Connector
CN1, CN2	Giga LAN connector + USB3.2 Gen1/USB2.0 Port x4
CN3	Mini PCI-Express Socket (Support mPCIe/ mSATA/ USB / SIM Module)
CN4, CN6	Mini PCI-Express Socket (Support mPCIe & mSATA)
CN5	M.2 Key E Socket (Support discrete Wi-Fi/Intel CNVi module)
CN7	M.2 (NGFF) Card Key M Socket (Support NVMe SSD module)
DC_IN1	3 PINs x2 DC 9-48V power input with power ignition connector
DP_HDMI1	Display Port and HDMI connector
DVI_I1	DVI-I connector
FAN1	CPU smart FAN connector
FAN2	GPU (MXM) smart FAN connector
FS_1	DC input power fuse 30A/58V
IGN_PH1	IGN control board connector
J1	PEG to MXM carrier board 150 pins connector
JP2	RTC battery board connector
LED_B1	LED board connector for HDD/ GPIO/ IGN/ GPU Temperature LED
POWER1, POWER2, POWER4	+5V/+12V power output connector
PWR_SW2	Remote Power On/Off Switch Connector
SATA1, SATA2	22 PINs SATA Connector
SIM1, SIM2	SIM Card Socket A and B
SODIMM1, SODIMM2	DDR4 SO-DIMM
USB3_1, USB3_2, USB3_3, USB3_4	USB3.2 Gen2/USB 2.0 port connector

2.3 Definition of Switches

AT_ATX: AT / ATX Power Mode Switch

Switch	Definition
1-2 (Right)	ATX Power Mode (Default)
2-3 (Left)	AT Power Mode



CLR_CMOS4: Clear CMOS Switch

Switch	Definition
1-2 (Left)	Normal (Default)
2-3 (Right)	Clear CMOS



PWR_SW1: Power button with Power LED

Switch	Definition
Push	Power System



LED Type	LED Status	Status
Power LED	Blue	Power off (S4/S5)
	Green	Power on (S0)
	Blinking Blue & Green	Stand by (S3)

RESET1: Reset Switch

Switch	Definition
Push	Reset System



SW1: COM1/COM2/COM3/COM4 Power Select

Location	Function		DIP1	DIP2
SW1	COM1	0V(RI)	ON (Default)	ON (Default)
		5V	ON	OFF
		12V	OFF	OFF

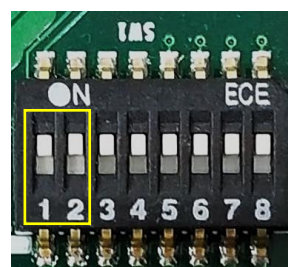

ON
OFF

Location	Function		DIP3	DIP4
SW1	COM2	0V(RI)	ON (Default)	ON (Default)
		5V	ON	OFF
		12V	OFF	OFF

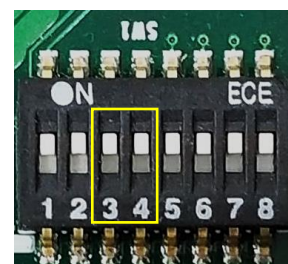

ON
OFF

Location	Function		DIP5	DIP6
SW1	COM3	0V(RI)	ON (Default)	ON (Default)
		5V	ON	OFF
		12V	OFF	OFF

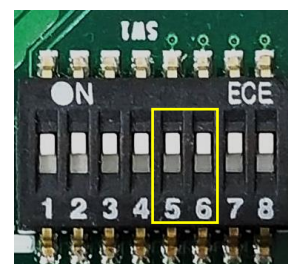

ON
OFF

Location	Function		DIP7	DIP8
SW1	COM4	0V(RI)	ON (Default)	ON (Default)
		5V	ON	OFF
		12V	OFF	OFF

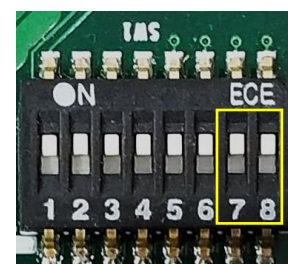

ON
OFF

SW3: Super CAP Switch

Location	Function		DIP1	DIP2
SW3	Super CAP Enabled		ON (Default)	ON (Default)
	Super CAP Disabled		OFF	OFF



ON
OFF

2.4 Definition of Connectors

CN3 : Mini PCI-Express Socket (Support mPCIE/ mSATA/ USB3.0 / SIM Module)

PIN	Definition	PIN	Definition
1	WAKE#	27	GND
2	3.3V	28	+1.5V
3	NA	29	GND
4	GND	30	SMB_CLK
5	NA	31	PETn0
6	1.5V	32	SMB_DATA
7	UIM_RESET_B	33	PETp0
8	UIM_PWR_A	34	GND
9	GND	35	GND
10	UIM_DATA_A	36	USB_D-
11	REFCLK-	37	GND
12	UIM_CLK_A	38	USB_D+
13	REFCLK+ / UIM_PWR_B	39	+3.3Vaux
14	UIM_RESET_A	40	GND
15	GND	41	+3.3Vaux
16	UIM_VPP_A	42	NA
17	UIM_IC_DM / (UIM_CLK_B)	43	GND
18	GND	44	NA
19	UIM_IC_DP / (UIM_DATA_B)	45	CL_CLK
20	W_DISABLE1#	46	NA
21	GND	47	CL_DATA
22	PERST#	48	+1.5V
23	PERn0	49	CL_RST
24	+3.3Vaux	50	GND
25	PERp0	51	NA
26	GND	52	+3.3Vaux

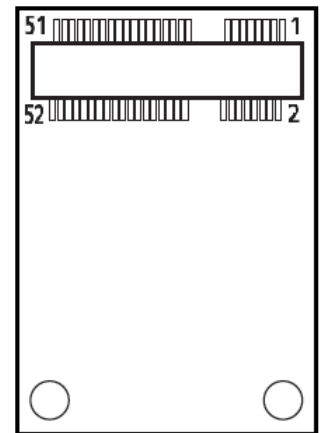

CN4 : Mini PCI-Express Socket (Support mPCIE/ mSATA/ USB3.0)

PIN	Definition	PIN	Definition
1	WAKE#	27	GND
2	3.3Vaux	28	+1.5V
3	NA	29	GND
4	GND	30	SMB_CLK
5	NA	31	PETn0/SATA_TXN
6	1.5V	32	SMB_DATA
7	NA	33	PETp0/SATA_TXP
8	NA	34	GND
9	GND	35	GND
10	NA	36	USB_D-
11	REFCLK-	37	GND
12	NA	38	USB_D+
13	REFCLK+	39	+3.3Vaux
14	NA	40	GND
15	GND	41	+3.3Vaux
16	NA	42	NA
17	NA	43	GND
18	GND	44	NA
19	NA	45	NA
20	W_DISABLE1#	46	NA
21	GND	47	NA
22	PERST#	48	+1.5V
23	PERn0/SATA_RXP	49	NA
24	+3.3Vaux	50	GND
25	PERp0/SATA_RXN	51	NA
26	GND	52	+3.3Vaux

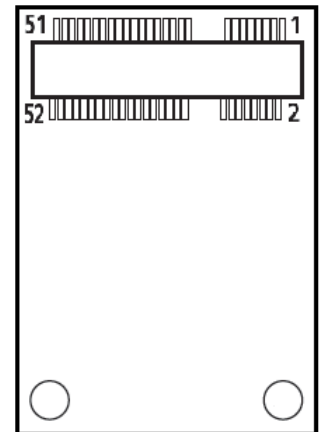

CN6 : Mini PCI-Express Socket (Support mPCIE & mSATA)

PIN	Definition	PIN	Definition
1	WAKE#	27	GND
2	3.3Vaux	28	+1.5V
3	NA	29	GND
4	GND	30	SMB_CLK
5	NA	31	PETn0/SATA_TXN
6	1.5V	32	SMB_DATA
7	NA	33	PETp0/SATA_TXP
8	NA	34	GND
9	GND	35	GND
10	NA	36	USB_D-
11	REFCLK-	37	GND
12	NA	38	USB_D+
13	REFCLK+	39	+3.3Vaux
14	NA	40	GND
15	GND	41	+3.3Vaux
16	NA	42	NA
17	NA	43	GND
18	GND	44	NA
19	NA	45	NA
20	W_DISABLE1#	46	NA
21	GND	47	NA
22	PERST#	48	+1.5V
23	PERn0/SATA_RXP	49	NA
24	+3.3Vaux	50	GND
25	PERp0/SATA_RXN	51	NA
26	GND	52	+3.3Vaux

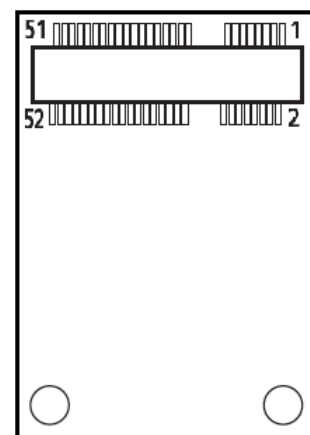

CN5 : M.2 Key E socket (Support discrete Wi-Fi/Intel CNVi module)

Pin	Definition	Pin	Definition	Pin	Definition
1	GND	27	KEY E	53	CLKREQ0#
2	3.3V	28	KEY E	54	W_DISABLE2#
3	USB_D+	29	KEY E	55	PEWAKE0#
4	3.3V	30	KEY E	56	W_DISABLE1#
5	USB_D-	31	KEY E	57	GND
6	LED1#	32	UARTX/RGI_DT	58	I2C_DATA
7	GND	33	GND	59	WT_D1N/PETP1
8	PCM_CLK	34	UART_CTS/RGI_RSP	60	I2C_CLK
9	WGR_D1N	35	PETP0	61	WT_D1P/PETN1
10	PCM_SYNC/LPC_RSTN	36	UART_RTS/BRI_DT	62	ALERT#
11	WGR_D1P	37	PETN0	63	GND
12	PCM_IN	38	CLINK_REST	64	REF_CLK
13	GND	39	GND	65	WT_D0N/PERP1
14	PCM_OUT	40	CLINK_DATA	66	PERST1#
15	WGR_D0N	41	PERP0	67	WT_D0P/PERN1
16	LED2#	42	CLINK_CLK	68	CLKREQ1#
17	WGR_D0P	43	PERN0	69	GND
18	GND	44	COEX3	70	PEWAKE1#
19	GND	45	GND	71	WT_CLKN/REFCLKP1
20	UART_WAKE#	46	COEX_RXD	72	3.3V
21	WGR_CLKN	47	REFCLKP0	73	WT_CLKP/REFCLKN1
22	UART_RX/BRI_RSP	48	COEX_TXD	74	3.3V
23	WGR_CLKP	49	REFCLKN0	75	GND
24	KEY E	50	SUSCLK		
25	KEY E	51	GND		
26	KEY E	52	PERST0#		

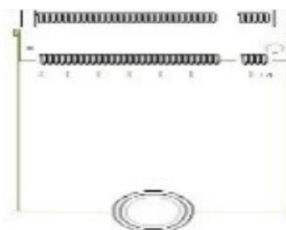

CN7 : M.2 (NGFF) Card Key M Socket (Support NVMe SSD module)

Pin	Definition	Pin	Definition	Pin	Definition
1	CFG3	27	GND	53	REFCLKN
2	3.3V	28	NC	54	PEWAKE*/NC
3	GND	29	PERN1	55	REFCLKP
4	3.3V	30	NC	56	NC
5	PERN3-	31	PERP1	57	GND
6	NC	32	NC	58	NC
7	PERP3	33	GND	59	KEY M
8	NC	34	NC	60	KEY M
9	GND	35	PETN1	61	KEY M
10	DAS/DSS*	36	NC	62	KEY M
11	PETN3	37	PETP1	63	KEY M
12	3.3V	38	DEVSLP	64	KEY M
13	PETP3	39	GND	65	KEY M
14	3.3V	40	SMB_CLK	66	KEY M
15	GND	41	PERN0/SATA_B+	67	NC
16	3.3V	42	SMB_DATA	68	SUSCLK
17	PERN2	43	PERP0/SATA_B-	69	PEDET/CFG1
18	3.3V	44	ALERT#	70	3.3V
19	PERP2	45	GND	71	GND
20	NC	46	NC	72	3.3V
21	CFG0	47	PETN0/SATA_A-	73	GND
22	NC	48	NC	74	3.3V
23	PETN2	49	PETP0/SATA_A+	75	CFG2
24	NC	50	PERST*/NC		
25	PETP2	51	GND		
26	NC	52	CLKREQ*/NC		

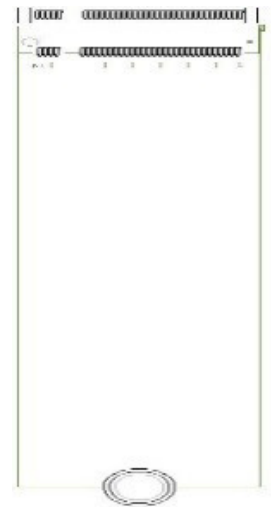

COM1 / COM2 / COM3 / COM4: RS232 / RS422 / RS485 Connector

Connector Type: 9-pin D-Sub

Pin	RS232 Definition	RS422 / 485 Full Duplex Definition	RS485 Half Duplex Definition
1	DCD	TX-	DATA -
2	RXD	TX+	DATA +
3	TXD	RX+	
4	DTR	RX-	
5	GND		
6	DSR		
7	RTS		
8	CTS		
9	RI		



DC_IN1: 3 PINs x2 DC 9-48V power input with power ignition connector

Connector Type: 2x 3-pins Terminal Block , 5.0mm pitch

Pin	Definition
1	9_48VSB_IN
2	9_32VSB_ACC (IGN)
3	GND
4	9_48VSB_IN
5	NC
6	GND

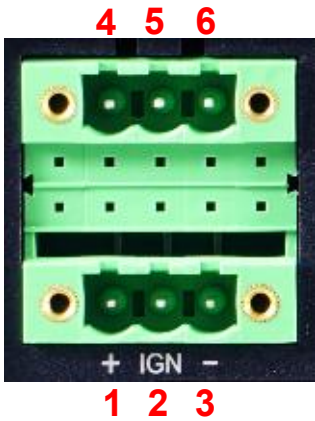

WARNING

Only Single Power Source can connect to DC_IN1. Please disconnect the power source before mounting the DC power cables or connecting the DC power connector to system.

FAN1 : CPU smart FAN connector

FAN2 : GPU (MXM) smart FAN connector

Connector Type: 1x 4-pins Terminal Block , 3.5mm pitch

Pin	Definition
1	GND
2	+12V
3	FAN_IN
4	FAN_PWM

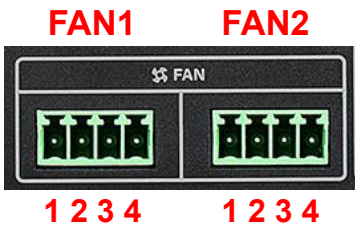

LED_B1: LED board connector for HDD/ GPIO/ IGN/ GPU/ LAN LED

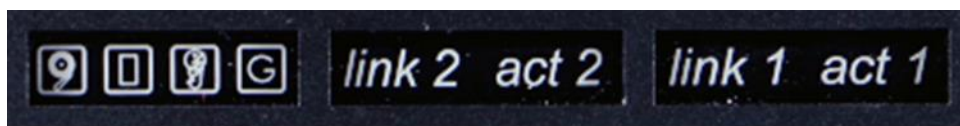

HDD LED GPIO LED IGN LED GPU LED LAN2 Link LED LAN2 Act LED LAN1 Link LED LAN1 Act LED

LED Type	LED Status	Definition
HDD LED	Blinking Yellow	Data activity
	Off	No activity
GPIO LED	Green	GPIO detected
	Off	Not detected
IGN LED	IGN Disabled	Off
	IGN Enabled	Blue
	ACC ON	Green
GPU LED	Green	GPU detected
	Off	Not detected
LAN Link LED	Green	1Gbps Network Link
	Orange	100Mbps Network Link
	Off	10Mbps Network Link
LAN Act LED	Blinking Yellow	Data activity
	Off	No activity

POWER1 / POWER2 / POWER4: +5V/+12V power output connector

Connector Type: 1x4 4-pin Wafer, 2.0mm pitch

Pin	Definition
1	+5V
2	GND
3	GND
4	+12V

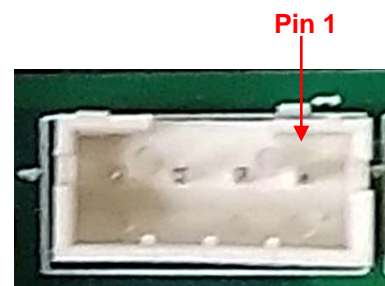

PWR_SW2: Remote Power On/Off Switch Connector



Connector Type: Terminal Block 1X2 2-pin, 3.5mm pitch

Pin	Definition
1	PWR_SW
2	GND



WARNING

Do not apply power to this connector!
This port is used to connect a SWITCH!



Chapter 3

System Setup

3.1 Remove the Top Cover



WARNING

In order to prevent electric shock or system damage, before removing the chassis cover, must turn off power and disconnect the unit from power source.

1. Turn over the unit to have the bottom side face up, loosen the 6 screws on the bottom cover and place them aside for later use.



2. Remove the bottom cover from the chassis.



3. Loosen the 4 screws. Pull out 4 latches as marked on photo.

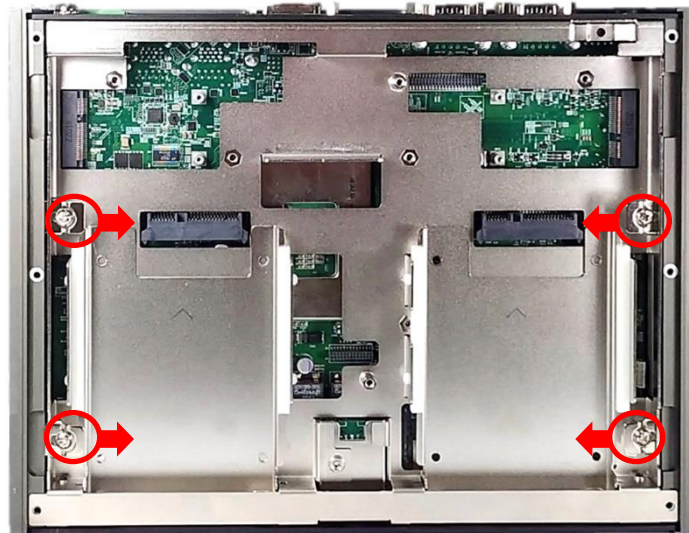

4. Hold front and rear panel and lift up the body of unit vertically.



5. Turn over the body of the unit and place it gently.

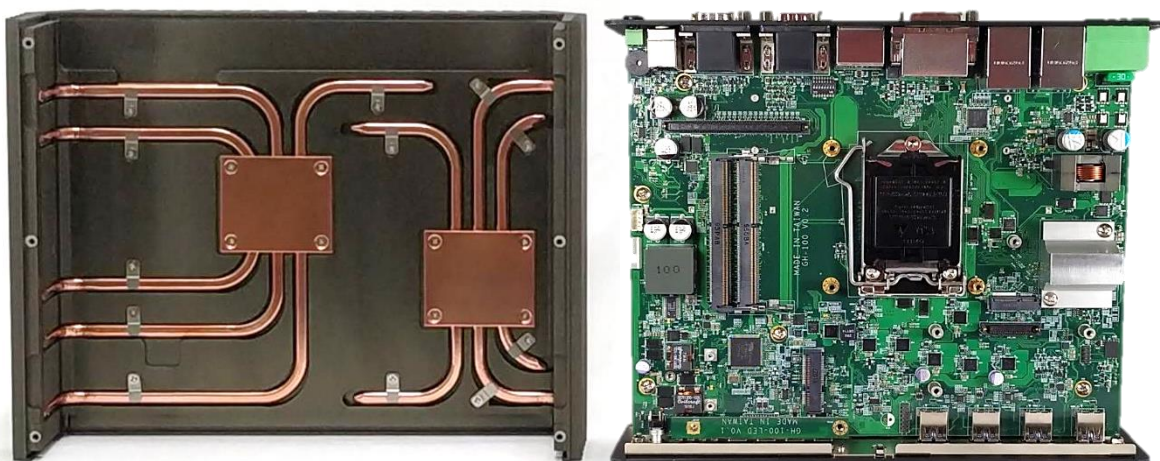

3.2 Install CPU

1. Locate the CPU socket, remove the protection cover on it.

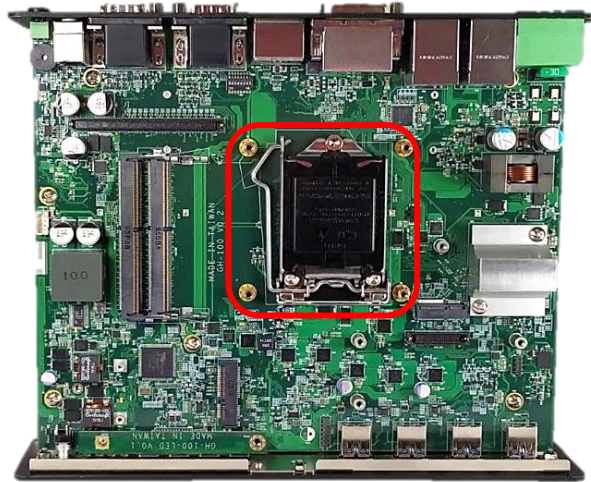

2. Pull aside and then lift up the socket lever to unlock the socket.

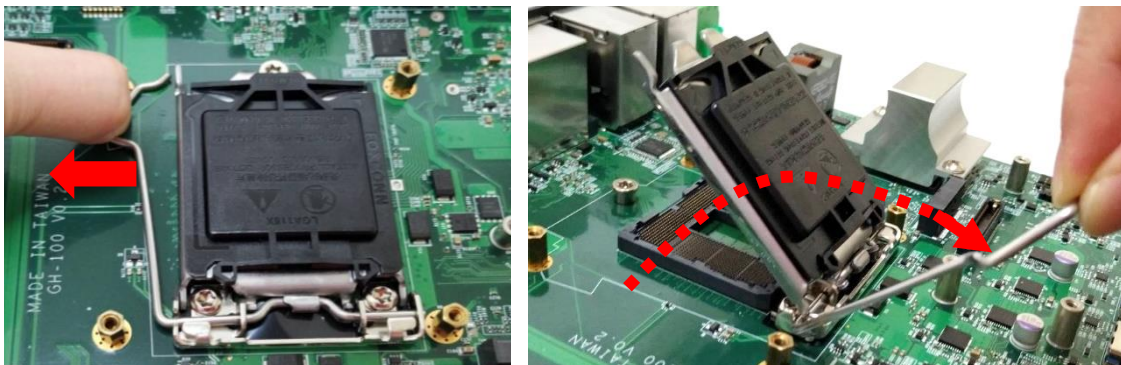

3. Align the notches on CPU with the alignment post on socket. Hold the CPU by the edges toward the notches and insert the CPU gently.

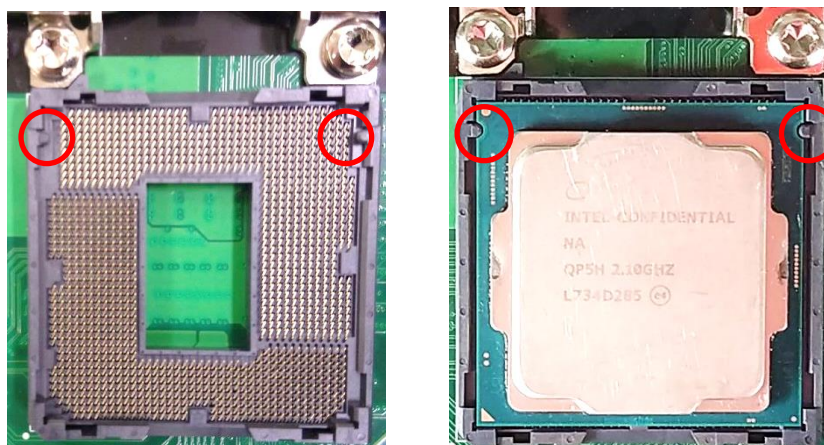

- Place the thermal pad on the CPU heat spreader. Press down the socket lever to lock the CPU.

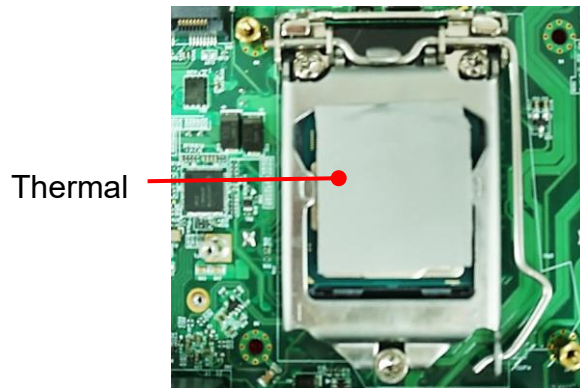

CAUTION

Before putting on the thermal block (in the next step), please make sure the protective film on the Thermal Pad has been removed!

- Align the four mounting holes and put on the CPU heat sink. Please note: the sign “▽ Front” means to face the side of the thermal block to the front panel.

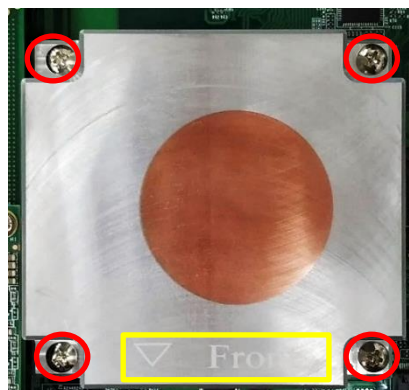

- Place the thermal pad on the CPU heat sink.

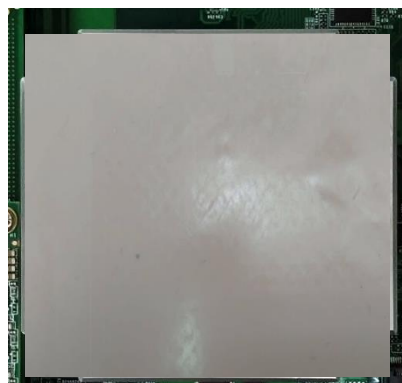

CAUTION

Before assembling the system's chassis cover, please make sure the protective film on the Thermal Pad has been removed!

3.3 Install SO-DIMM

1. Locate the SODIMM socket on the top side of system.

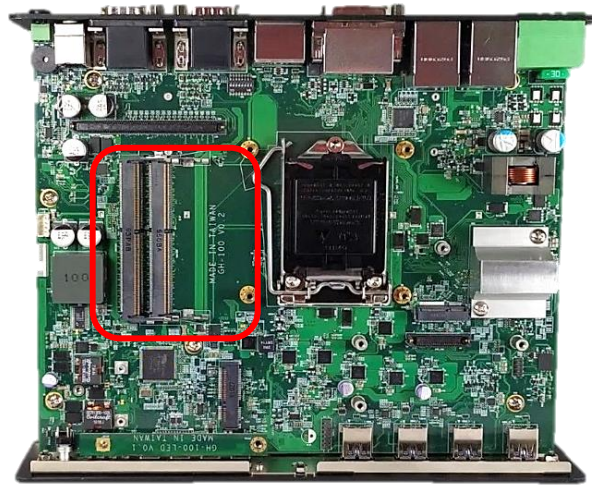

2. Insert a SO-DIMM at a 45-degree angle until its edge connector is connected to SO-DIMM socket firmly.

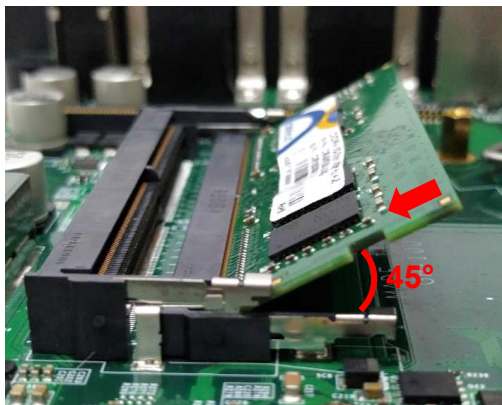

Lower socket

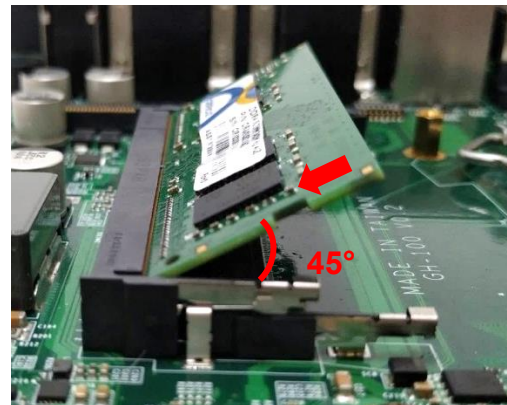

Upper socket

3. Press down the module until the retaining clips snap back in place.



Lower socket



Upper socket

3.4 Install a Mini-PCle/mSATA Card

1. Locate the Mini PCIe socket (CN3/CN4/CN6) on the system board.

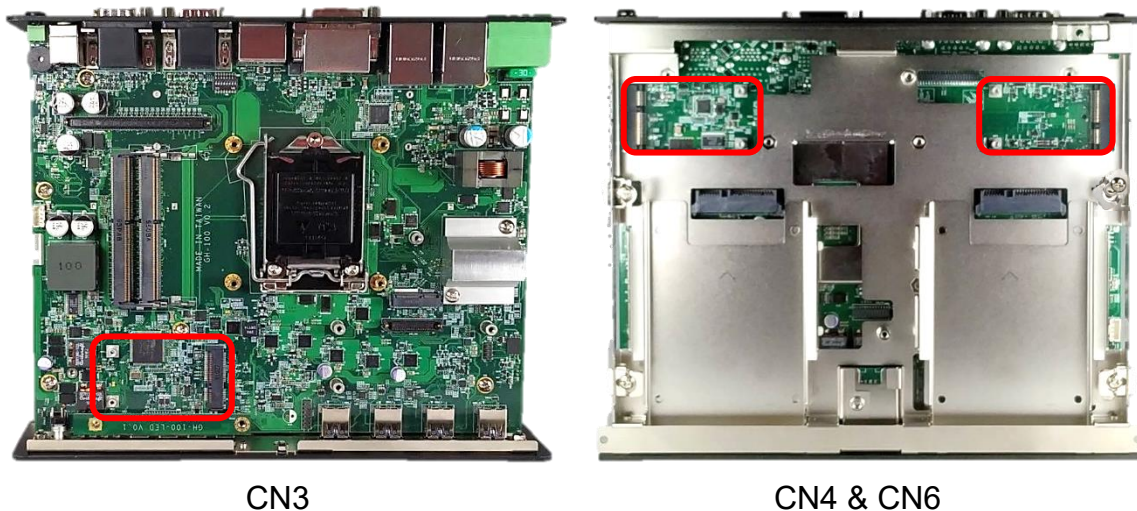

2. Tilt a Mini PCIe card/mSATA Card at a 45-degree angle and insert it to the socket until the golden finger connector of the card seated firmly.



3. Press the card down and secure it with 2 screws.

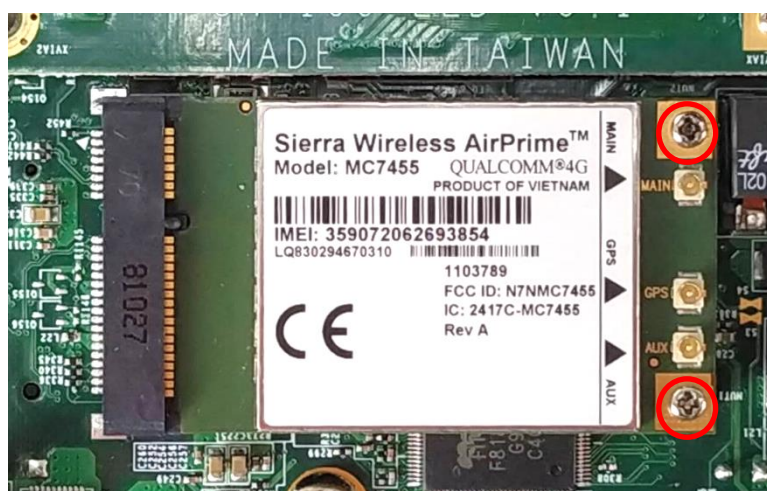

3.5 Install a M.2 E Key Card

1. Locate the M.2 E Key slot (CN5) on the system board.

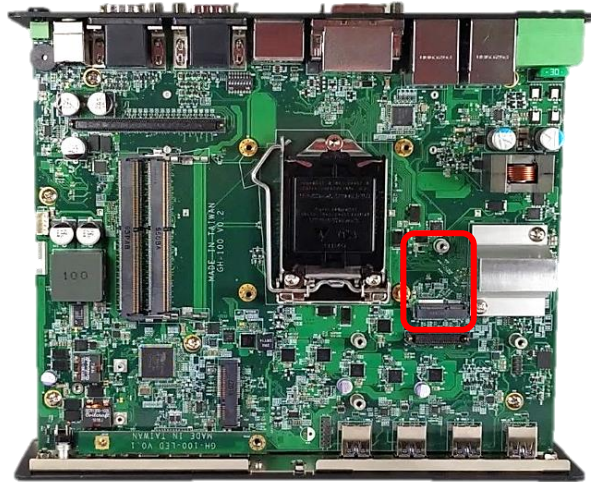

2. Tilt the M.2 E Key card at a 45-degree angle and insert it to the socket until the golden finger connector of the card seated firmly.

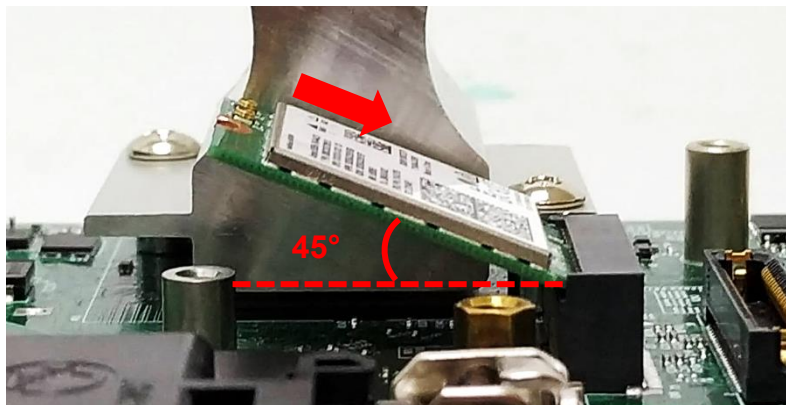

3. Press the card down and secure it with 1 screw.



3.6 Install a M.2 M Key Card

1. Please follow the instruction in chapter 3.10 to remove the front cover plate, and then loosen the screw to remove the HDD bay cover bracket.



2. Pull the rotating arm and HDD bracket out of system.

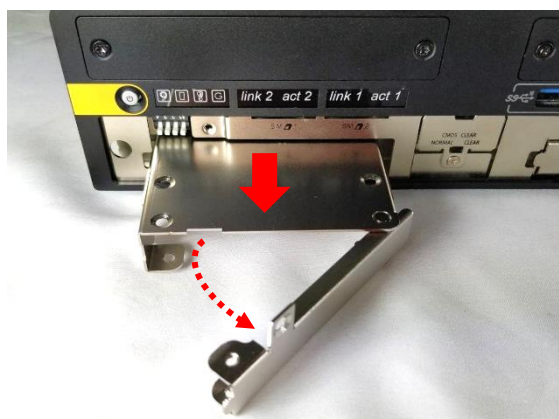

3. Locate the M.2 M Key slot (CN7) on the system board.

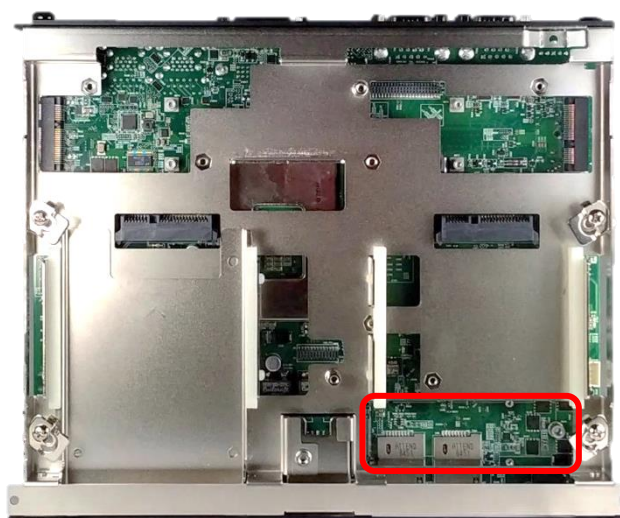

4. Tilt the M.2 M Key card at a 45-degree angle and insert it to the socket until the golden finger connector of the card seated firmly.

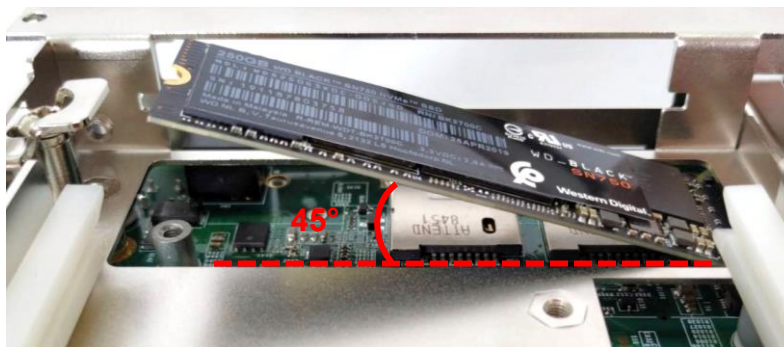

5. Press the card down and secure it with the screw.

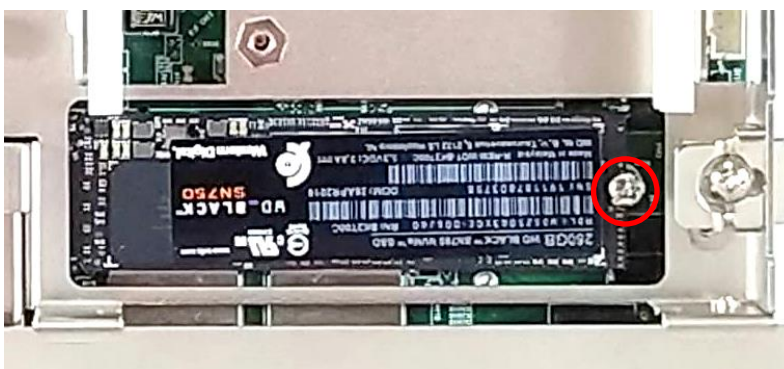

3.7 Install Antennas

1. Remove the antenna rubber cover on the rear panel.



2. For Antenna #1, penetrate the antenna jack through the hole.



For Antenna #2, loosen the screws on rear panel to remove the rear panel first, and place them aside for later use. Penetrate the antenna jack through the hole.

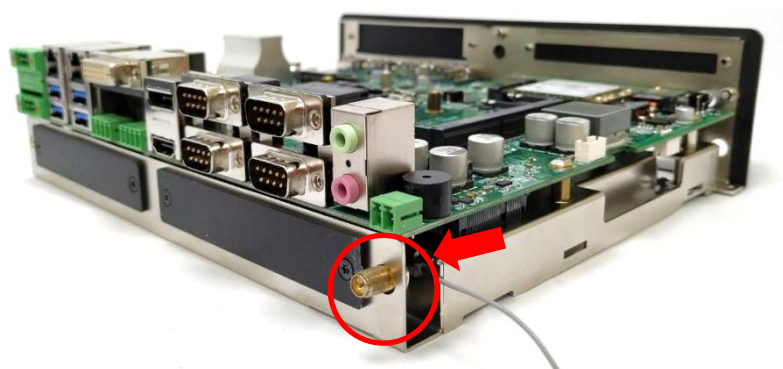
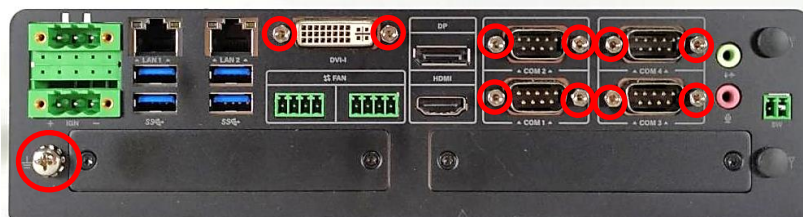

3. For Antenna #1, put on the washer and fasten the nut of antenna jack.



For Antenna #2, put the rear panel back onto the system and fasten the screws removed previously. Put on the washer and fasten the nut of antenna jack.



4. Assemble the antenna and antenna jack together



5. Attach the RF connector at another end of the cable onto the card.



3.8 Install the Thermal Pad of PCH Thermal Block

1. Place thermal pad on the top of PCH thermal block in order to provide a seamless contact with the body of chassis to create an efficient heat dissipation.

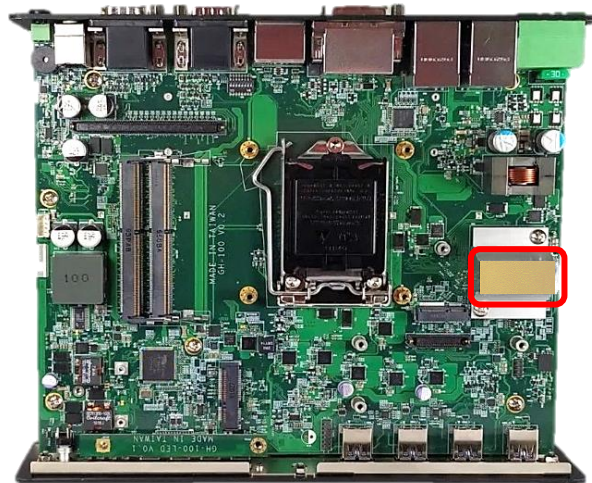

CAUTION

The yellow surface is part of the thermal pad. Do not tear it off as it would affect the thermal conductivity.

3.9 Install the Top Cover

1. Hold front and rear panel and put the body of unit back to the chassis.



2. Push the four latches back into the chassis, and fasten the 4 screws as marked.

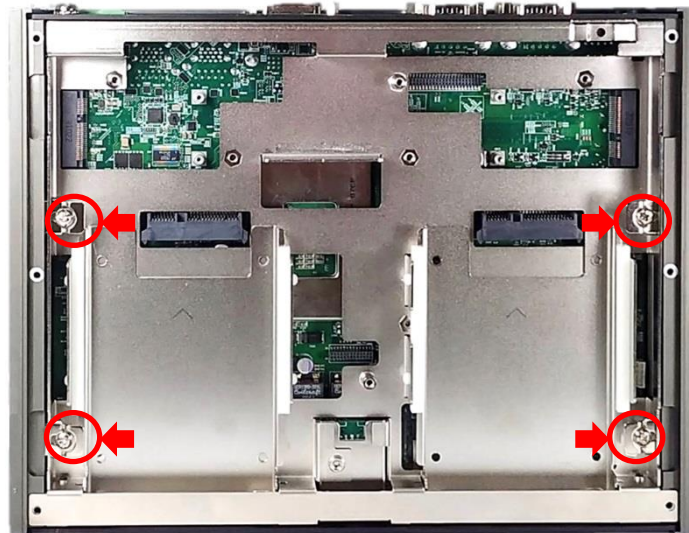

3. Put the bottom cover onto the system.



4. Fasten the 6 screws on the bottom cover.

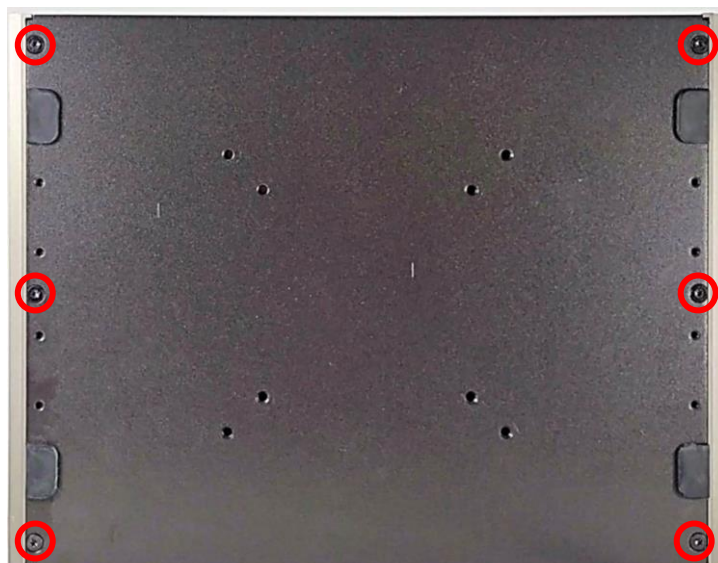

3.10 Remove the Front Cover Plate

1. Loosen the two screws to remove the front cover plate.



3.11 Install a SATA Hard Drive at Front Panel

1. Loosen the screw to remove the HDD bay cover bracket.



2. Pull the rotating arm and pull the HDD bracket out of system.

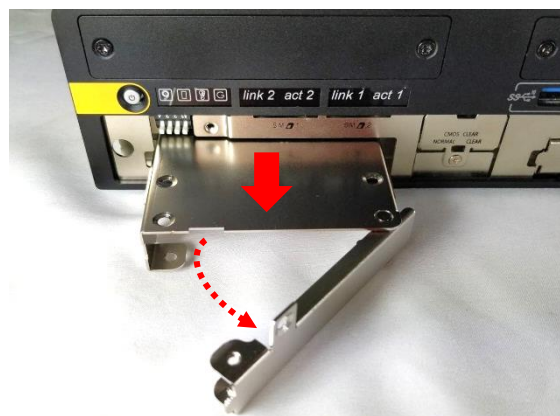

3. Make HDD bottom side face up, place the HDD bracket on it. Ensure the direction of bracket is correct and use 4 provided screws to assemble HDD and HDD bracket together.

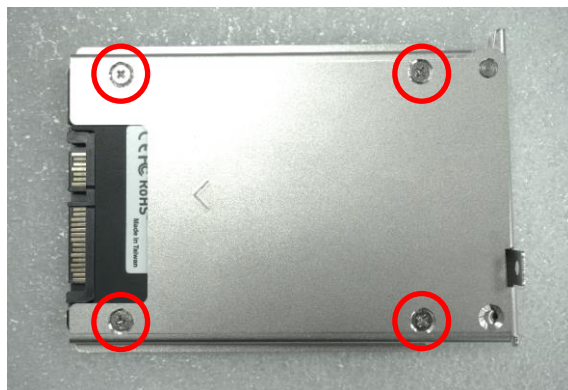

4. Align the HDD bracket with the entrance of HDD bay. Insert the HDD bracket and push it until the HDD connector is fully inserted into the SATA slot.

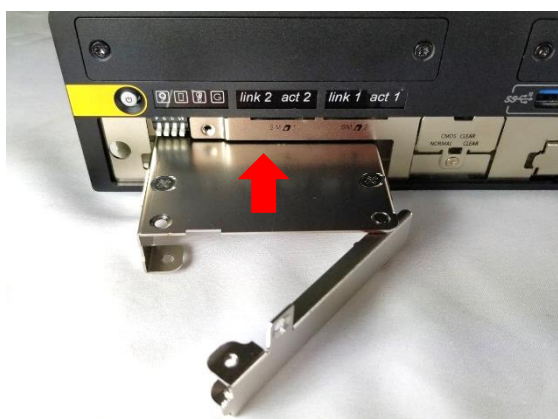

5. Place the rotating arm back and fasten the screw.



3.12 Install a SIM Card

1. Locate the SIM card slot at front side.

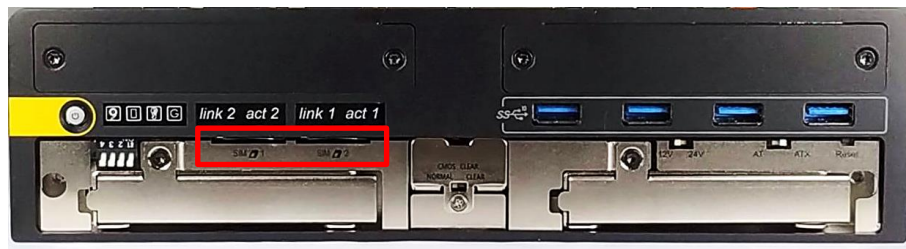

2. Insert a SIM card into SIM slot with the gold contacts facing up. Please pay attention to the insert orientation as illustrated.



3.13 Fasten the Front Cover Plate

1. Fasten the cover by using the two screws.



3.14 Wall Mount

GM-1000 series offers wall mount kit that customers can install system on the wall in convenient and economical ways.

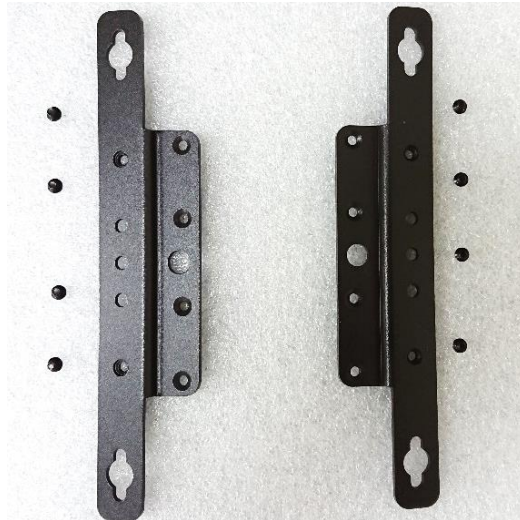

1. Locate mounting holes at the bottom side of system. Use provided 8 screws to fasten the bracket on each side.



2. There are 2 bracket mounting holes at left and right sides to fix the system on the wall.



3.15 VESA Mount

GM-1000 series supports VESA mounting that customer can mount system with VESA standards of 75 mm or 100 mm for various usages. Blue circles represent the use for VESA 75 mm. Red circles represent the use for VESA 100mm.

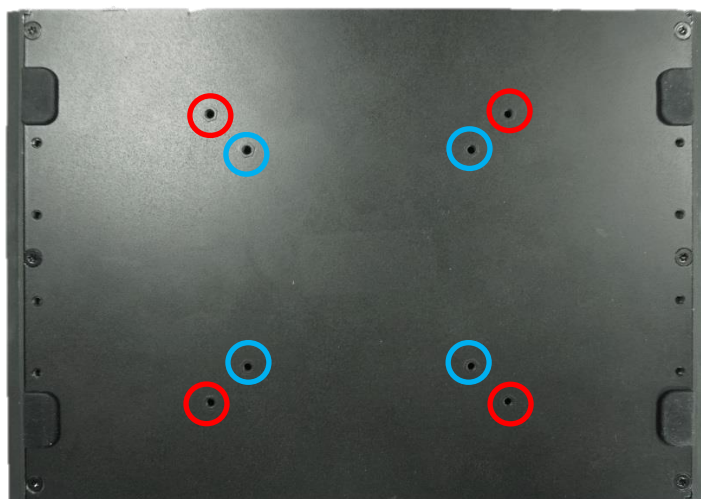

1. The following picture illustrates the installation of GM-1000 series on a VESA stand. Align the 4 screw holes of VESA stand with the screw holes on bottom side of system. Fasten 4 screws to fix it.

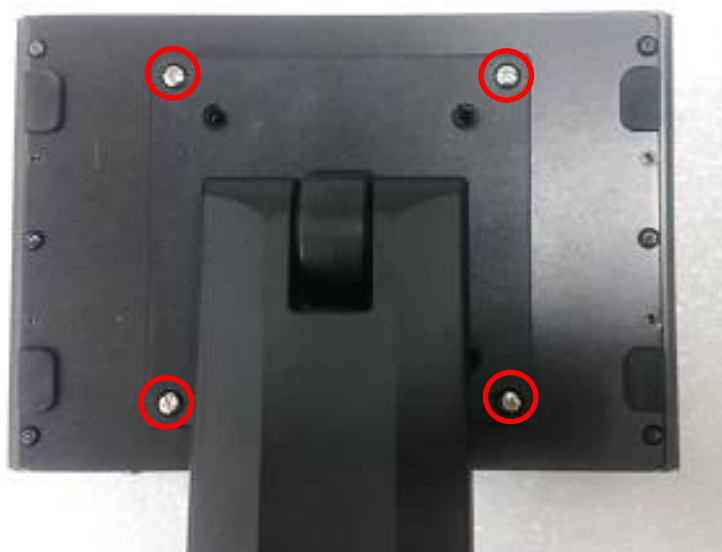

3.16 Connecting to Power Supply

1. Locate the DC_IN1 power connector.



2. Aim the V- wire at the V- port, and aim the V+ wire at the V+ port on the DC_IN connector. Then connect the phoenix contacts of the power supply to the DC_IN connector.



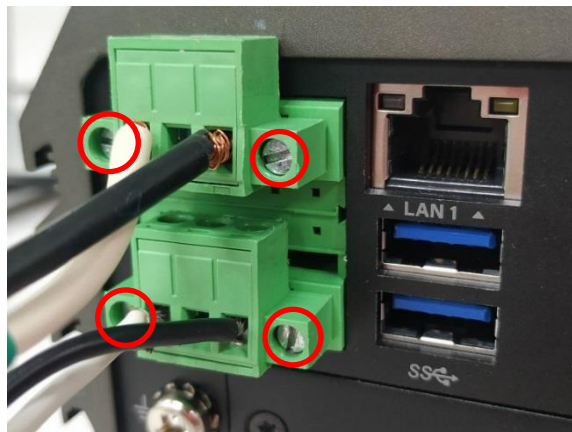

3. Fasten the four screws to fix the phoenix contacts.



CAUTION

In formal use, please use new Phoenix contacts and make sure the screws are tightened to avoid poor connection.



Chapter 4

BIOS Setup

4.1 BIOS Introduction

The BIOS (Basic Input/ Output System) is a program located on a Flash Memory on the motherboard. When you start the computer, the BIOS program will gain control. The BIOS first operates an auto-diagnostic test called POST (power on self-test) for all the necessary hardware, it detects the entire hardware device and configures the parameters of the hardware synchronization.

BIOS Setup

Power on the computer and by pressing immediately allows you to enter Setup. If the message disappears before your respond and you still wish to enter Setup, restart the system to try again by turning it OFF then ON or pressing <Ctrl>, <Alt> and <Delete> keys.

Control Keys	
<←> <→>	Move to select screen
<↑> <↓>	Move to select item
<Esc>	Quit the BIOS Setup
<Enter>	Select item
<Page Up/+>	Increases the numeric value or makes changes
<Page Down/->	Decreases the numeric value or makes changes
<Tab>	Select setup fields
<F1>	General help
<F2>	Previous value
<F3>	Load Optimized defaults
<F10>	Save configuration and Exit

Main Menu

The main menu lists the setup functions you can make changes to. You can use the arrow keys (↑↓) to select the item. The on-line description of the highlighted setup function is displayed at the bottom of the screen.

Sub-Menu

If you find a right pointer symbol appears to the left of certain fields that means a sub-menu can be launched from this field. A sub-menu contains additional options for a field parameter. You can use arrow keys (↑↓) to highlight the field and press <Enter> to call up the sub-menu. Then you can use the control keys to enter values and move from field to field within a sub-menu. If you want to return to the main menu, just press the <Esc >.

4.2 Main Setup

Press to enter BIOS CMOS Setup Utility, the Main Menu (as shown below) will appear on the screen. Use arrow keys to move among the items and press <Enter> to accept or enter a sub-menu.

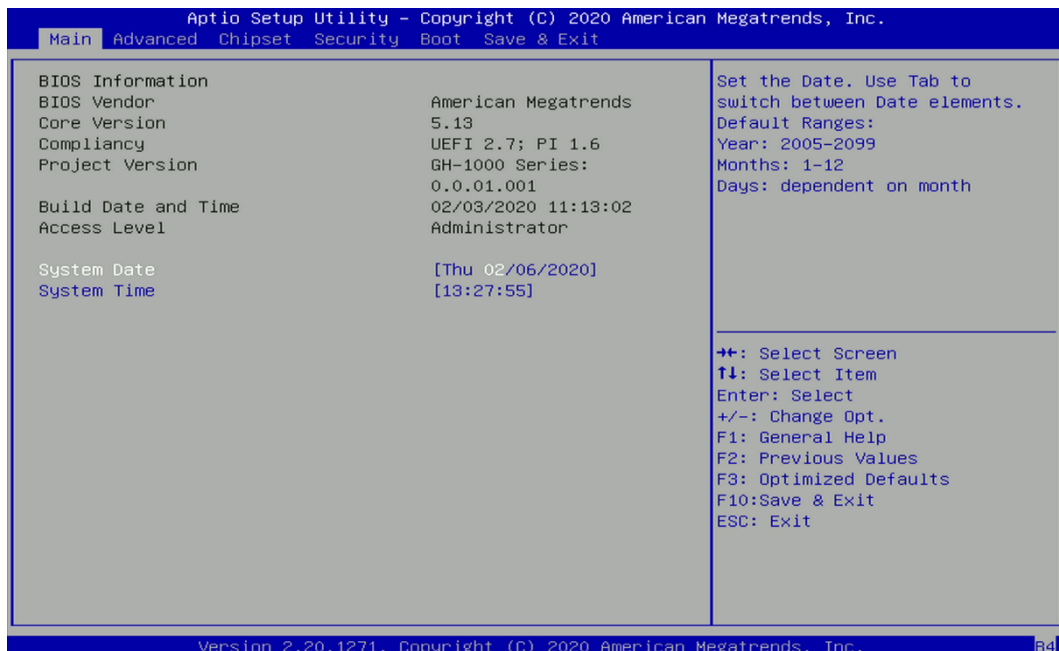

4.2.1 System Date

Set the date. Please use <Tab> to switch between date elements.

4.2.2 System Time

Set the time. Please use <Tab> to switch between time elements.

4.3 Advanced Setup

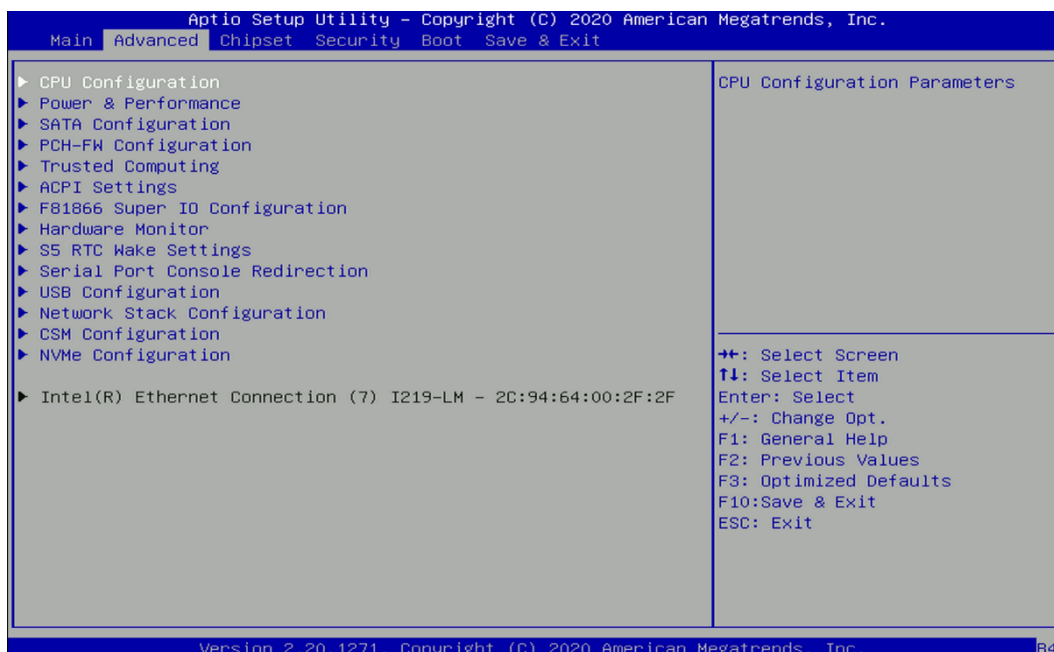

4.3.1 CPU Configuration

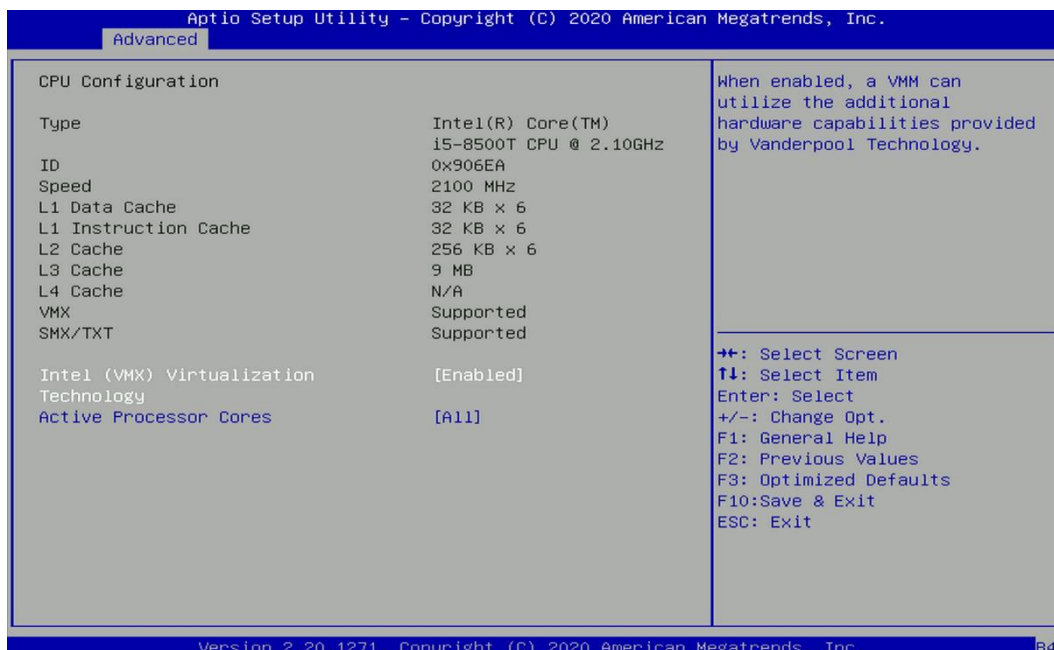

■ Intel® Virtualization Technology [Enabled]

Enables or disables Intel® Virtualization Technology. Virtualization enhanced by Intel® Virtualization Technology will allow a platform to run multiple operating systems and applications in independent partitions. With virtualization, one computer system can function as multiple virtual systems.

■ Active Process Cores [All]

Allows users to choose the number of active processor cores.

Configuration options: [All] [1] [2] [3] [4] [5]; if 6 cores CPU is used.

4.3.2 Power & Performance

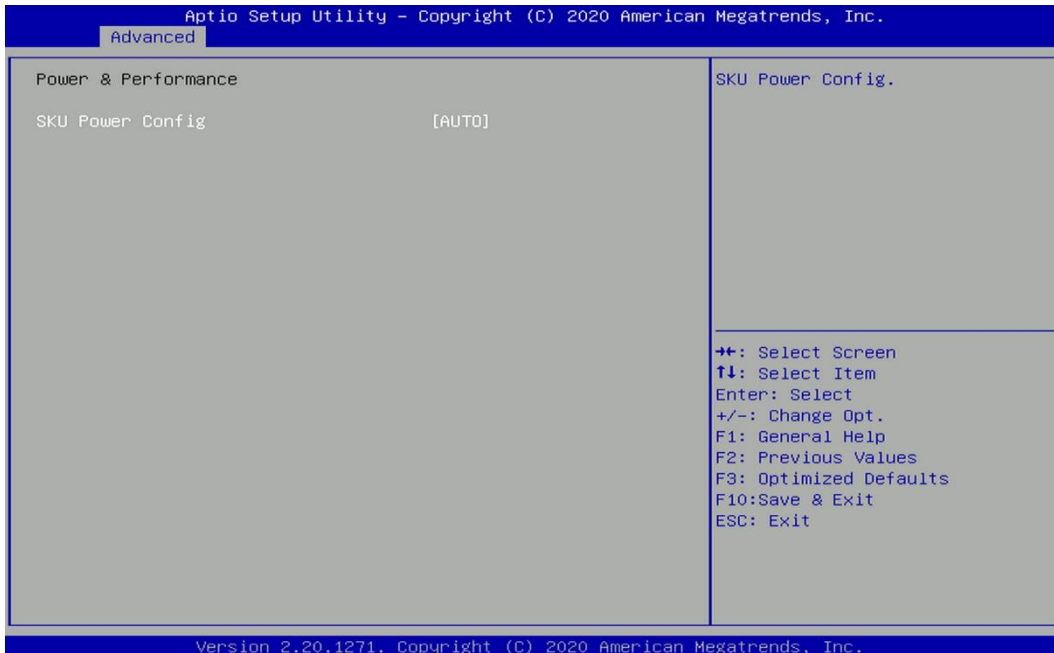

■ SKU Power Config [Auto]

Allows users to choose the upper limit of CPU power.

Configuration options: [Auto] [35W]

4.3.3 SATA Configuration

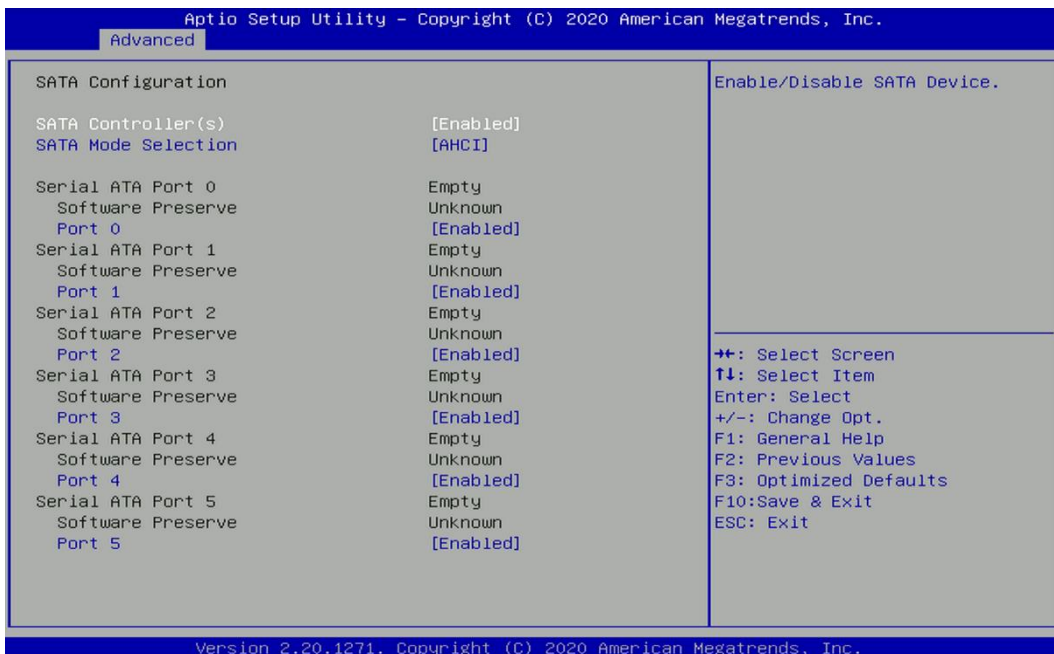

■ SATA Controller(s) [Enabled]

Enables or disables Serial ATA controller.

■ SATA Mode Selection [AHCI]

This item allows users to choose [AHCI] or [RAID] mode.

- ❑ **Serial ATA Port 0**
Port 0 [Enabled]
Enables or disables SATA Port 0.
- ❑ **Serial ATA Port 1**
Port 1 [Enabled]
Enables or disables SATA Port 1.
- ❑ **Serial ATA Port 2**
Port 1 [Enabled]
Enables or disables SATA Port 2.
- ❑ **Serial ATA Port 3**
Port 1 [Enabled]
Enables or disables SATA Port 3.
- ❑ **Serial ATA Port 4**
Port 1 [Enabled]
Enables or disables SATA Port 4.
- ❑ **Serial ATA Port 5**
Port 1 [Enabled]
Enables or disables SATA Port 5.

4.3.4 PCH-FW Configuration

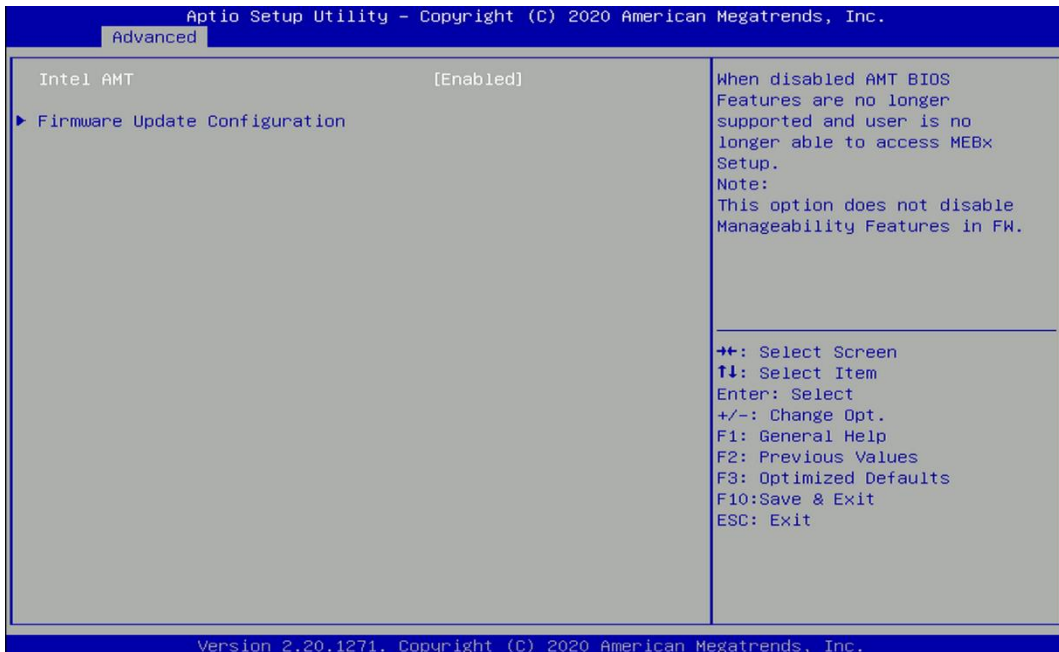

■ Intel AMT [Enabled]

Allows users to enable or disable Intel® Active Management Technology BIOS execution.

■ Firmware Update Configuration

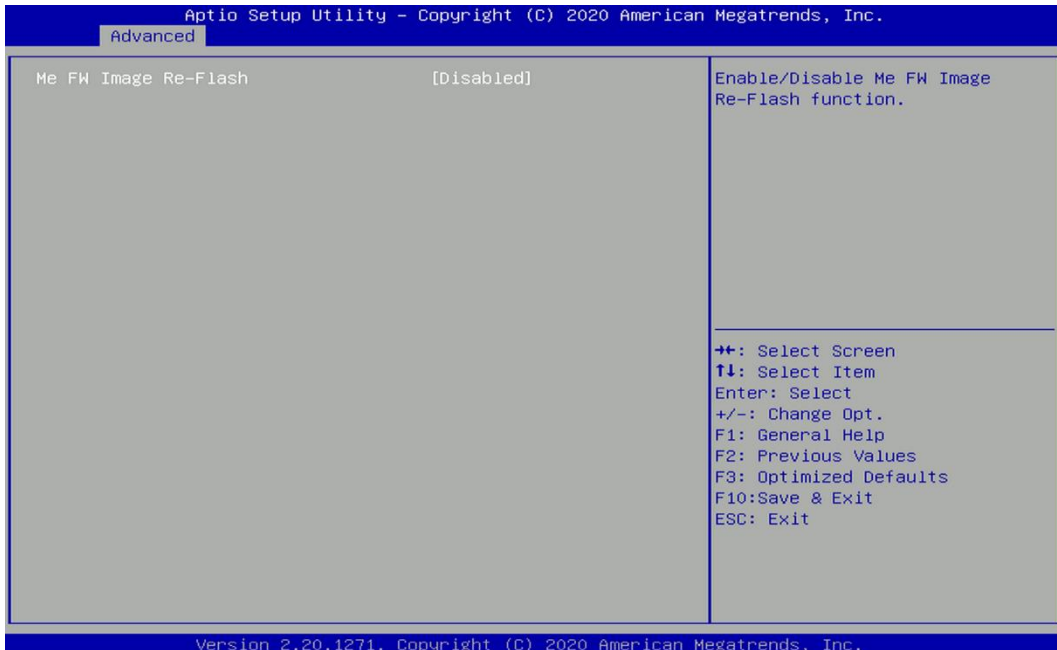

❑ ME FW Image Re-Flash [Disabled]

Allows users to enable or disable ME firmware image re-flash function.

4.3.5 Trusted Computing

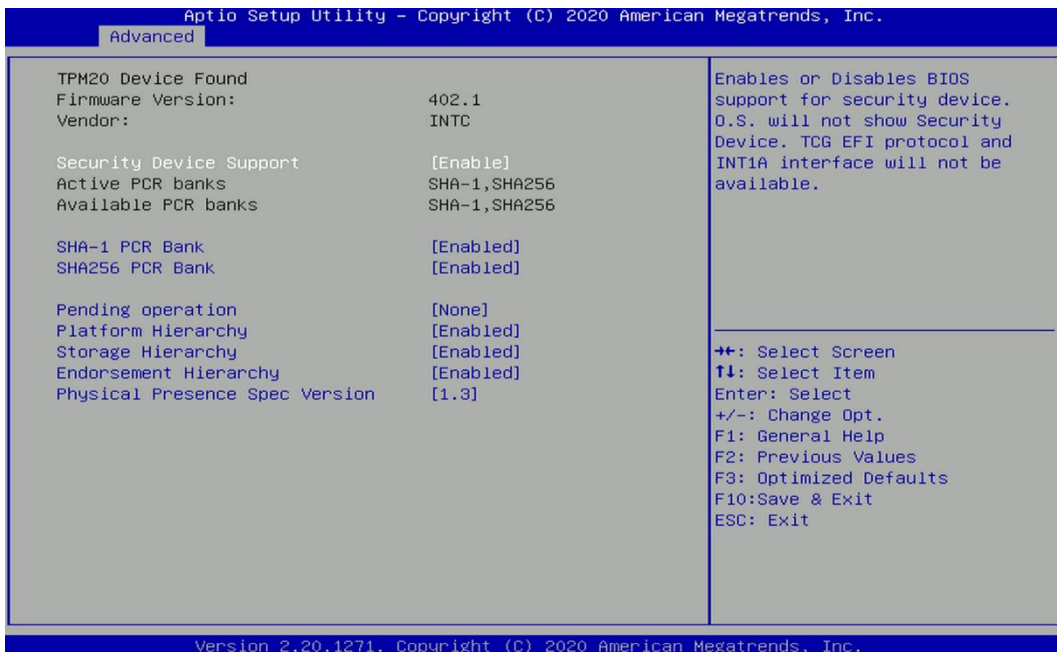

■ Security Device Support [Disable]

Allow users to enable or disable Security Device Support function.

■ SHA-1 PCR Bank [Enabled]

Enables or disables SHA-1 PCR Bank function.

■ **SHA256 PCR Bank [Enabled]**

Enables or disables SHA256 PCR Bank function.

■ **Pending Operation [None]**

Allows users to select which mode Pending Operation will operate.

Configuration options: [None], [TPM Clear]

■ **Platform Hierarchy [Enabled]**

Enables or disables Platform Hierarchy function.

■ **Storage Hierarchy [Enabled]**

Enables or disables Storage Hierarchy function.

■ **Endorsement Hierarchy [Enabled]**

Enables or disables Endorsement Hierarchy function.

■ **Physical Presence Spec Version [1.3]**

Allows users to select which mode Physical Presence Spec Version will operate.

Configuration options: [1.2], [1.3]

4.3.6 ACPI Settings

This item allows users to configure ACPI settings.

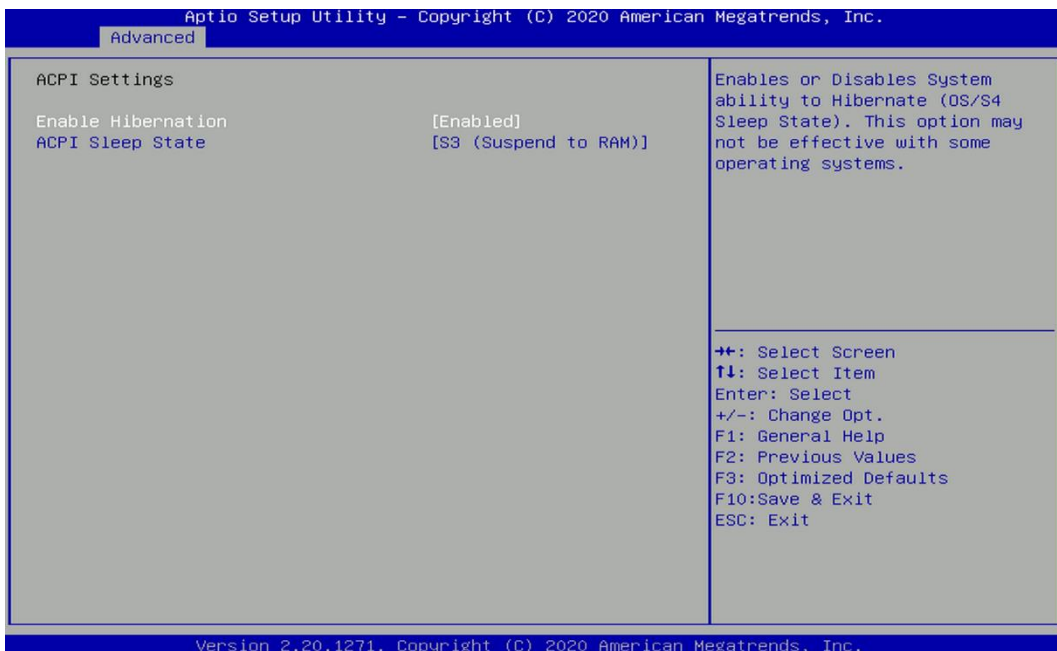

■ **Enable ACPI Auto Configuration [Enabled]**

Enables or disables BIOS Advanced Configuration Power Interface® (ACPI) auto configuration.

■ **ACPI Sleep State [S3 (Suspend to RAM)]**

Allows users to select the highest Advanced Configuration Power Interface® (ACPI) sleep state that system will enter when suspend button is pressed.

[Suspend Disabled]: Disables entering suspend state.

[S3 (suspend to RAM)]: Enables suspend to RAM state.

4.3.7 F81866 Super IO Configuration

The screen allows users to select options for the Super IO configuration, and change the value of the selected option.

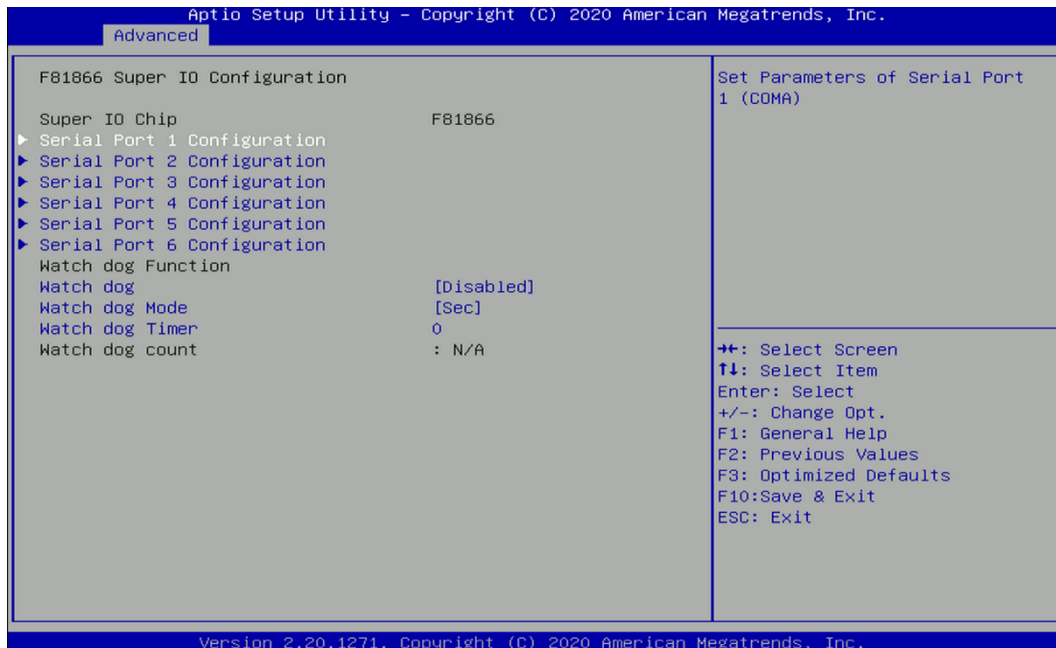

Serial Port 1~6 Configuration

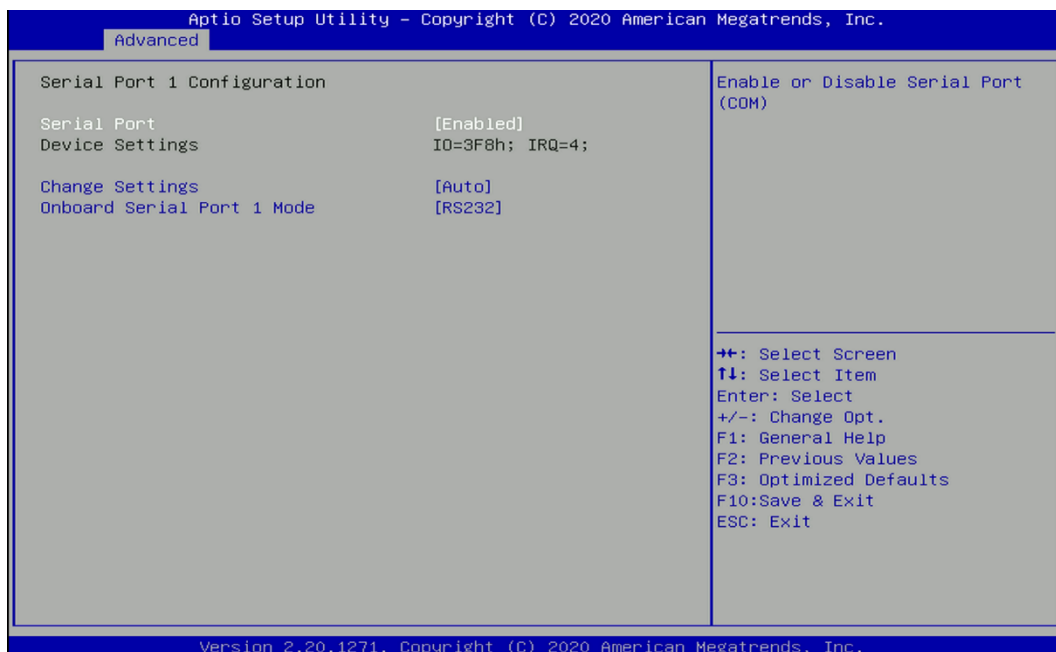

- Serial Port [Enabled]**
This item allows users to enable or disable serial port.
- Change Settings [Auto]**
This item allows users to change the address & IRQ settings of the specified serial port.

❑ **Onboard Serial Port 1 Mode [RS232]**

This item allows users to select Serial Port Mode.

Configuration options: [RS232] [RS422/RS485 Full Duplex] [RS485 Half Duplex]

■ **Watch Dog [Disabled]**

Enables or disables watch dog function.

■ **Watch Dog Mode [Sec]**

Changes the Watch dog mode. Select [Sec] or [Min] mode.

■ **Watch Dog Timer [0]**

User can set a value in the range of 0 to 255.

4.3.8 Hardware Monitor

These items display the current status of all monitored hardware devices/ components such as voltages and temperatures.

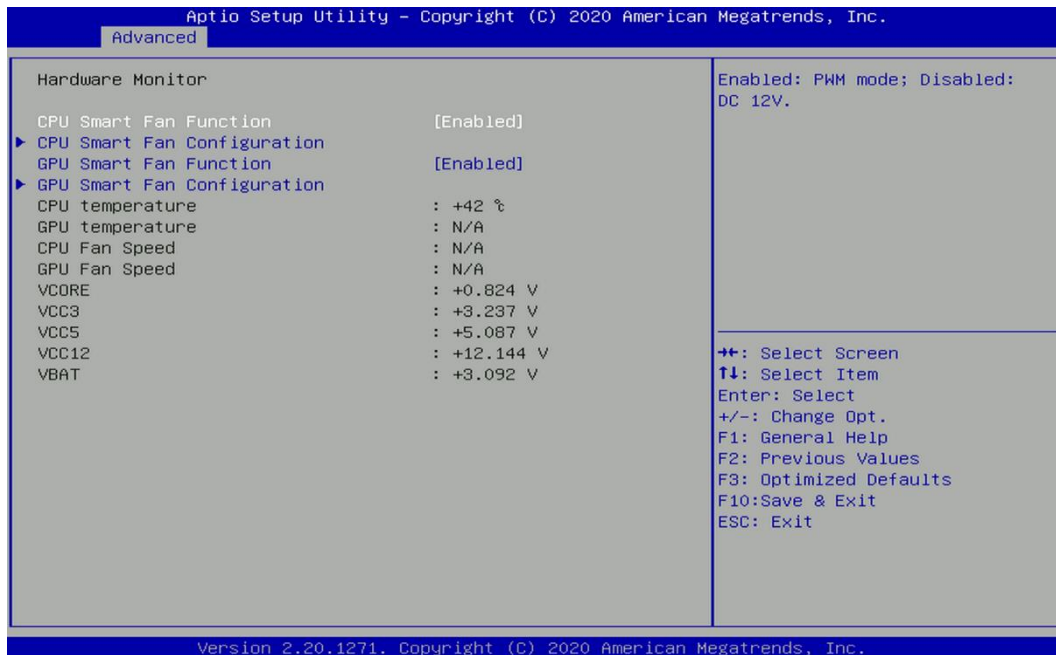

■ **CPU Smart Fan Function [Enabled]**

Enables or disables CPU Smart Fan function.

■ **CPU Smart Fan Configuration**

Allows users to setting CPU smart fan parameters.

■ **GPU Smart Fan Function [Enabled]**

Enables or disables GPU Smart Fan function.

■ **GPU Smart Fan Configuration**

Allows users to setting GPU smart fan parameters.

4.3.9 S5 RTC Wake Settings

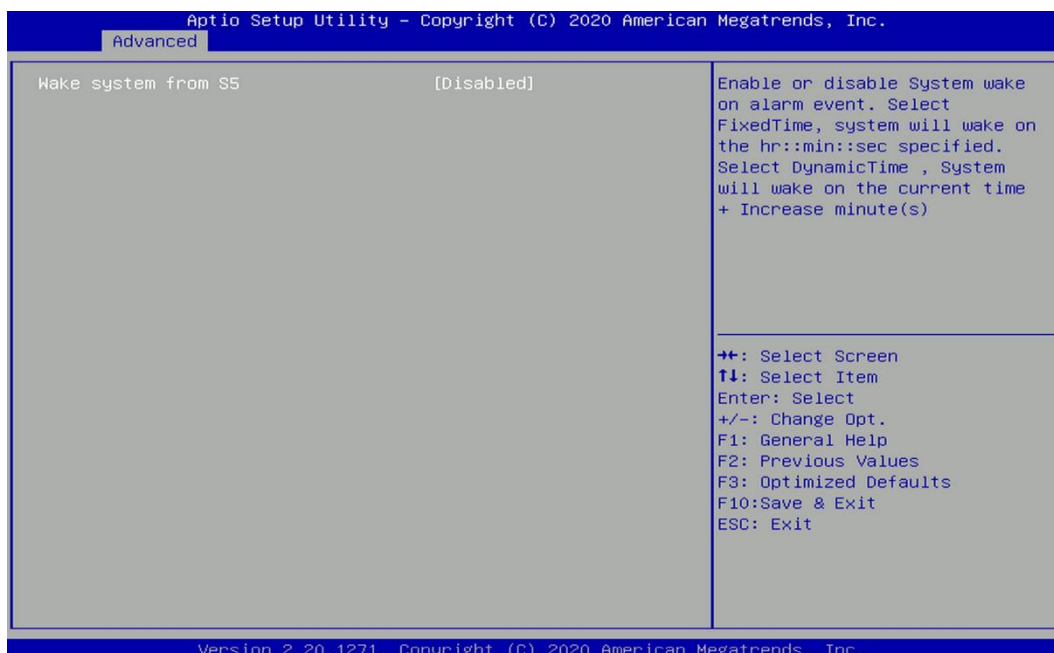

■ Wake System from S5 [Disabled]

This item allows users to change the way to wake system from S5 state.

[Fixed Time]: Set the specified time (HH:MM:SS) to wake system.

[Dynamic Time]: Set the increase time from current time to wake system.

4.3.10 Serial Port Console Redirection

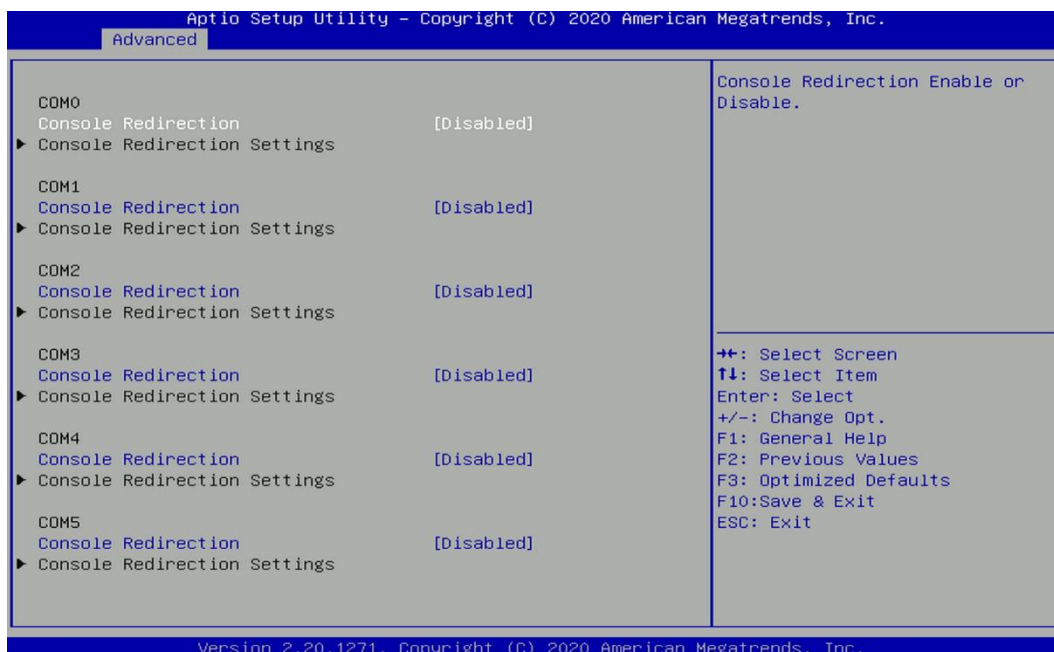

■ Console Redirection [Disabled]

These items allow users to enable or disable COM0, COM1, COM2, COM3, Com4, COM5 console redirection function.

4.3.11 USB Configuration

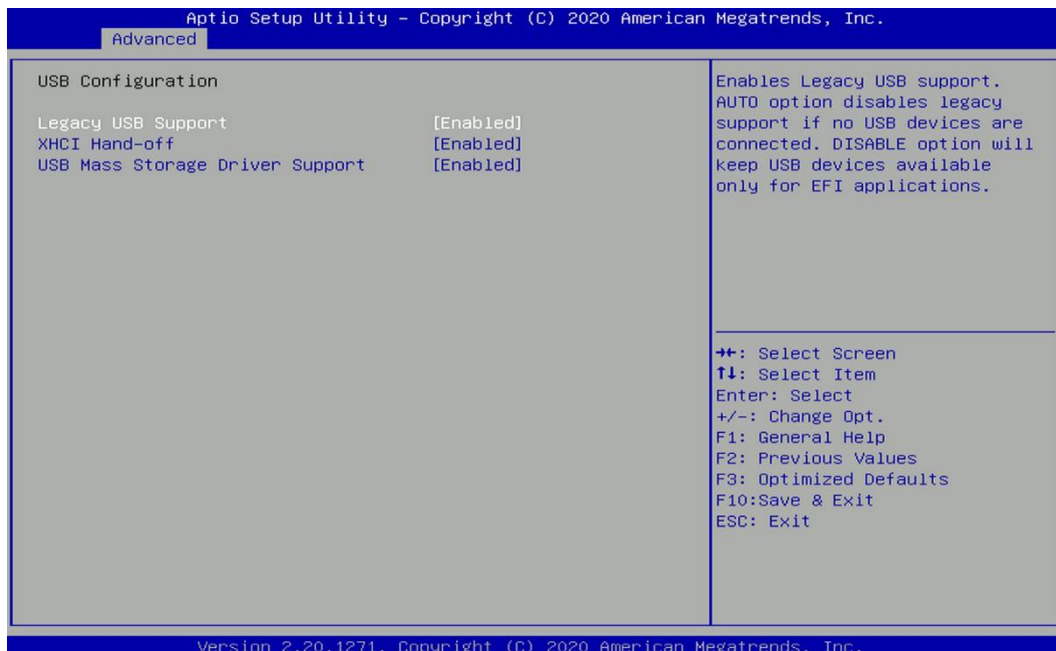

■ Legacy USB Support [Enabled]

This item allows users to enable or disable legacy USB support. When set to [Auto], legacy USB support will be disabled automatically if no USB devices are connected.

■ XHCI Hand-off [Enabled]

This item allows users to enable or disable XHCI (USB3.2) hand-off function.

■ USB Mass Storage Driver Support [Enabled]

Enables or disables support for USB mass storage devices.

4.3.12 Network Stack Configuration

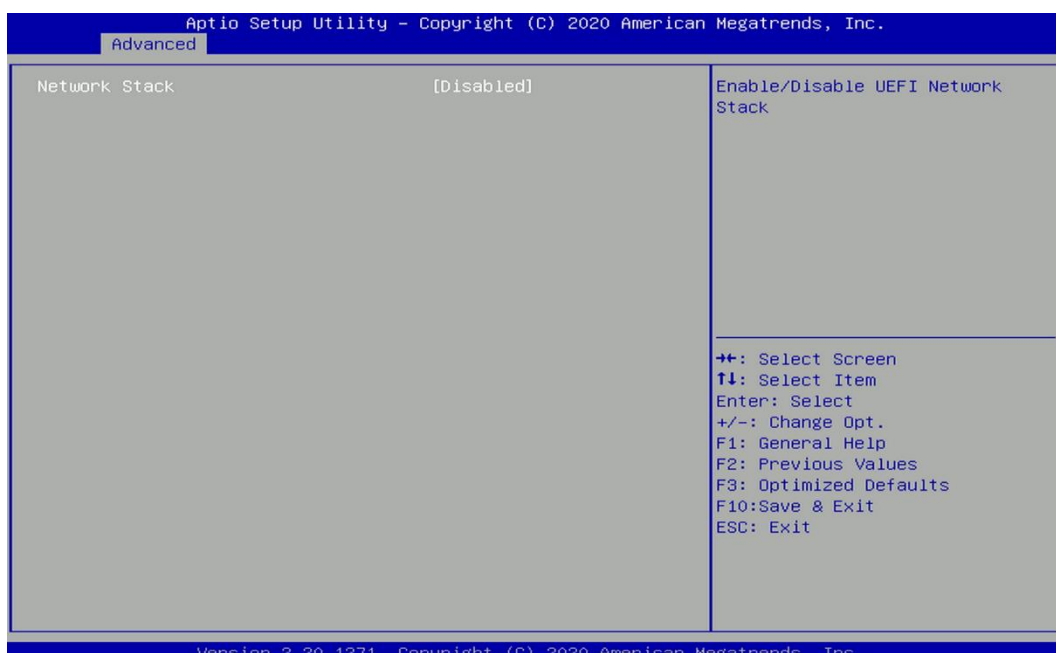

■ Network Stack [Disabled]

Enables or disables UEFI Network Stack.

4.3.13 CSM Configuration

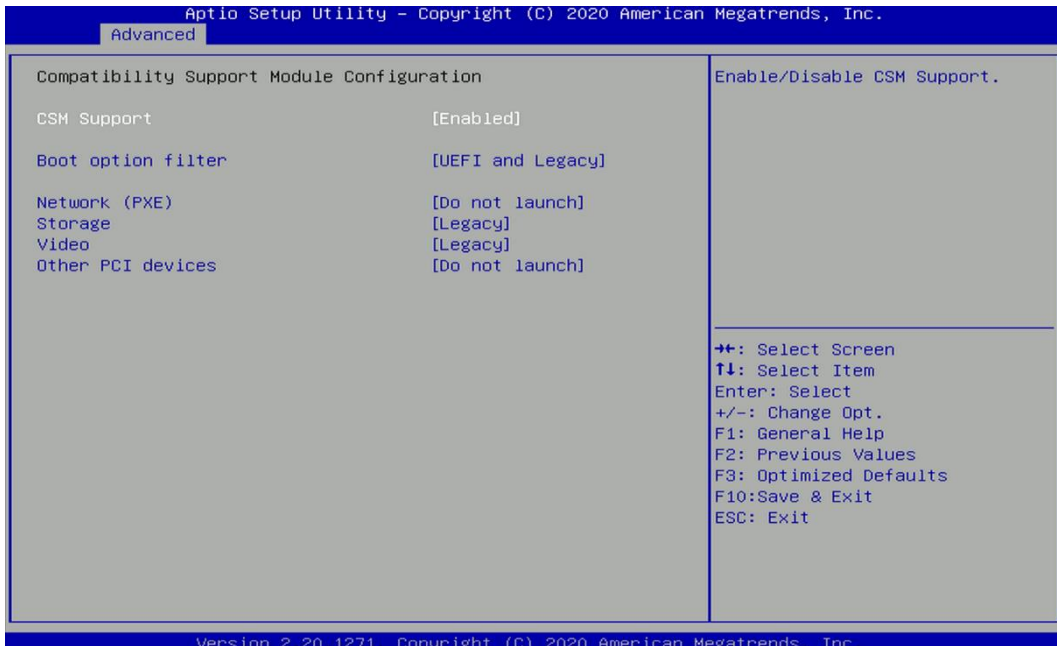

■ CSM Support [Enabled]

Enables or disables compatibility support module.

■ Boot option filter [UEFI and Legacy]

Allows users to select which type of operating system to boot.

[UEFI and Legacy]: Allows booting operating systems that support legacy or UEFI option ROM. [Legacy only]: Allows booting operating systems that only support legacy option ROM.

[UEFI only]: Allows booting operating systems that only support UEFI option ROM.

■ Network PXE [Do not launch]

Controls the execution of UEFI and Legacy PXE (Network Preboot eXecution Environment) option ROM. [Do not launch]: Disables option ROM execution.

[UEFI]: Enables UEFI option ROM only. [Legacy]: Enables legacy option ROM only.

■ Storage [Legacy]

Controls the execution of UEFI and Legacy Storage option ROM.

[Do not launch]: Disables option ROM execution.

[UEFI]: Enables UEFI option ROM only.

[Legacy]: Enables legacy option ROM only.

■ Video [Legacy]

Controls the execution of UEFI and Legacy Video option ROM.

[Do not launch]: Disables option ROM execution.

[UEFI]: Enables UEFI option ROM only.

[Legacy]: Enables legacy option ROM only.

■ Other PCI devices [Do not launch]

Allows users to determine option ROM execution policy for device other than network, storage, or video.

Configuration options: [Do not launch] [UEFI] [Legacy]

4.3.14 NVMe Configuration

The screen allows users to select options for the NVMe configuration, and change the value of the selected option. The options will show as the NVMe Device is found.

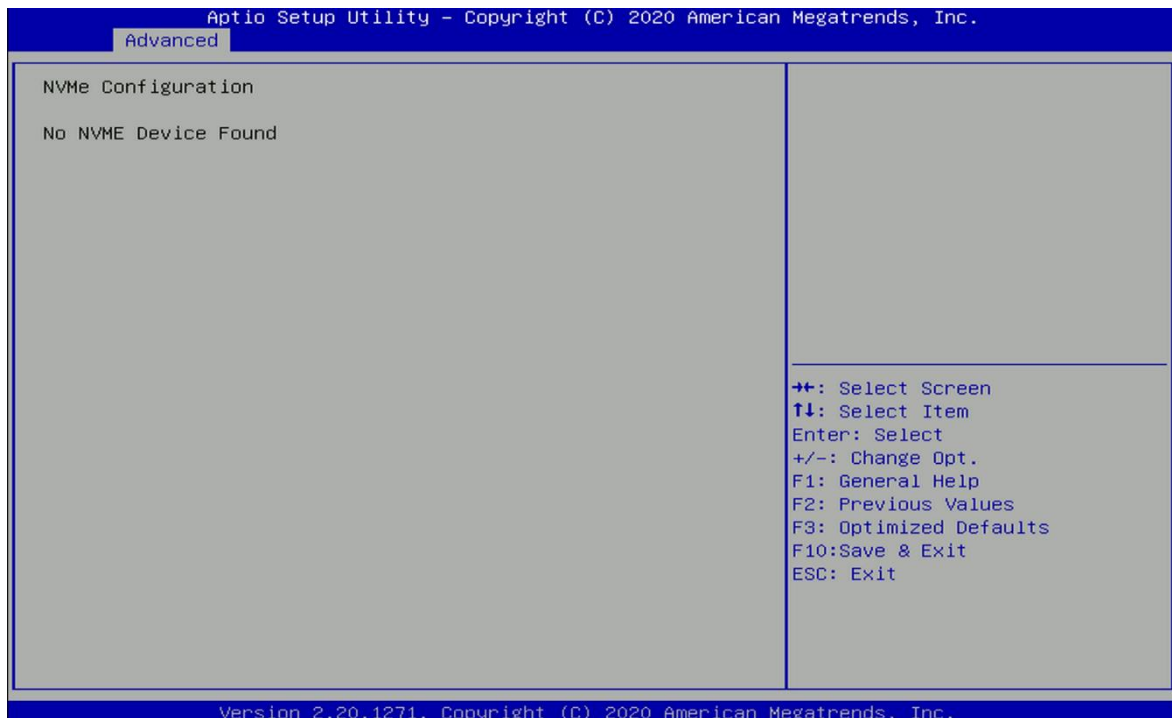

4.4 Chipset Setup

This section allows you to configure chipset related settings according to user's preference.

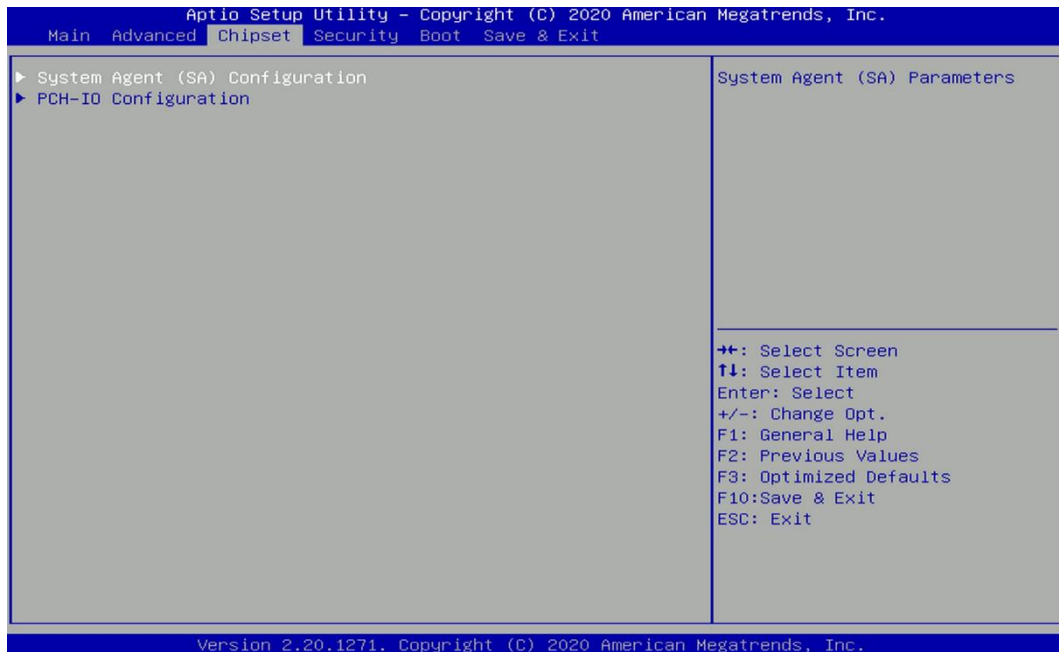

4.4.1 System Agent (SA) Configuration

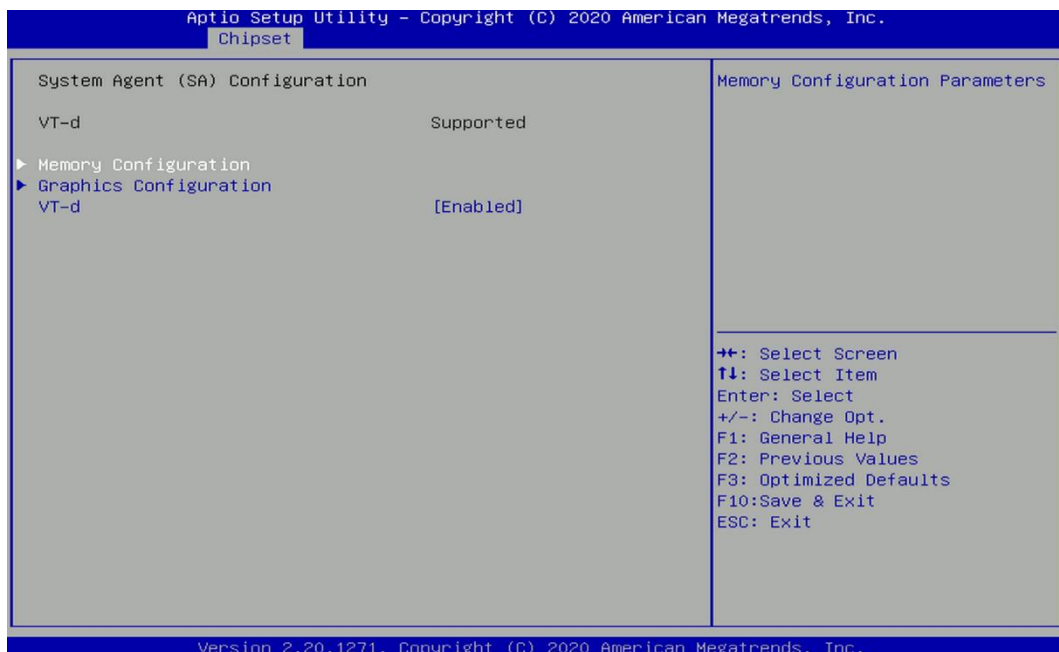

■ Memory Configuration

This item displays detailed memory information in the system.

■ Graphics Configuration

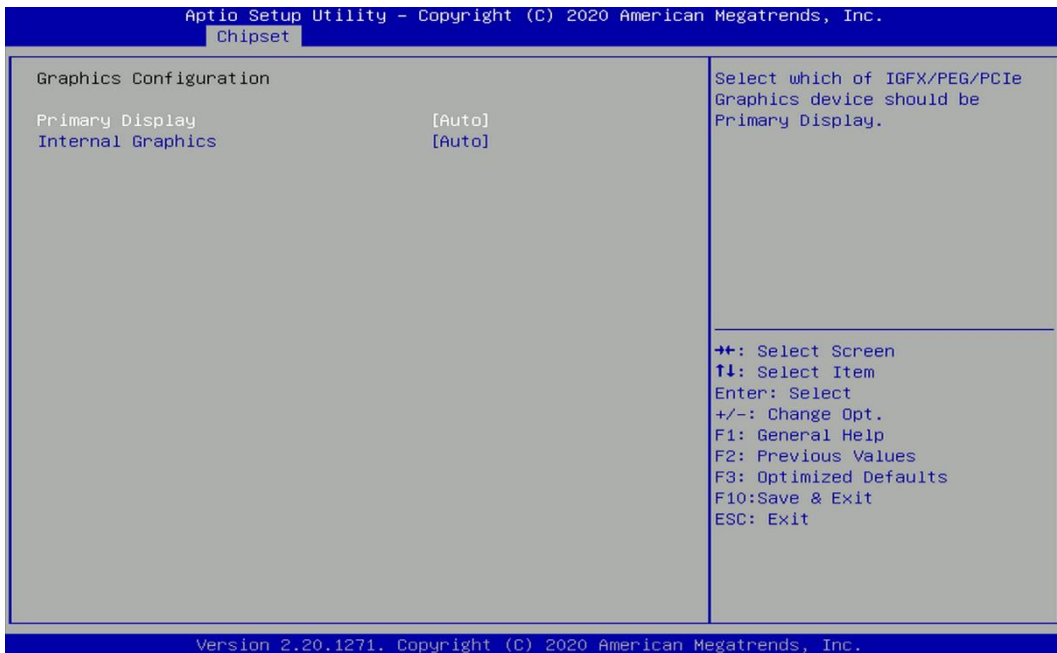

❑ Primary Display [Auto]

Allows users to select which graphics device should be primary display or select SG for switchable graphics.

Configuration options: [Auto] [IGFX] [PEG] [SG]

❑ Internal Graphics [Auto]

This item allows users to enable or disable Internal Graphics. When set to [Auto], it will detect by BIOS. Configuration options: [Auto] [Disabled] [Enabled]

■ VT-d [Enabled]

This item allows users to enable or disable Intel® Virtualization Technology for Directed I/O (VT-d) function.

4.4.2 PCH-IO Configuration

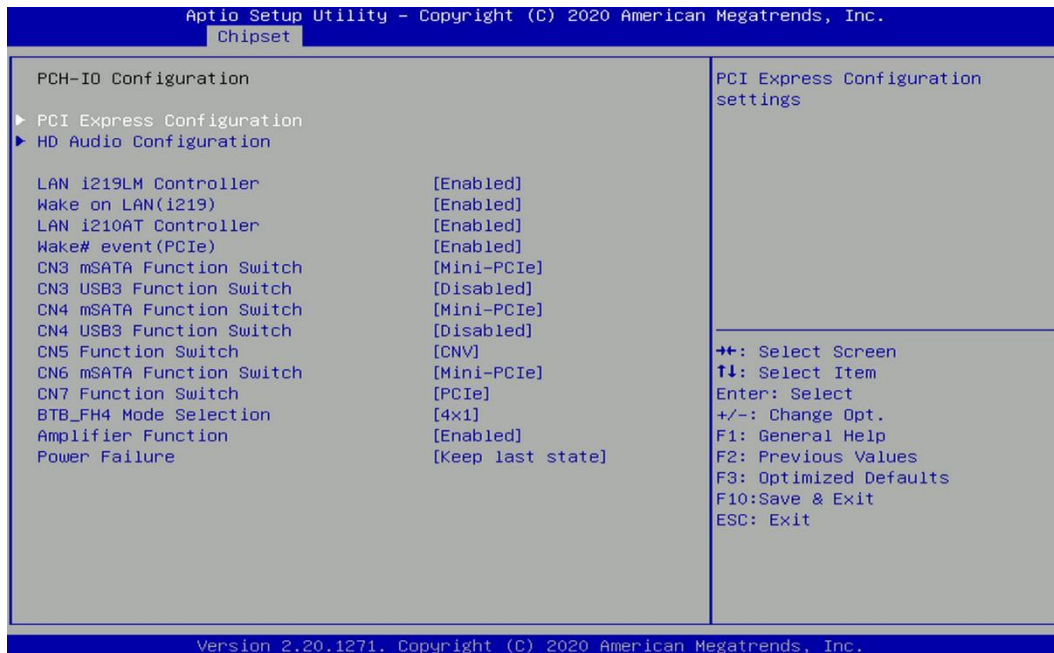

■ PCI Express Configuration



- ❑ **PCI Express Root Port (mPCIe CN3)**
 - **PCI Express Root Port [Enabled]**
Allows you to enable or disable the PCI Express Port.
 - **PCIe Speed [Auto]**
Allows you to select PCI Express interface speed.
Configuration options: [Auto] [Gen1] [Gen2] [Gen3].
- ❑ **PCI Express Root Port (mPCIe CN4)**
 - **PCI Express Root Port [Enabled]**
Allows you to enable or disable the PCI Express Port.

- **PCIe Speed [Auto]**

Allows you to select PCI Express interface speed.

Configuration options: [Auto] [Gen1] [Gen2] [Gen3].

- **PCI Express Root Port (mPCIe CN6)**

- **PCI Express Root Port [Enabled]**

Allows you to enable or disable the PCI Express Port.

- **PCIe Speed [Auto]**

Allows you to select PCI Express interface speed.

Configuration options: [Auto] [Gen1] [Gen2] [Gen3].

- **PCI Express Root Port (M.2 CN5)**

- **PCI Express Root Port [Enabled]**

Allows you to enable or disable the PCI Express Port.

- **PCIe Speed [Auto]**

Allows you to select PCI Express interface speed.

Configuration options: [Auto] [Gen1] [Gen2] [Gen3].

- **PCI Express Root Port (M.2 CN7)**

- **PCI Express Root Port [Enabled]**

Allows you to enable or disable the PCI Express Port.

- **PCIe Speed [Auto]**

Allows you to select PCI Express interface speed.

Configuration options: [Auto] [Gen1] [Gen2] [Gen3].

■ HD Audio Configuration

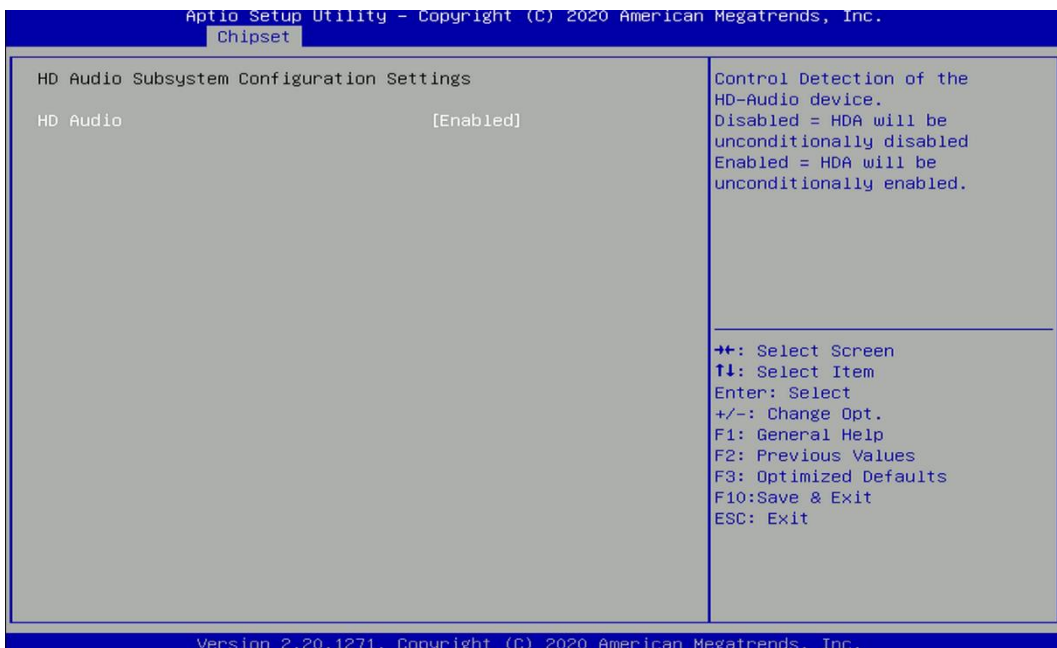

- **HD Audio [Enabled]**

Allows you to select HD Audio options.

[Enabled]: HD Audio device is unconditionally enabled.

[Disabled]: HD Audio device is unconditionally disabled.

■ **LAN i219LM Controller [Enabled]**

Enables or disables i219LM LAN Controller.

■ **Wake On LAN (i219) [Enabled]**

Enables or disables integrated LAN i219LM Wake on LAN function.

■ **LAN i210AT Controller [Enabled]**

Enables or disables I210 LAN Controller.

■ **Wake# event (PCIe) [Enabled]**

Enables or disables integrated LAN I210 Wake on LAN function.

■ **CN3 mSATA function Switch [Mini-PCIe]**

Allows users to select [Mini-PCIe] or [mSATA] for CN3 connector.

■ **CN3 USB3 Function Switch [Disabled]**

Enables or disables CN3 USB3 Controller.

■ **CN4 mSATA function Switch [Mini-PCIe]**

Allows users to select [Mini-PCIe] or [mSATA] for CN4 connector.

■ **CN4 USB3 Function Switch [Disabled]**

Enables or disables CN4 USB3 Controller.

■ **CN5 Function Switch [CNV]**

Allows users to select [CNV] or [WiFi] for CN5 connector.

■ **CN6 mSATA function Switch [Mini-PCIe]**

Allows users to select [Mini-PCIe] or [mSATA] for CN6 connector.

■ **CN7 function Switch [PCIe]**

Allows users to select [PCIe] or [SATA] for CN7 connector.

■ **BTB_FH4 Mode Selection [4x1]**

Allows users to select [4x1] or [1x4] for BTB_FH4 Mode.

■ **Power Over Ethernet Function [Disabled]**

Enable or disable Power Over Ethernet (POE) function.

■ **Power Failure [Keep last state]**

Allows you to specify which power state system will enter when power is resumed after a power failure (G3 state).

[Always on]: Enters to power on state.

[Always off]: Enters to power off state.

[Keep last state]: Enters to the last power state before a power failure.

4.5 Security Setup

This section allows users to configure BIOS security settings.

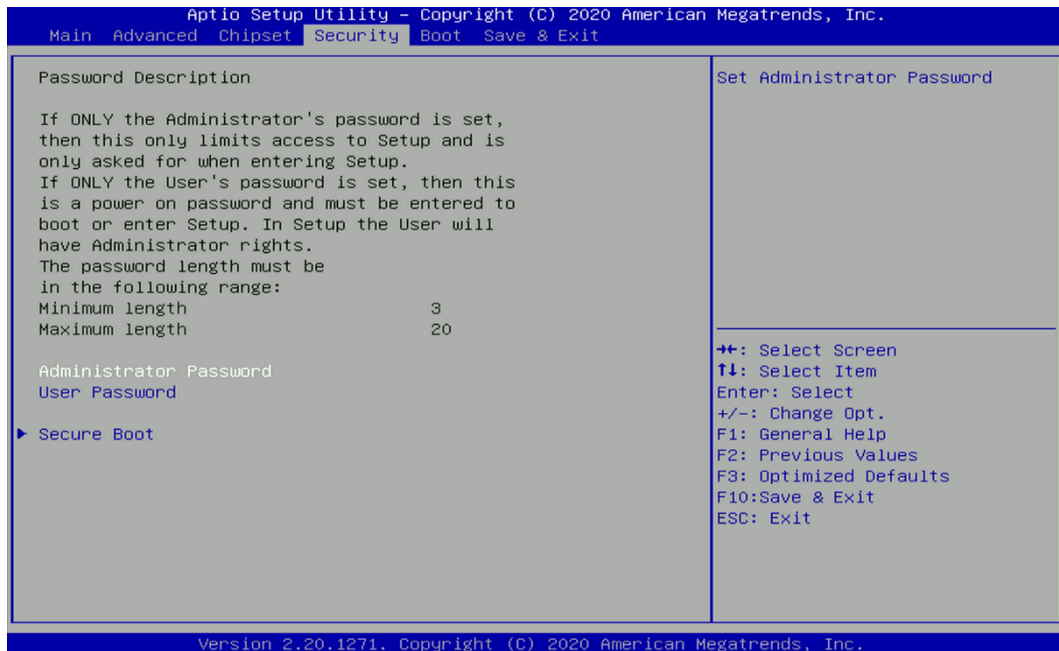

4.5.1 Administrator Password

Administrator Password controls access to the BIOS Setup utility.

4.5.2 User Password

User Password controls access to the system at boot and to the BIOS Setup utility.

4.5.3 Security Boot

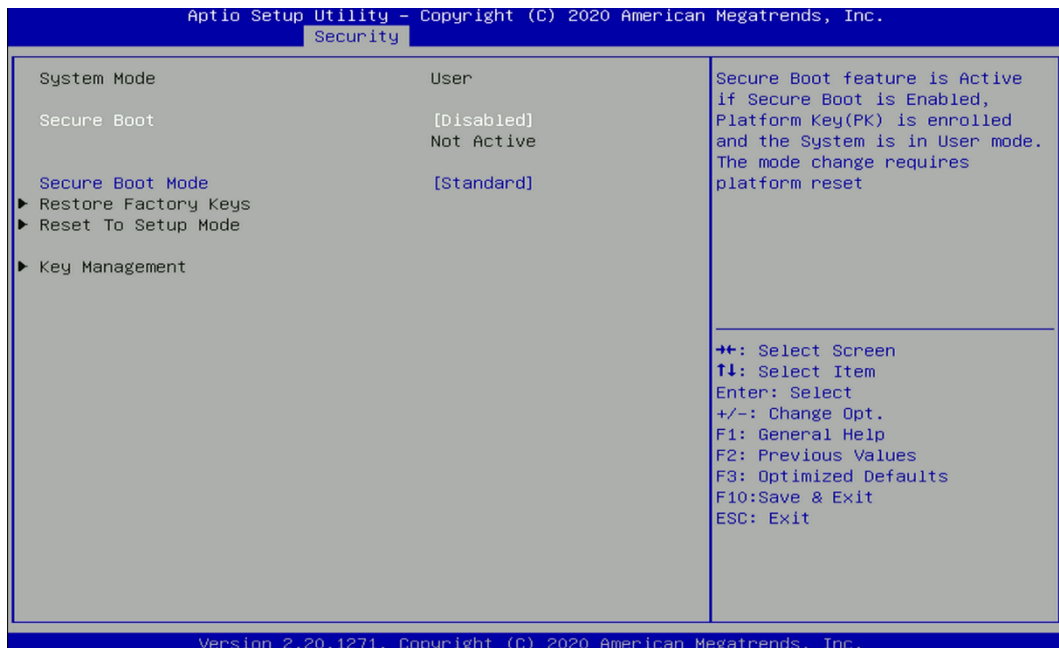

- Secure Boot [Disabled]**
Enable or disable Secure Boot function.
- Secure Boot Mode [Standard]**

Allows you to select Secure Boot Mode.
Configuration options: [Standard] [Custom].

4.6 Boot Setup

This section allows you to configure Boot settings.

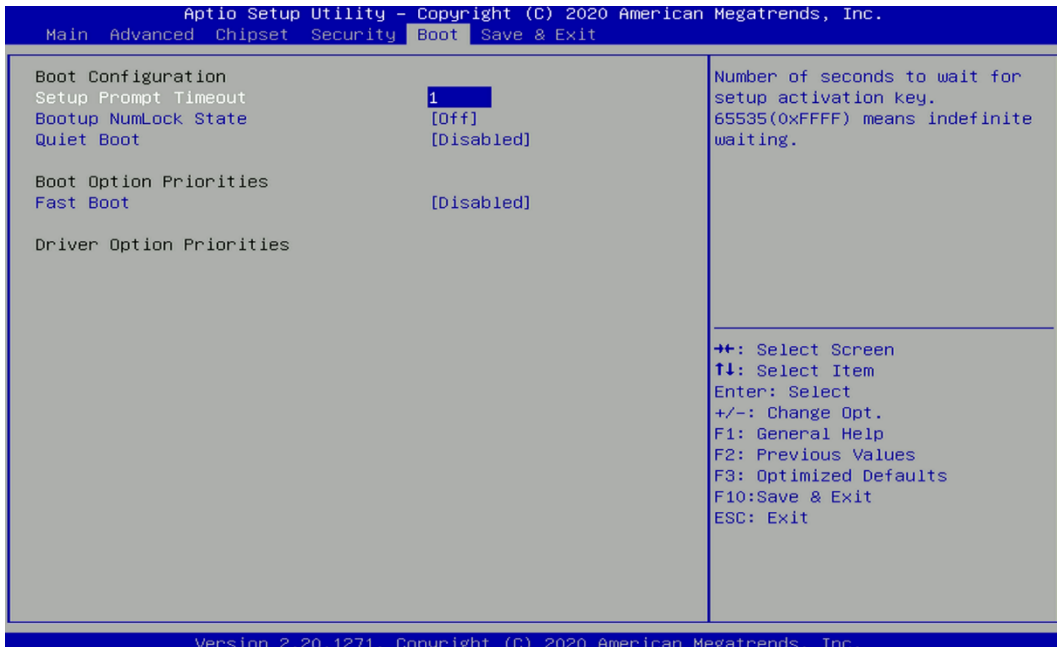

4.6.1 Setup Prompt Timeout [1]

Use this item to set number of seconds (1..65535) to wait for setup activation key.

4.6.2 Bootup NumLock State [Off]

Allows users to select the power-on state for keyboard NumLock.

4.6.3 Quiet Boot [Disabled]

Allows users to enable or disable Quiet Boot function.

4.6.4 Fast Boot [Disabled]

Allows users to enable or disable Fast Boot function.

4.7 Save & Exit

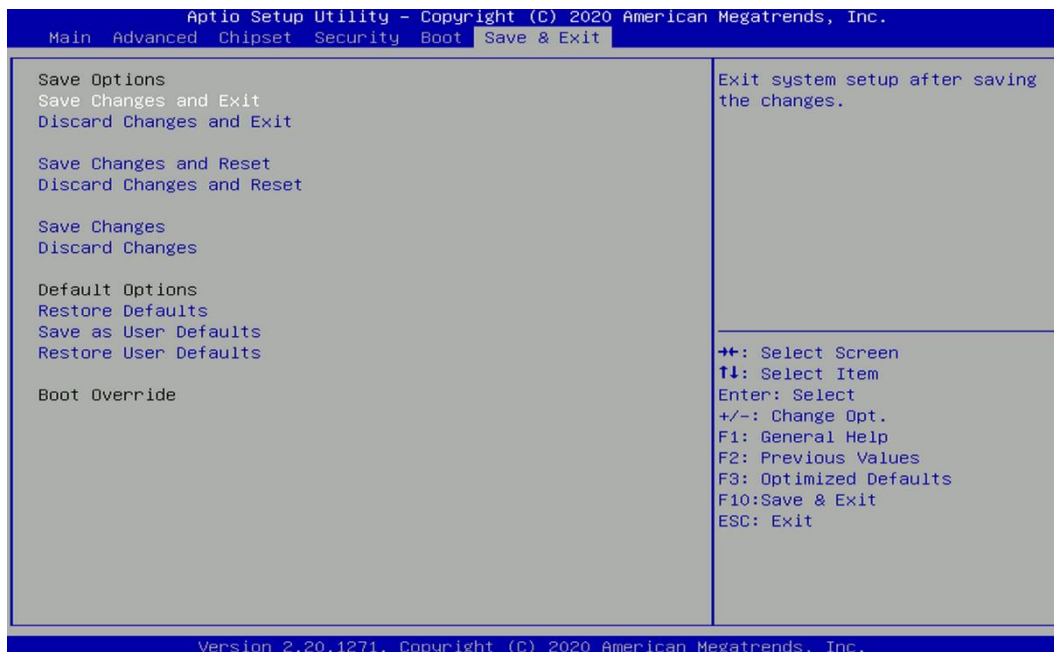

4.7.1 Save Changes and Exit

This item allows users to exit system setup after saving changes.

4.7.2 Discard Changes and Exit

This item allows users to exit system setup without saving changes.

4.7.3 Save Changes and Reset

This item allows users to reset the system after saving changes.

4.7.4 Discard Changes and Reset

This item allows users to reset system setup without saving any changes.

4.7.5 Save Changes

This item allows users to save changes done so far to any of the setup options.

4.7.6 Discard Changes

This item allows users to discard changes done so far to any of the setup options.

4.7.7 Restore Defaults

This item allows users to restore/ load default values for all the options.

4.7.8 Save as User Defaults

This item allows users to save the changes done so far as user defaults.

4.7.9 Restore User Defaults

This item allows users to restore the user defaults to all the options.



Chapter 5

Product Application

(For CMI-DIO01 Only)

5.1 Digital I/O (DIO) application

This section describes DIO application of the product. The content and application development are better understood and implemented by well experienced professionals or developers.

5.1.1 Digital I/O Programming Guide

5.1.1.1 Pins for Digital I/O

Item	Standard
GPIO70 (Pin103)	DI
GPIO71 (Pin104)	
GPIO72 (Pin105)	
GPIO73 (Pin106)	
GPIO74 (Pin107)	
GPIO75 (Pin108)	
GPIO76 (Pin109)	
GPIO77 (Pin110)	
GPIO80 (Pin111)	DO
GPIO81 (Pin112)	
GPIO82 (Pin113)	
GPIO83 (Pin114)	
GPIO84 (Pin115)	
GPIO85 (Pin116)	
GPIO86 (Pin117)	
GPIO87 (Pin118)	

5.1.1.2 Programming Guide

To program the Super I/O chip F81866A configuration registers, the following configuration procedures must be followed in sequence:

- (1) Enter the Extended Function Mode
- (2) Configure the configuration registers
- (3) Exit the Extended Function Mode

The configuration register is used to control the behavior of the corresponding devices. To configure the register, use the index port to select the index and then write data port to alter the parameters. The default index port and data port are 0x4E and 0x4F, respectively.

Pull down the SOUT1 pin to change the default value to 0x2E/ 0x2F. To enable configuration, the entry key 0x87 must be written to the index port. To disable configuration, write exit entry key 0xAA to the index port.

Following is an example to enable configuration and to disable configuration by using debug.

- o 4e 87
- o 4e 87 (enable configuration)
- o 4e aa (disable configuration)

5.1.1.3 Relative Registers

To program the F81866A configuration registers, see the following configuration procedures.

Logic Device Number Register (LDN) — Index 07h

Bit	Name	R/W	Reset	Default	Description
7-0	LDN	R/W	LRESET#	00h	00h: Select FDC device configuration registers. 03h: Select Parallel Port device configuration registers. 04h: Select Hardware Monitor device configuration registers. 05h: Select KBC device configuration registers. 06h: Select GPIO device configuration registers. 07h: Select WDT device configuration registers. 0Ah: Select PME, ACPI and ERP device configuration registers. 10h: Select UART1 device configuration registers. 11h: Select UART2 device configuration registers. 12h: Select UART3 device configuration registers. 13h: Select UART4 device configuration registers. 14h: Select UART5 device configuration registers. 15h: Select UART6 device configuration registers. Otherwise: Reserved.

7.7.11.1GPIO7 Output Enable Register — Index 80h

Bit	Name	R/W	Reset	Default	Description
7	GPIO77_OE	R/W	LRESET#	0	0: GPIO77 is in input mode. 1: GPIO77 is in output mode.
6	GPIO76_OE	R/W	LRESET#	0	0: GPIO76 is in input mode. 1: GPIO75 is in output mode.
5	GPIO75_OE	R/W	LRESET#	0	0: GPIO75 is in input mode. 1: GPIO75 is in output mode.
4	GPIO74_OE	R/W	LRESET#	0	0: GPIO74 is in input mode. 1: GPIO74 is in output mode.
3	GPIO73_OE	R/W	LRESET#	0	0: GPIO73 is in input mode. 1: GPIO73 is in output mode.
2	GPIO72_OE	R/W	LRESET#	0	0: GPIO72 is in input mode. 1: GPIO72 is in output mode.
1	GPIO71_OE	R/W	LRESET#	0	0: GPIO71 is in input mode. 1: GPIO71 is in output mode.
0	GPIO70_OE	R/W	LRESET#	0	0: GPIO70 is in input mode. 1: GPIO70 is in output mode.

8.7.13.3GPIO7 Pin Status Register — Index 82h (This byte could be also read by base address + 3)

Bit	Name	R/W	Reset	Default	Description
7	GPIO77_IN	R	-	-	The pin status of GPIO77/STB#.
6	GPIO76_IN	R	-	-	The pin status of GPIO76/AFD#.
5	GPIO75_IN	R	-	-	The pin status of GPIO75/ERR#.
4	GPIO74_IN	R	-	-	The pin status of GPIO74/INIT#.
3	GPIO73_IN	R	-	-	The pin status of GPIO73/SLIN#.
2	GPIO72_IN	R	-	-	The pin status of GPIO72/ACK#.
1	GPIO71_IN	R	-	-	The pin status of GPIO71/BUSY.
0	GPIO70_IN	R	-	-	The pin status of GPIO70/PE/FANCTL3/PWM_DAC3.

7.7.12.1GPIO8 Output Enable Register — Index 88h

Bit	Name	R/W	Reset	Default	Description
7	GPIO87_OE	R/W	LRESET#	0	0: GPIO87 is in input mode. 1: GPIO87 is in output mode.
6	GPIO86_OE	R/W	LRESET#	0	0: GPIO86 is in input mode. 1: GPIO85 is in output mode.

5	GPIO85_OE	R/W	LRESET#	0	0: GPIO85 is in input mode. 1: GPIO85 is in output mode.
4	GPIO84_OE	R/W	LRESET#	0	0: GPIO84 is in input mode. 1: GPIO84 is in output mode.
3	GPIO83_OE	R/W	LRESET#	0	0: GPIO83 is in input mode. 1: GPIO83 is in output mode.
2	GPIO82_OE	R/W	LRESET#	0	0: GPIO82 is in input mode. 1: GPIO82 is in output mode.
1	GPIO81_OE	R/W	LRESET#	0	0: GPIO81 is in input mode. 1: GPIO81 is in output mode.
0	GPIO80_OE	R/W	LRESET#	0	0: GPIO80 is in input mode. 1: GPIO80 is in output mode.

7.7.12.2 GPIO8 Output Data Register — Index 89h (This byte could be also written by base address + 2)

Bit	Name	R/W	Reset	Default	Description
7	GPIO87_VAL	R/W	LRESET#	1	0: GPIO87 outputs 0 when in output mode. 1: GPIO87 outputs 1 when in output mode.
6	GPIO86_VAL	R/W	LRESET#	1	0: GPIO86 outputs 0 when in output mode. 1: GPIO86 outputs 1 when in output mode.
5	GPIO85_VAL	R/W	LRESET#	1	0: GPIO85 outputs 0 when in output mode. 1: GPIO85 outputs 1 when in output mode.
4	GPIO84_VAL	R/W	LRESET#	1	0: GPIO84 outputs 0 when in output mode. 1: GPIO84 outputs 1 when in output mode.
3	GPIO83_VAL	R/W	LRESET#	1	0: GPIO83 outputs 0 when in output mode. 1: GPIO83 outputs 1 when in output mode.
2	GPIO82_VAL	R/W	LRESET#	1	0: GPIO82 outputs 0 when in output mode. 1: GPIO82 outputs 1 when in output mode.
1	GPIO81_VAL	R/W	LRESET#	1	0: GPIO81 outputs 0 when in output mode. 1: GPIO81 outputs 1 when in output mode.
0	GPIO80_VAL	R/W	LRESET#	1	0: GPIO80 outputs 0 when in output mode. 1: GPIO80 outputs 1 when in output mode.

5.1.1.4 Sample Code in C Language

5.1.1.4.1 Control of GP70 to GP77

```
#define AddrPort 0x4E
```

```
#define DataPort 0x4F
```

<Enter the Extended Function Mode>

```
WriteByte(AddrPort, 0x87)
```

```
WriteByte(AddrPort, 0x87) // Must write twice to enter Extended mode
```

<Select Logic Device>

```
WriteByte(AddrPort, 0x07)
```

```
WriteByte(dataPort, 0x06) // Select logic device 06h
```

<Output/Input Mode Selection> // Set GP70 to GP77 input Mode

```
WriteByte(AddrPort, 0x80) // Select configuration register 80h
```

```
WriteByte(DataPort, 0x0X) // Set (bit 0~7) = 0 to select GP 70~77 as Input mode.
```

<Input Value>

```
WriteByte(AddrPort, 0x82) // Select configuration register 82h
```

```
ReadByte(DataPort, Value) // Read bit 0~7 (0xFF)= GP70 ~77 as High.
```

<Leave the Extended Function Mode>

```
WriteByte(AddrPort, 0xAA)
```

5.1.1.4.2 Control of GP80 to GP87

```
#define AddrPort 0x4E
```

```
#define DataPort 0x4F
```

<Enter the Extended Function Mode>

```
WriteByte(AddrPort, 0x87)
```

```
WriteByte(AddrPort, 0x87) // Must write twice to enter Extended mode
```

<Select Logic Device>

```
WriteByte(AddrPort, 0x07)
```

```
WriteByte(DataPort, 0x06) // Select logic device 06h
```

<Output/Input Mode Selection> // Set GP80 to GP87 output Mode

```
WriteByte(AddrPort, 0x88) // Select configuration register 88h
```

```
WriteByte(DataPort, 0xFF) // Set (bit 0~7) = 1 to select GP 80 ~87 as Output mode.
```

<Output Value>

```
WriteByte(AddrPort, 0x89) // Select configuration register 89h
```

```
WriteByte(DataPort, Value) // Set bit 0~7=(0/1) to output GP 80~87 as Low or High
```

<Leave the Extended Function Mode>

```
WriteByte(AddrPort, 0xAA)
```

5.1.1.5 Change base address

<Enter the Extended Function Mode>

```
WriteByte(AddrPort, 0x87)
```

```
WriteByte(AddrPort, 0x87) // Must write twice to enter Extended mode
```

<Select Logic Device>

```
WriteByte(AddrPort, 0x07)
```

```
WriteByte(dataPort, 0x06) // Select logic device 06h
```

```
WriteByte(AddrPort, 0x60) // Select configuration register 60h (High Byte address)
```

```
WriteByte(DataPort, (0x0A))
```

```
WriteByte(AddrPort, 0x61) // Select configuration register 61h (Low Byte address)
```

```
WriteByte(DataPort, (0x00))
```

<Leave the Extended Function Mode>

```
WriteByte(AddrPort, 0xAA)
```

Cincoze default GPIO Port base address is 0xA00h

5.1.1.6 DATA Bit Table (DIO)

7	6	5	4	3	2	1	0	bit
0	0	0	0	0	0	0	1	Value
1								/h

= DI1

7	6	5	4	3	2	1	0	bit
0	0	0	0	0	0	0	1	Value
1								/h

= DO1

7	6	5	4	3	2	1	0	bit
0	0	0	0	0	0	1	0	Value
2								/h

= DI2

7	6	5	4	3	2	1	0	bit
0	0	0	0	0	0	1	0	Value
2								/h

= DO2

7	6	5	4	3	2	1	0	bit
0	0	0	0	0	1	0	0	Value
4								/h

= DI3

7	6	5	4	3	2	1	0	bit
0	0	0	0	0	1	0	0	Value
4								/h

= DO3

7	6	5	4	3	2	1	0	bit
0	0	0	0	1	0	0	0	Value
8								/h

= DI4

7	6	5	4	3	2	1	0	bit
0	0	0	0	1	0	0	0	Value
8								/h

= DO4

7	6	5	4	3	2	1	0	bit
0	0	0	1	0	0	0	0	Value
10								/h

= DI5

7	6	5	4	3	2	1	0	bit
0	0	0	1	0	0	0	0	Value
10								/h

= DO5

7	6	5	4	3	2	1	0	bit
0	0	1	0	0	0	0	0	Value
20								/h

= DI6

7	6	5	4	3	2	1	0	bit
0	0	1	0	0	0	0	0	Value
20								/h

= DO6

7	6	5	4	3	2	1	0	bit
0	1	0	0	0	0	0	0	Value
40								/h

= DI7

7	6	5	4	3	2	1	0	bit
0	1	0	0	0	0	0	0	Value
40								/h

= DO7

7	6	5	4	3	2	1	0	bit
1	0	0	0	0	0	0	0	Value
80								/h

= DI8

7	6	5	4	3	2	1	0	bit
1	0	0	0	0	0	0	0	Value
80								/h

= DO8

5.1.1.7 DIO I/O Port Address (Default Address 0xA00)

DI8	DI7	DI6	DI5	DI4	DI3	DI2	DI1	DO8	DO7	DO6	DO5	DO4	DO3	DO2	DO1	Pin Definition
7	6	5	4	3	2	1	0	7	6	5	4	3	2	1	0	Data Bits
DI								DO								DIO
0xA03								0xA02								I/O Port address

5.2 GM-1000 DIO Hardware Specification

- XCOM+: Isolated power in V+
- XCOM-: Isolated power in V-
- Isolated power in DC voltage: 9-30V
- 8x Digital Input (Source Type)
- Input Signal Voltage Level
 - Signal Logic 0: XCOM+ = 9V, Signal Low - V- < 1V
XCOM+ > 9V, V+ - Signal Low > 8V
 - Signal Logic 1: > XCOM+ - 3V
- Input Driving Sink Current:
 - Minimal: 1 mA
 - Normal: 5 mA
- 8x Digital Output (Open Drain)
 - DO Signal have to pull up resistor to XCOM+ for external device, the resistance will affect the pull up current
 - Signal High Level: Pull up resistor to XCOM+
 - Signal Low Level: = XCOM-
 - Sink Current: 1A (Max)

5.2.1 GM-1000 DIO Connector Definition

DIO1/DIO2: Digital Input / Output Connector

Connector Type: Terminal Block 2X10 10-pin, 3.5mm pitch

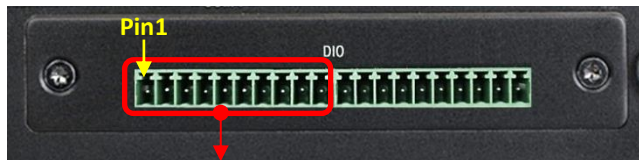

DIO1 (Digital Input)

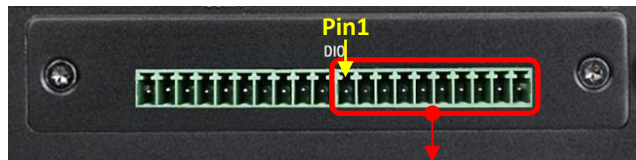

DIO2 (Digital Output)

Location	Pin	Definition
DIO1	1	DC INPUT (XCOM+)
	2	DI1
	3	DI2
	4	DI3
	5	DI4
	6	DI5
	7	DI6
	8	DI7
	9	DI8
	10	GND (XCOM-)

Location	Pin	Definition
DIO2	1	DC INPUT (XCOM+)
	2	DO1
	3	DO2
	4	DO3
	5	DO4
	6	DO5
	7	DO6
	8	DO7
	9	DO8
	10	GND (XCOM-)

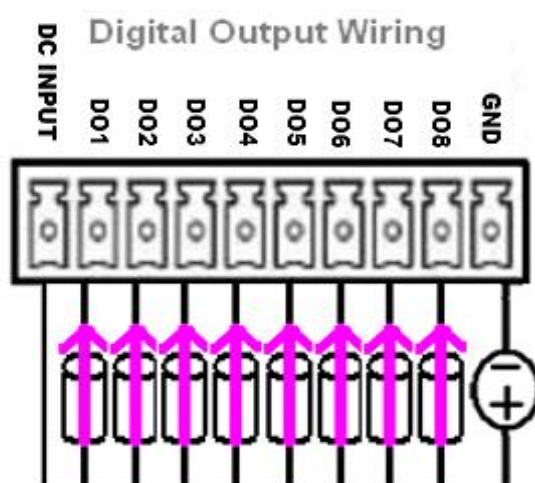
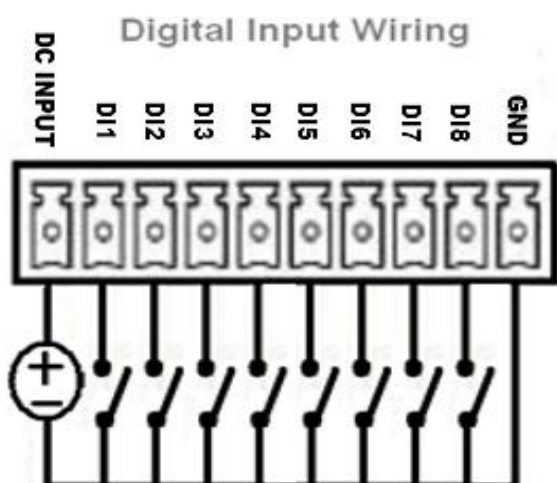

Reference Input Circuit

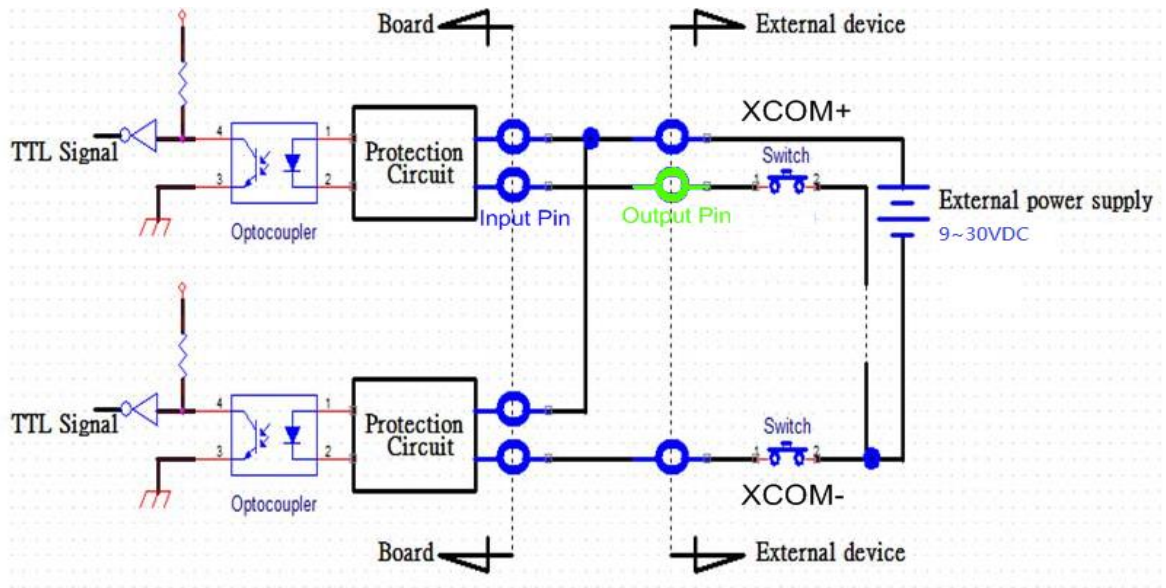

Reference Output Circuit

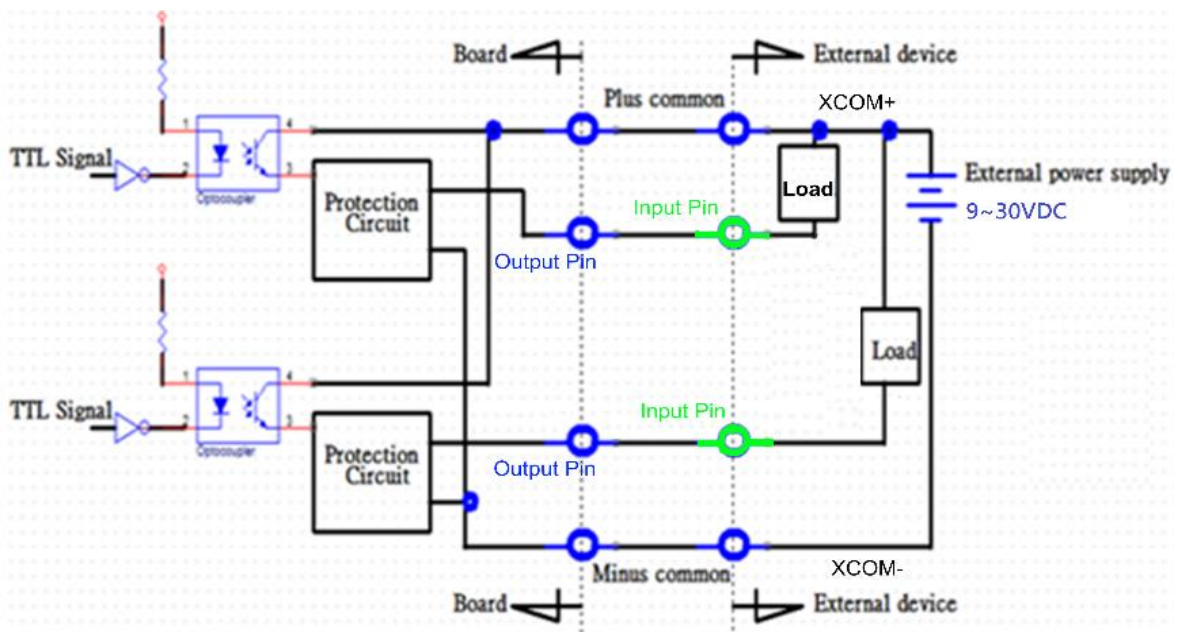



Chapter 6

Optional Modules & Accessories

Pin Definitions and Settings

6.1 CMI-M12 Module Pin Definition & Settings

CMI-M12LAN01 Module Pin Definitions

Connector Type: M12 A coded 8pin connector

Pin	Definition	Pin	Definition
1	2_LAN1_0+	2	2_LAN1_0-
3	2_LAN1_1+	4	2_LAN1_2+
5	2_LAN1_2-	6	2_LAN1_1-
7	2_LAN1_3+	8	2_LAN1_3-

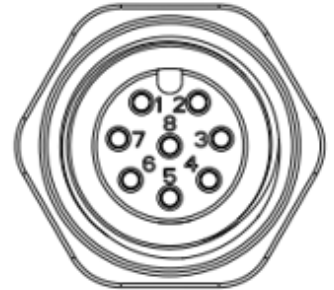

CMI-XM12LAN01 Module Pin Definitions

Connector Type: M12 X coded 8pin connector

Pin	Definition	Pin	Definition
1	D1+	2	D1-
3	D2+	4	D2-
5	D4+	6	D4-
7	D3-	8	D3+

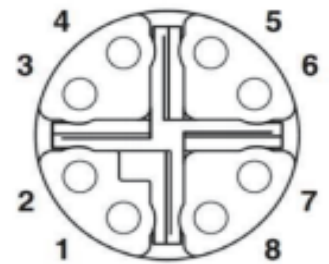

6.2 CMI-COM Module Pin Definition & Settings

Model No.	Product Description
CMI-COM01/UB1303	CMI Module with 2x RS232/422/485 (Support 5V/12V) / 1x Universal Bracket with 2x DB9 Cutout for DX & GM Series

COM5 / COM6: RS232 / RS422 / RS485 Connector

Connector Type: 9-pin D-Sub

Pin	RS232 Definition	RS422 / 485 Full Duplex Definition	RS485 Half Duplex Definition
1	DCD	TX-	DATA -
2	RXD	TX+	DATA +
3	TXD	RX+	
4	DTR	RX-	
5	GND		
6	DSR		
7	RTS		
8	CTS		
9	RI		



SW2 on CMI-COM Module: COM5/COM6 Power Select

Location	Function	DIP1	DIP2
SW2	COM5	0V(RI)	ON (Default)
		5V	ON
		12V	OFF

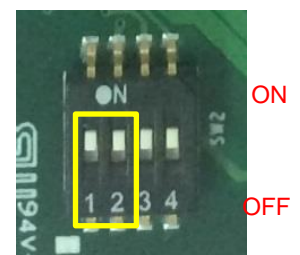

Location	Function	DIP3	DIP4
SW2	COM6	0V(RI)	ON (Default)
		5V	ON
		12V	OFF

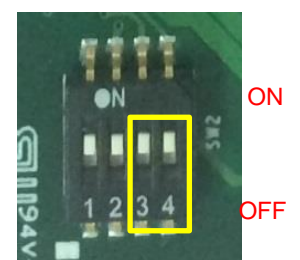

6.3 CFM-IGN Module Pin Definition & Settings

Model No.	Product Description
CFM-IGN01	CFM Module with Power Ignition Sensing Control Function, 12V/24V Selectable

SW2 on CFM-IGN01: IGN Module Timing Setting Switch

Set shutdown delay timer when ACC is turned off

Pin 1	Pin 2	Pin 3	Pin 4	Definition
ON (IGN Enabled) / OFF (IGN Disabled)	ON	ON	ON	0 second
	ON	ON	OFF	1 minute
	ON	OFF	ON	5 minutes
	ON	OFF	OFF	10 minutes
	OFF	ON	ON	30 minutes
	OFF	ON	OFF	1 hour
	OFF	OFF	ON	2 hours
	OFF	OFF	OFF	Reserved (0 second)

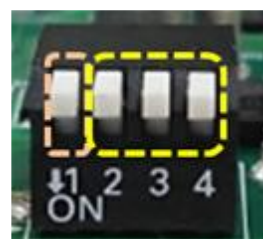

OFF
ON

Default setting of Pin1 to Pin4 is OFF/OFF/OFF/OFF.

24V_12V_1: IGN Module Voltage Mode Setting Switch

12V / 24V Car Battery Switch

Pin	Definition
1-2	12V Car Battery Input (Default)
2-3	24V Car Battery Input

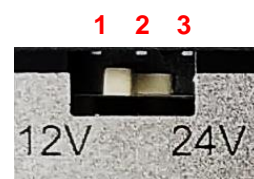

6.4 Install an MXM Module

1. Locate the connector of MXM carrier board (J1) on the top side of system.

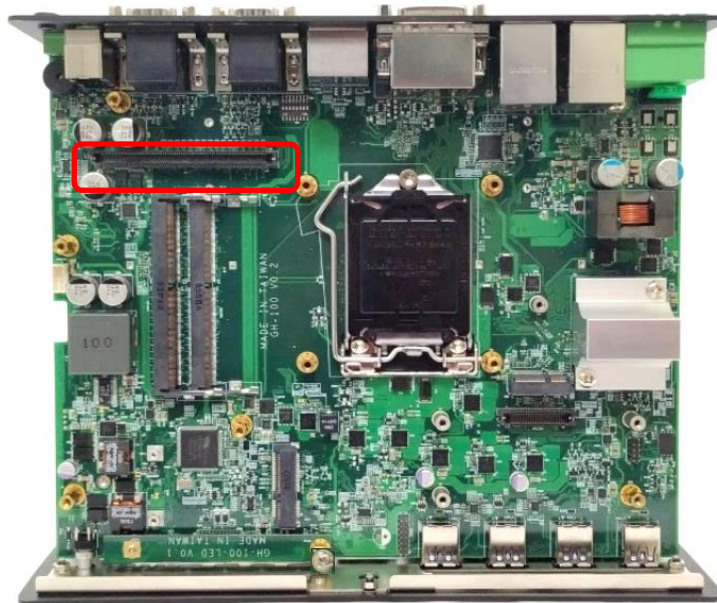

2. Insert the MXM carrier board vertically to the connector on the system mainboard.

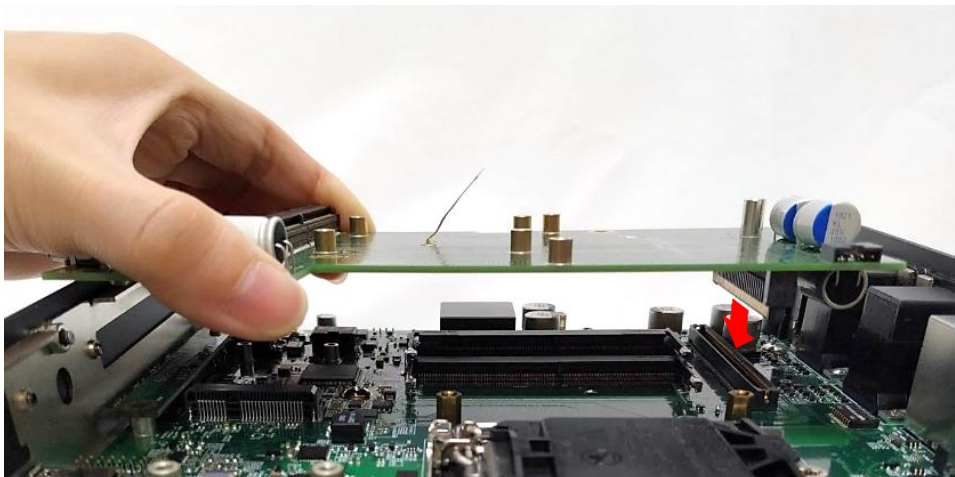

3. Insert the MXM carrier board vertically to the connector on the system mainboard, and fasten the screws as indicated below.

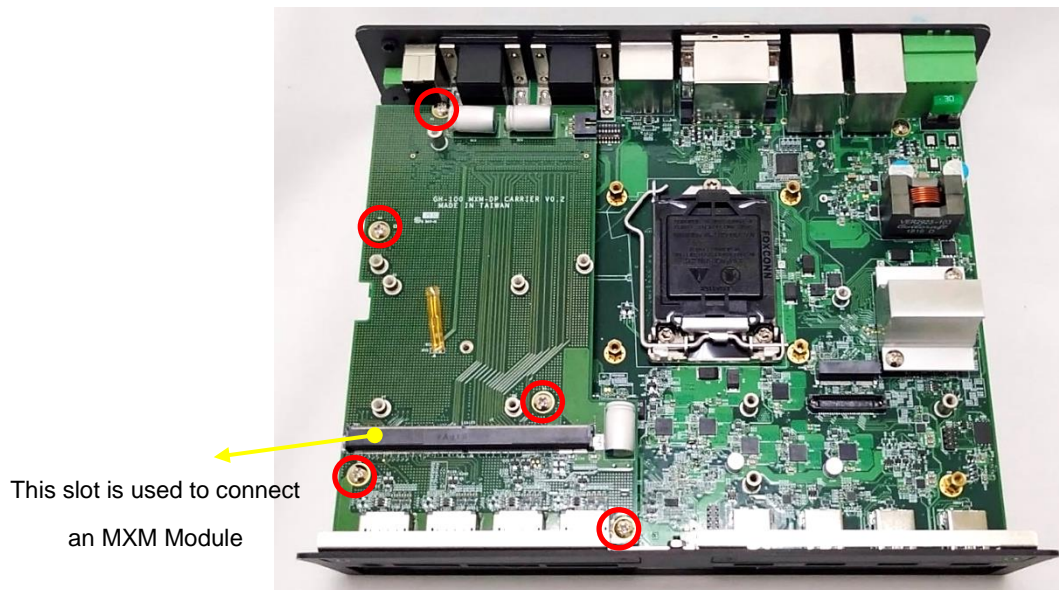

4. Place the thermal pad on the chip of MXM Module.

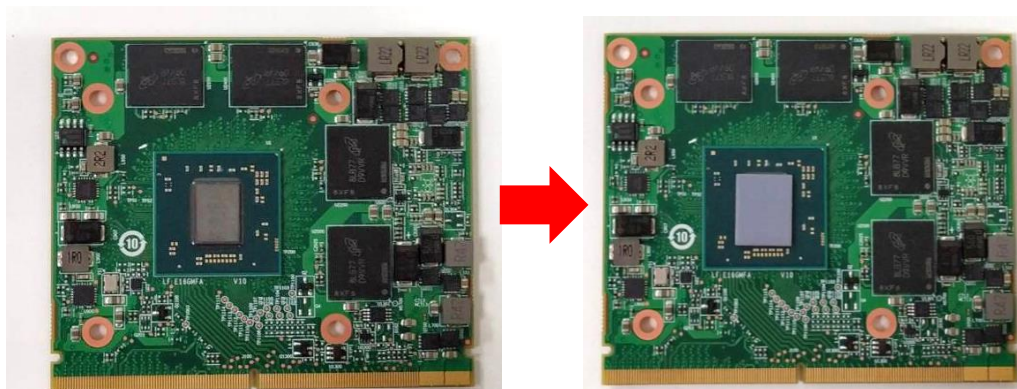

5. Insert the MXM Module into the slot on the MXM carrier board at 45 degrees.

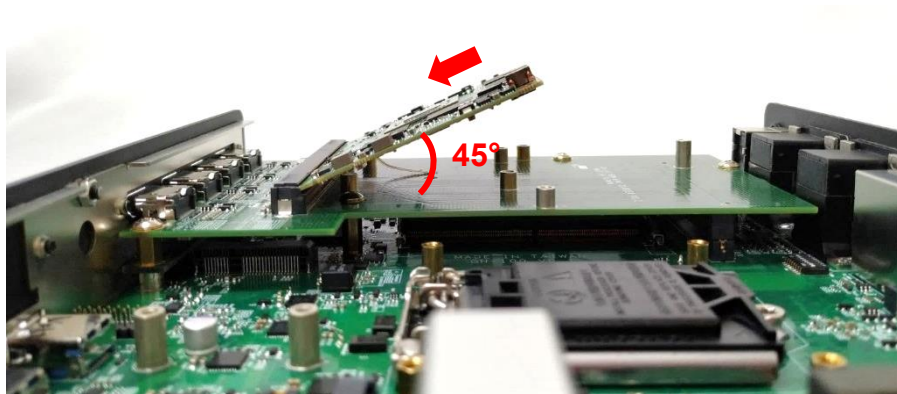

6. Fasten the two screws (M3X5L).

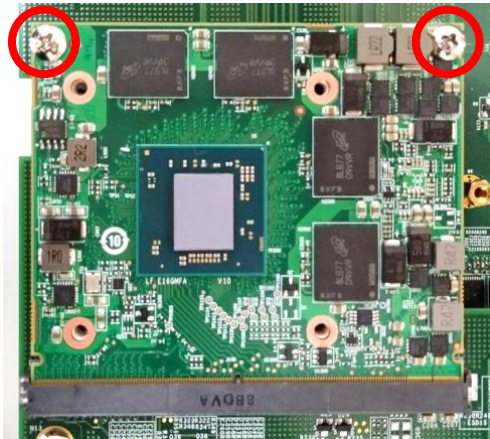

CAUTION

Before putting on the thermal block (in the next step), please make sure the protective film on the Thermal Pad has been removed!

7. Put on the thermal block with aligning the screw-holes, and fasten the 4 screws (M3X8L).

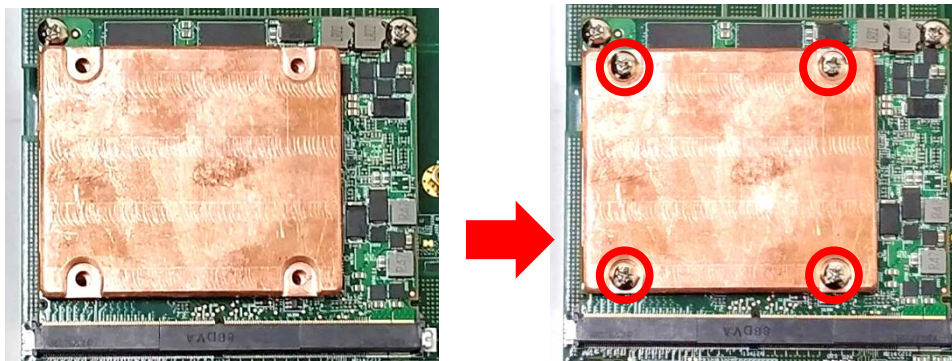

8. Place the thermal pad on the thermal block.

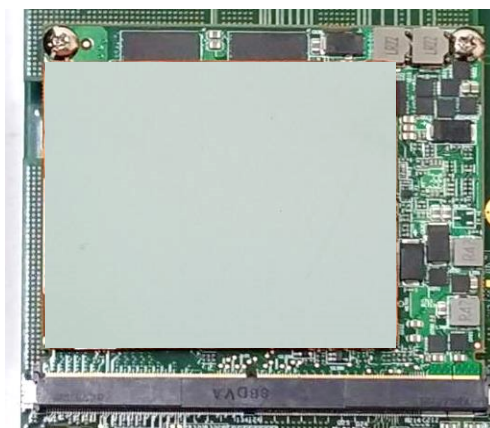

CAUTION

Before assembling the system's chassis cover, please make sure the protective film on the Thermal Pad has been removed!

9. Replace the cover plate at front panel by the accompanying bracket with 4x DP cutout.

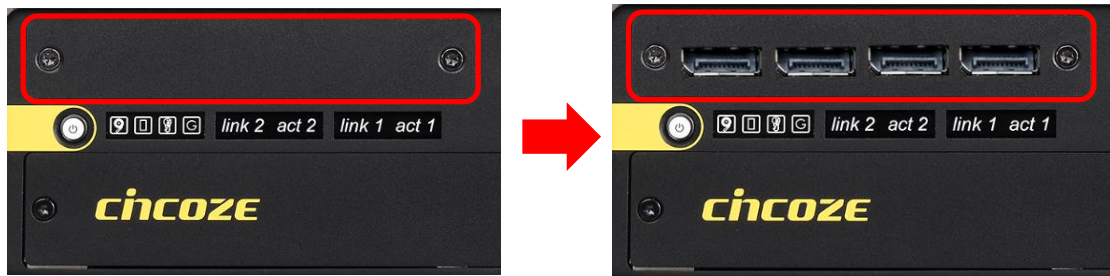

6.5 Install a High Speed CMI Module

The applicable high speed CMI modules for GM-1000 series are CMI-LAN01-R12/UB1312, CMI-10GLAN01/UB1328, CMI-M12LAN01-R12/UB1310, CMI-XM12LAN01/ UB1330.

6.5.1 CMI-M12LAN01-R12/UB1310 module

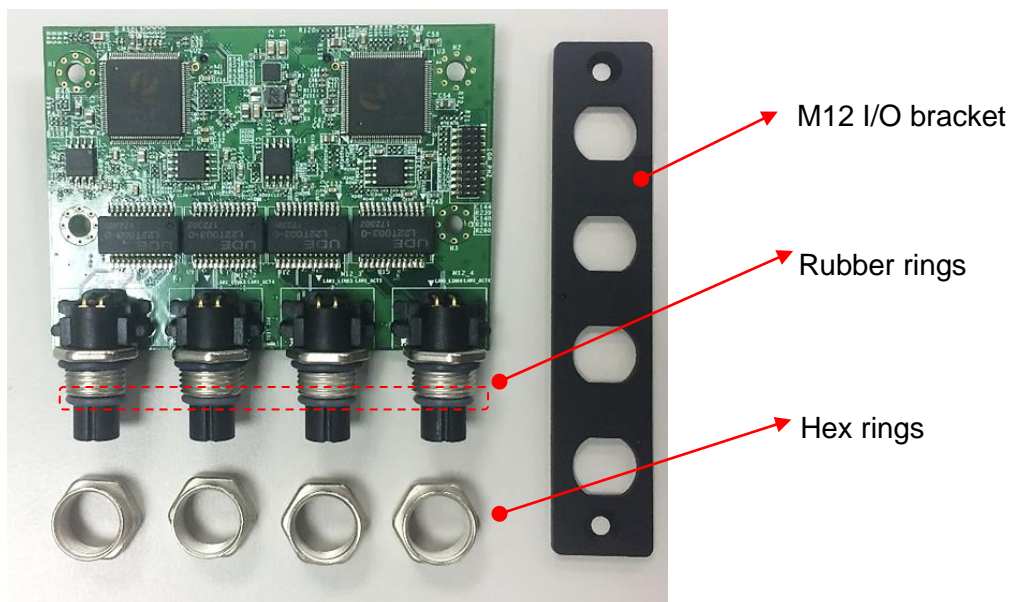

1. Loosen the 2 screws on the front panel to remove the cover plate.



2. Locate the connector of CMI-module (BTB_FH4) on the top side of system.

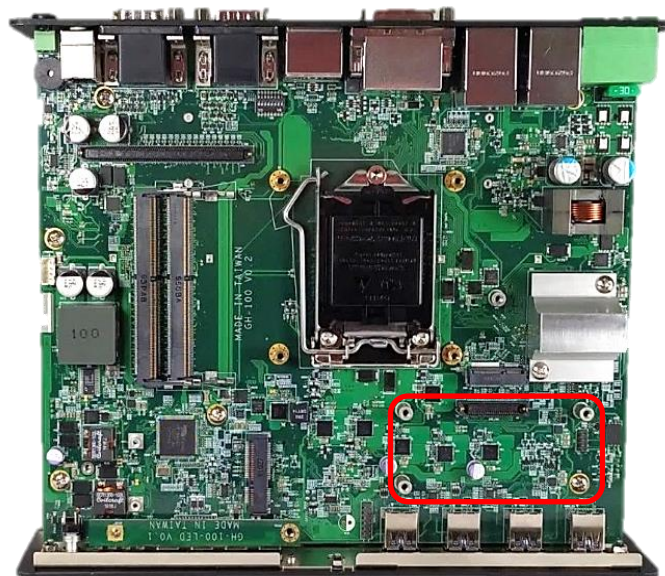

3. Replace the screw by a copper pillar before inserting the CMI module.



4. Insert the CMI module vertically to the female connector on the system mainboard.



5. Fasten the 4 screws to fix it.

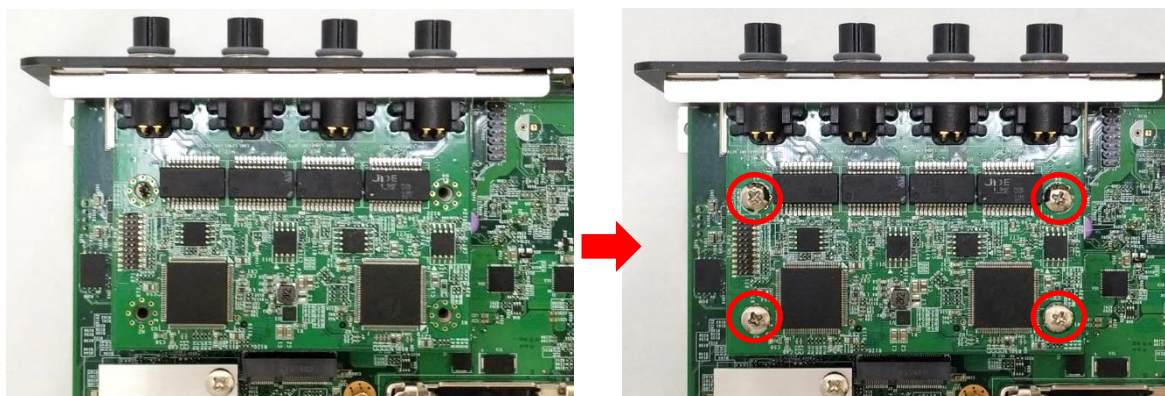

6. Attach the M12 I/O bracket, and fasten the two screws and four hex rings to fix it.

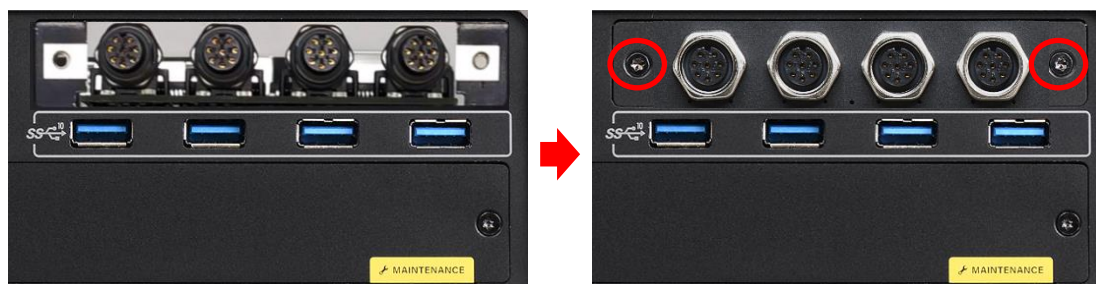

6.5.2 CMI-XM12LAN01/UB1330 module

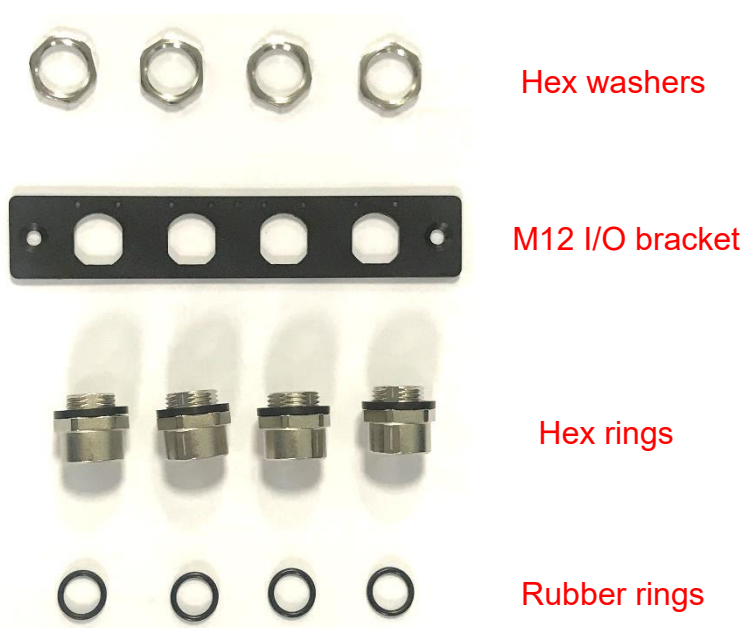

1. Assemble the hex rings, M12 I/O bracket and hex washers together as indicated below:
Penetrate hex rings through the M12 I/O bracket holes, and fix them with hex washers.



2. Loosen the 2 screws on the front panel to remove the cover plate.



3. Locate the connector of CMI-module (BTB_FH4) on the top side of system.

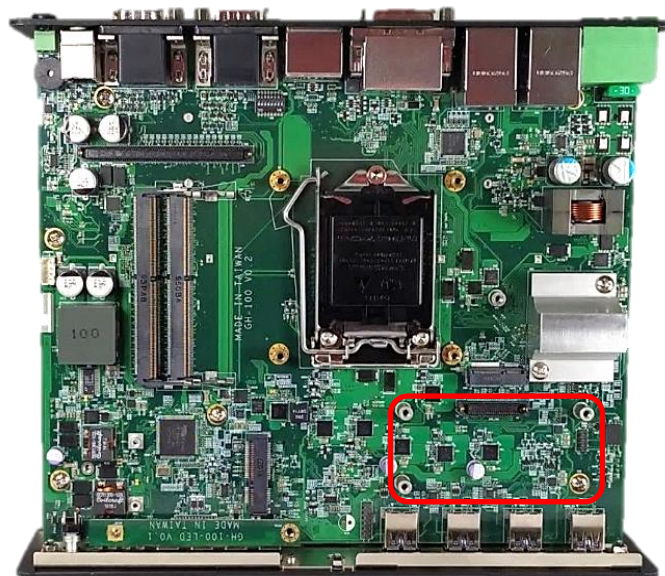

4. Replace the screw by a copper pillar before inserting the CMI module.



5. Insert the CMI module vertically to the female connector on the system mainboard.



6. Fasten the 4 screws to fix it.

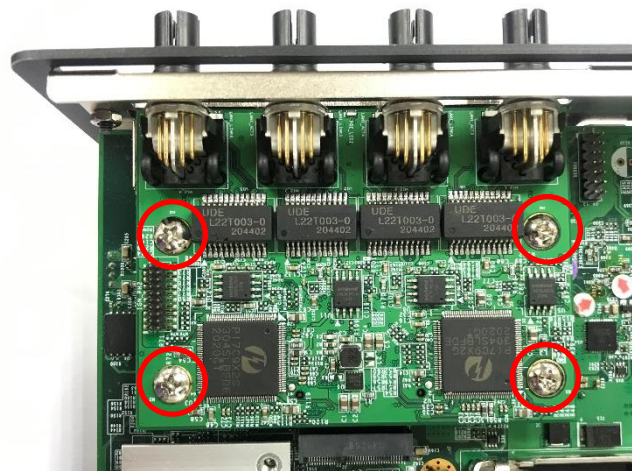

7. Attach the assembled M12 I/O bracket on to the system, and fasten the two screws to fix it.

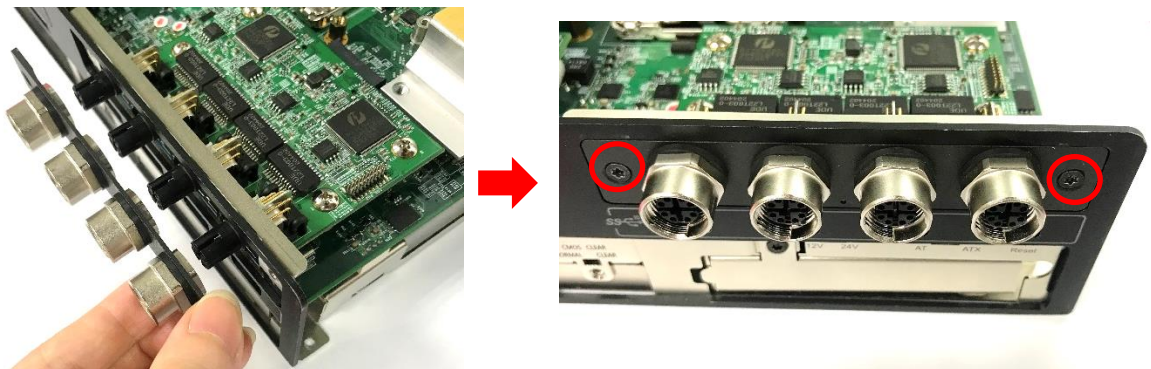

8. Put on the rubber rings to the four M12 LAN ports.

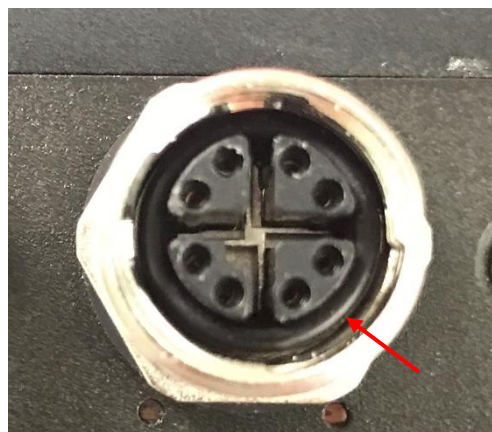

6.5.3 CMI-10GLAN01/UB1328 module

Before installing CMI-10GLAN01/UB1328 module, users need to enter BIOS to complete the following setting first. When entering BIOS, get to Chipset > PCH-IO Configuration page, and change the [BTB_FH4 Mode Selection] setting from default mode [4x1] to mode [1x4].

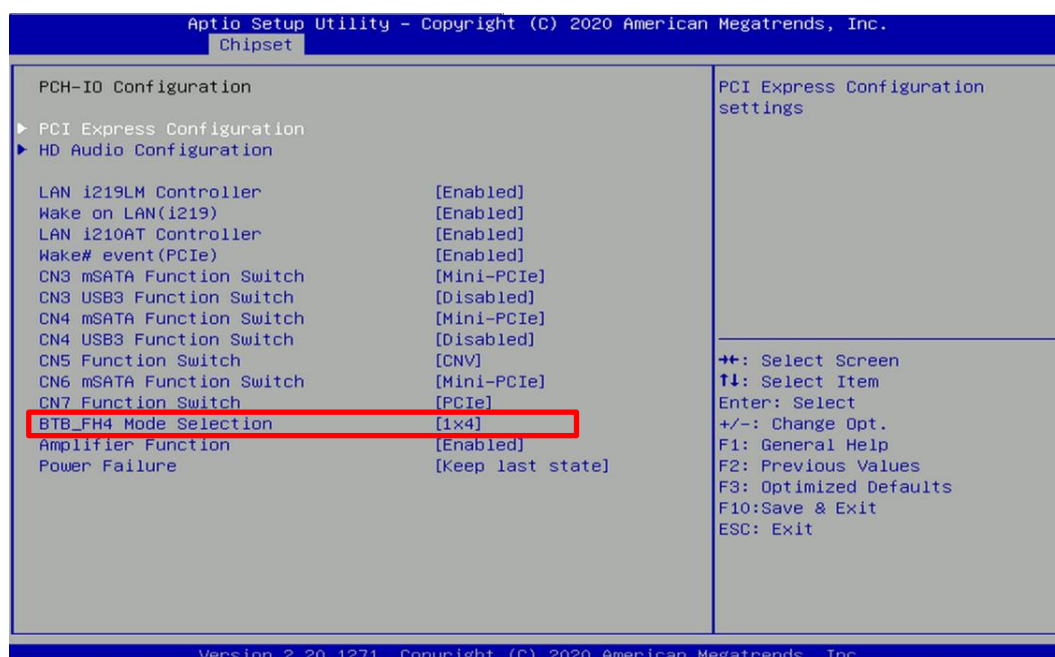

1. Loosen the 2 screws on the front panel to remove the cover plate.



2. Locate the connector of CMI-module (BTB_FH4) on the top side of system.

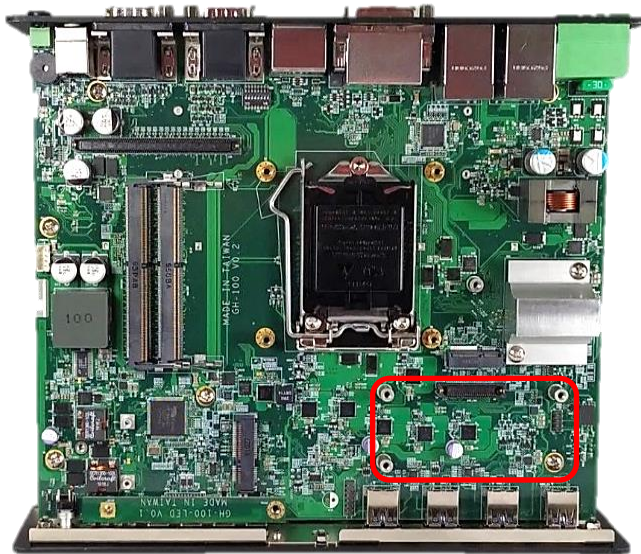

3. Replace the screw by copper pillar before insert the CMI module.

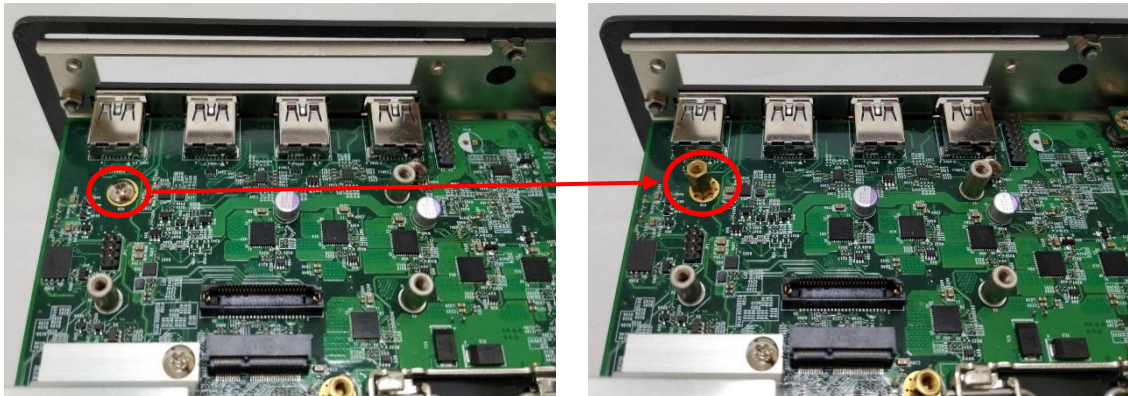

4. Locate the chip place on the CMI-10GLAN01 module marked by red square. Paste the thermal pad on it carefully.

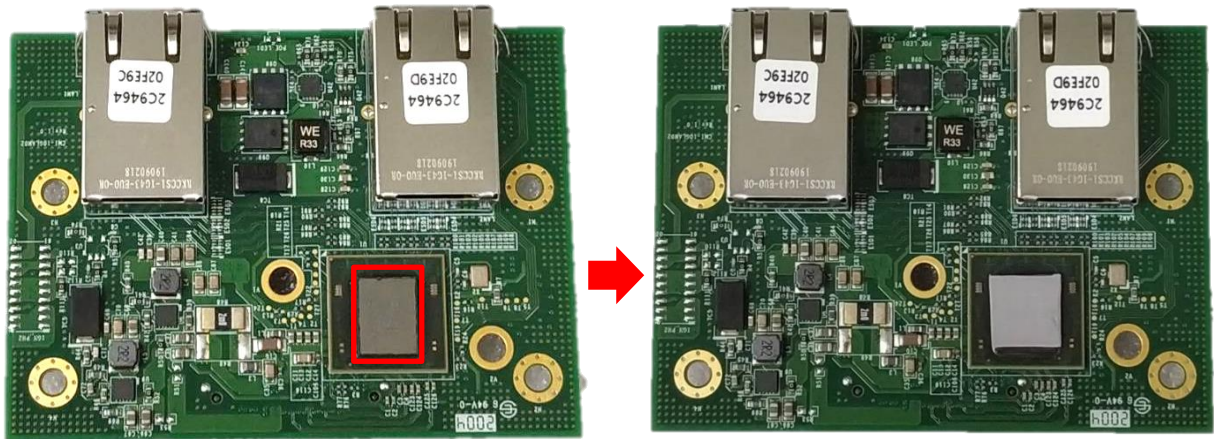

CAUTION

Before putting on the thermal block (in the next step), please make sure the protective film on the Thermal Pad has been removed!

5. Put on the heatsink and turn over the module. Fasten the screw to fix the heatsink.

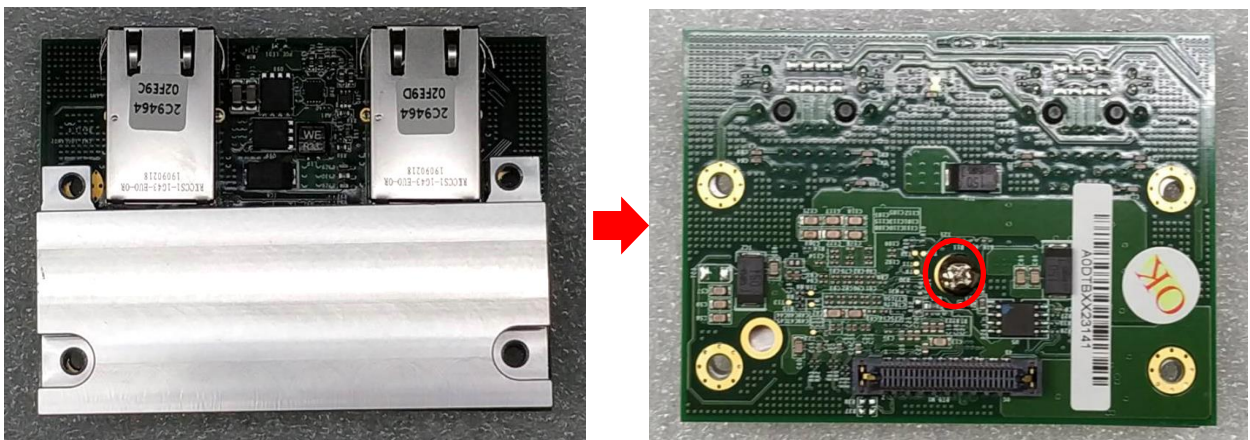

6. Insert the CMI module vertically to the female connector on the system mainboard.



7. Fasten the 4 screws to fix it.

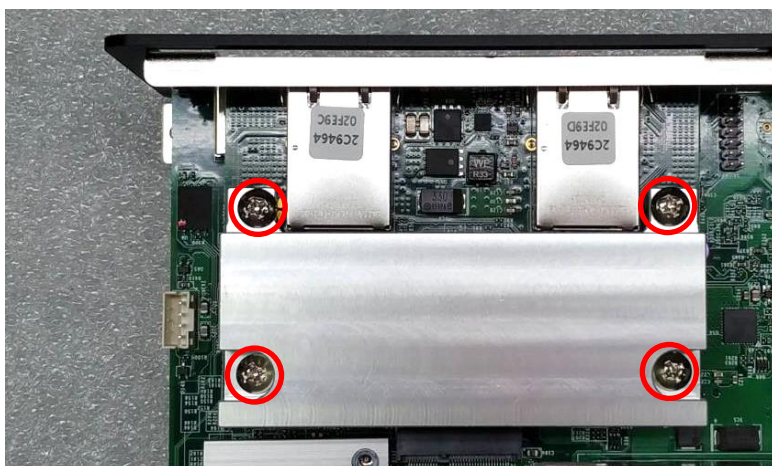

8. Paste the last thermal pad onto the heatsink carefully.

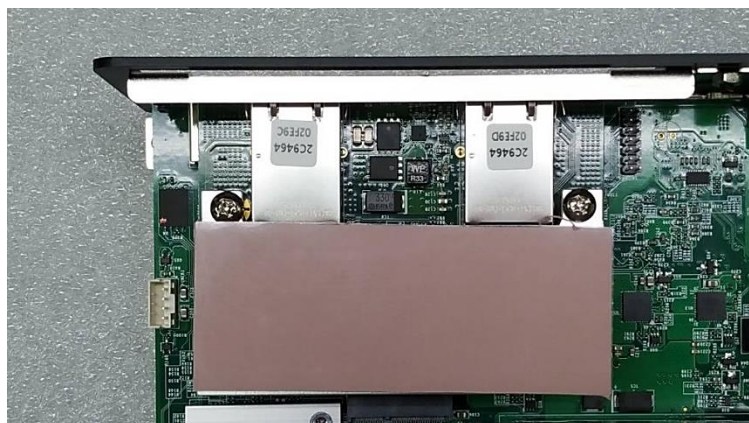

CAUTION

Before assembling the system's chassis cover, please make sure the protective film on the Thermal Pad has been removed!

9. Attach the I/O bracket, and fasten the two screws to fix it.

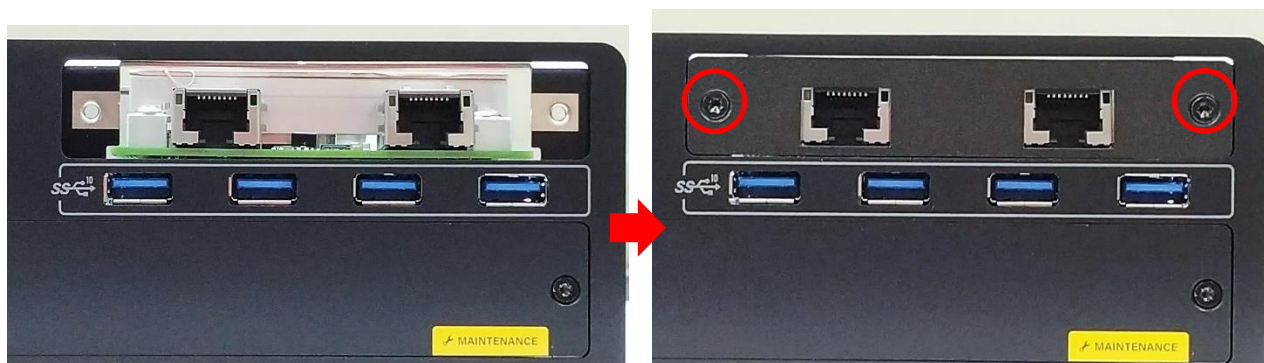

6.6 Install a CFM-PoE Module

The CFM-PoE module for GM-1000 series is installed on the CMI-LAN01-R12/UB1312, the CMI-M12LAN01/UB1310 or the CMI-XM12LAN01/UB1330 module.

The photo example in this section is illustrated by CMI-M12LAN01-R12/UB1310/CFM-PoE01 module. If you use CMI-LAN module, please paste the shading tape to the place which was marked by red circle. If you use the other modules please skip this step. (Note: Do not make the tape block the LED.)

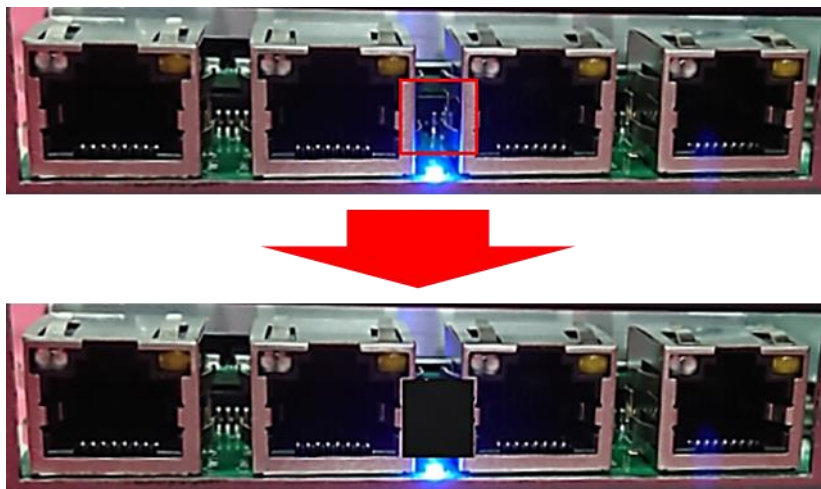

1. Please execute the installing step1 to step4 in chapter 6.5.1 in advance, and fasten 4 copper pillars to fix it.

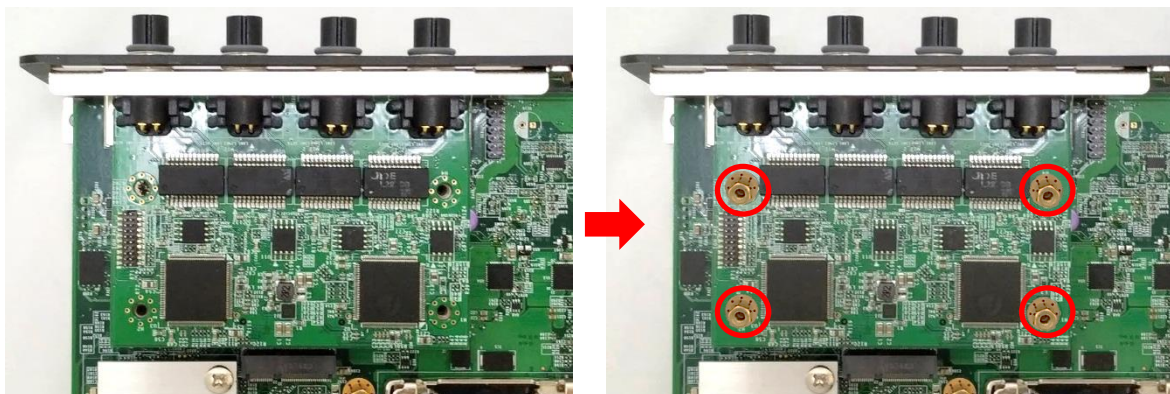

2. Insert the CFM-PoE01 module vertically into the male connector of the CMI module until it's connected firmly.



3. Turn over the heatsink of CFM-PoE01 and locate the two places marked by red squares. Paste the two thermal pads for CFM-PoE01 onto the heatsink carefully.

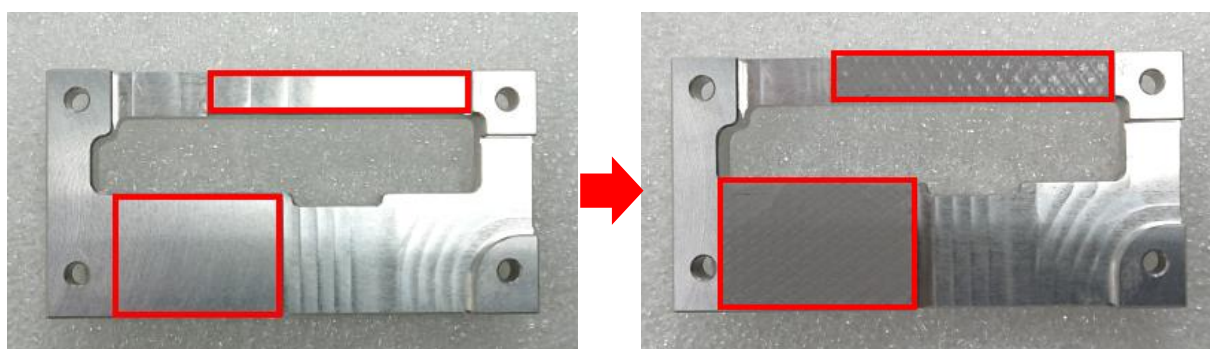

CAUTION

Before putting on the thermal block (in the next step), please make sure the protective films on the Thermal Pads have been removed!

4. Paste the heatsink onto the CMI-PoE module carefully and connect the PoE module to the CMI-M12LAN module.



5. Fasten 4 screws to fix it.

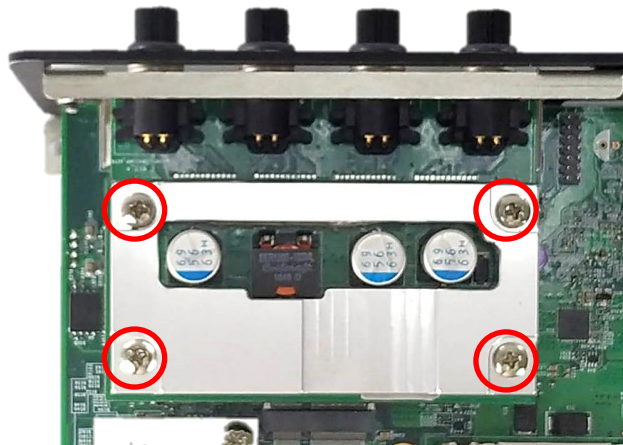

6. Paste the last thermal pad onto the heatsink carefully, and then execute the step 6 in chapter 6.5.1 to complete the installation.



CAUTION

The yellow surface is part of the thermal pad. Do not tear it off as it would affect the thermal conductivity.

6.7 Install a CMI-DIO Module

1. Locate the connector of CMI-module (BTB_FH1) on the bottom side of system.

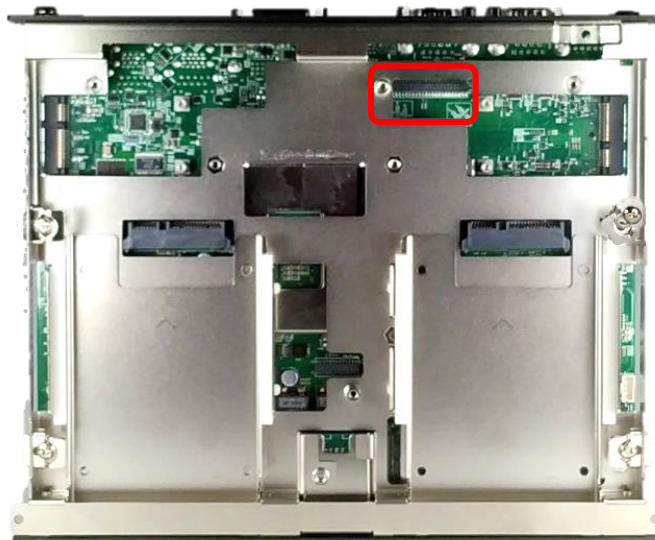

2. Loosen the 2 screws on rear panel to remove the cover plate

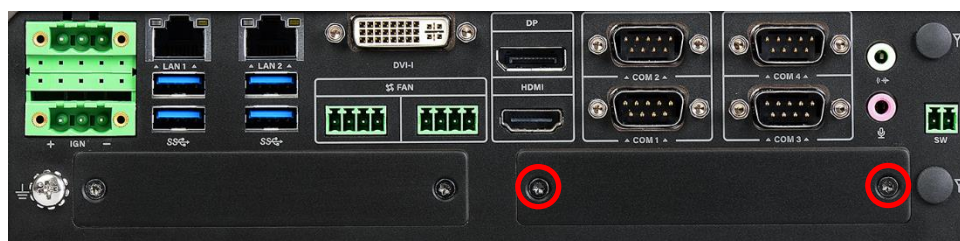

3. Penetrate the CMI-DIO module through the area with an inclined angle.

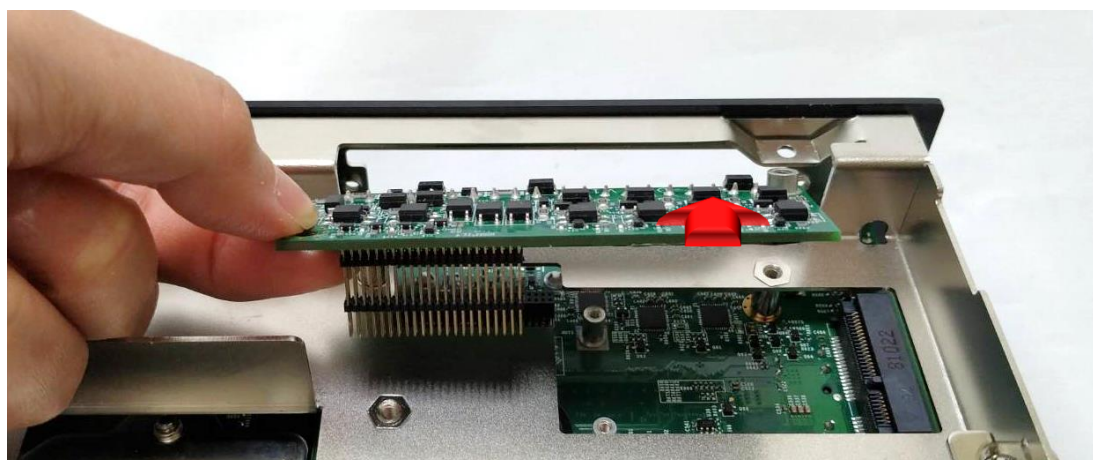

4. Insert the CMI-DIO module carefully to the CMI connector on main board. Fix it with the two screws as indicated.

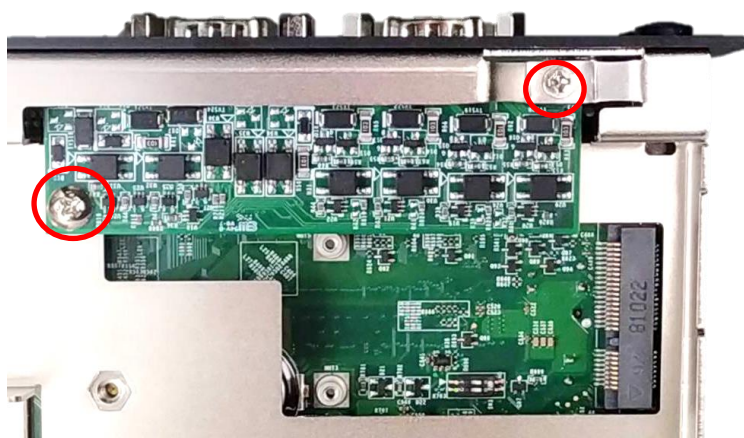

5. Attach the CMI-DIO bracket, and fasten the two screws to fix it.

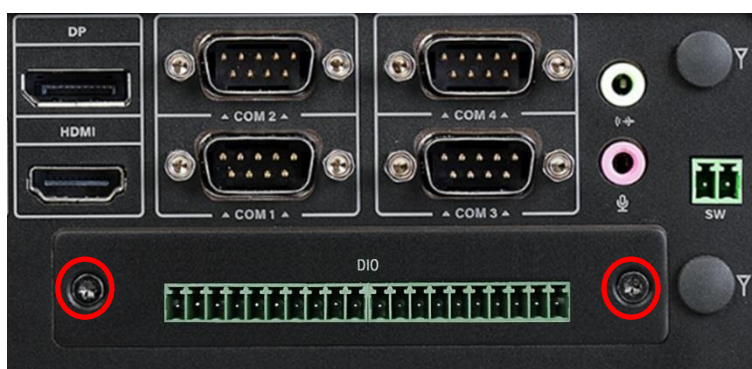

6.8 Install a CMI-COM Module

1. Locate the connector of CMI-module (BTB_FH1) on the bottom side of system.

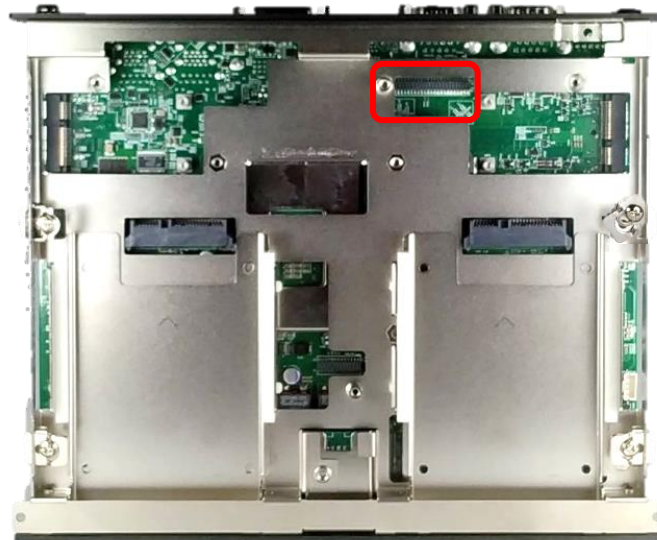

2. Loosen the 2 screws on rear panel to remove the cover plate

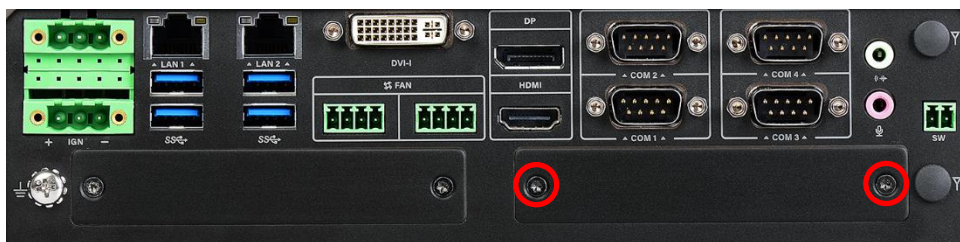

3. Penetrate the CMI-COM module through the area with an inclined angle.



4. Insert the CMI-COM module carefully to the CMI connector on main board. Fix it with the two screws as indicated.



5. Loosen the 4 D-Sub jack screws as marked on photo.

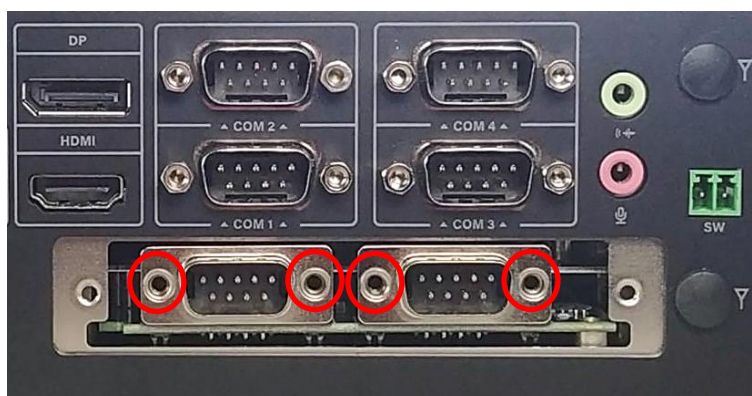

6. Attach the COM bracket. Fasten 2 screws and 4 D-Sub jack screws to fix it.

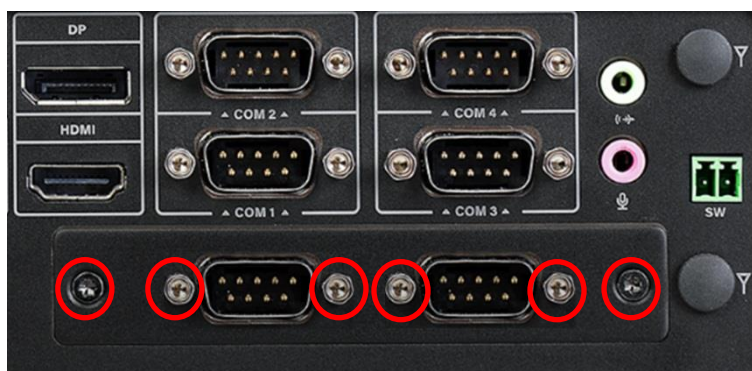

6.9 Install an IGN Module

1. Locate the power Ignition connector (IGN_PH1) on system motherboard as indicated.

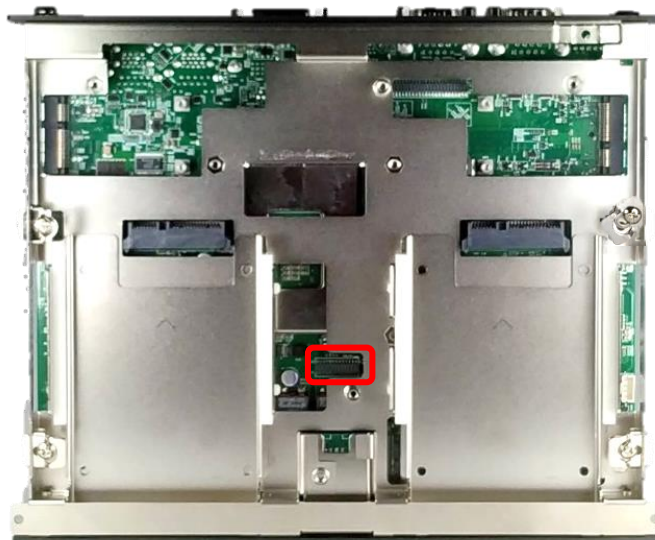

2. Insert the connector of power ignition board to the female connector on system motherboard.



3. Fasten two screws to secure the power ignition board.

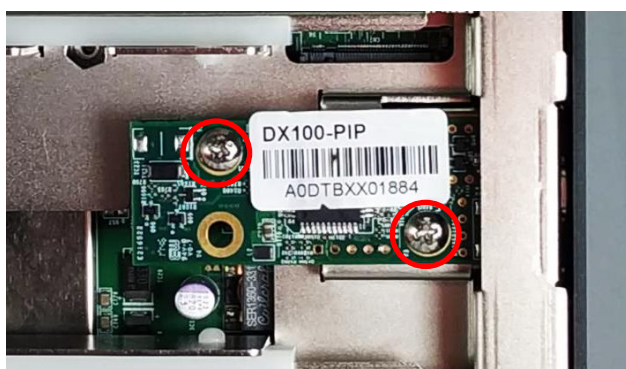

6.10 Install an External Fan

1. Prepare an external fan. Loosen the 2 screws halfway on mounting frame before attempting to install it.

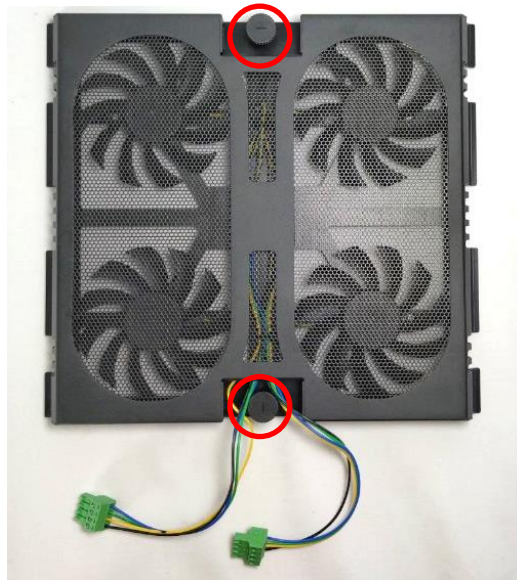

2. Slide the FAN into the groove of chassis as illustrated.



3. Tighten the 2 screws to fix it onto chassis.

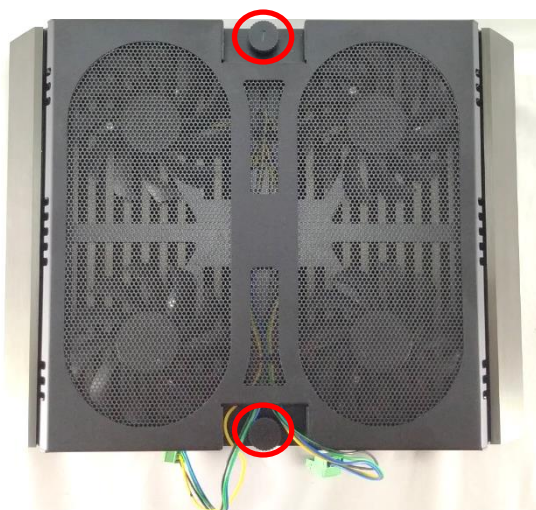

4. Insert the plug of the external fan to the external fan power connector.

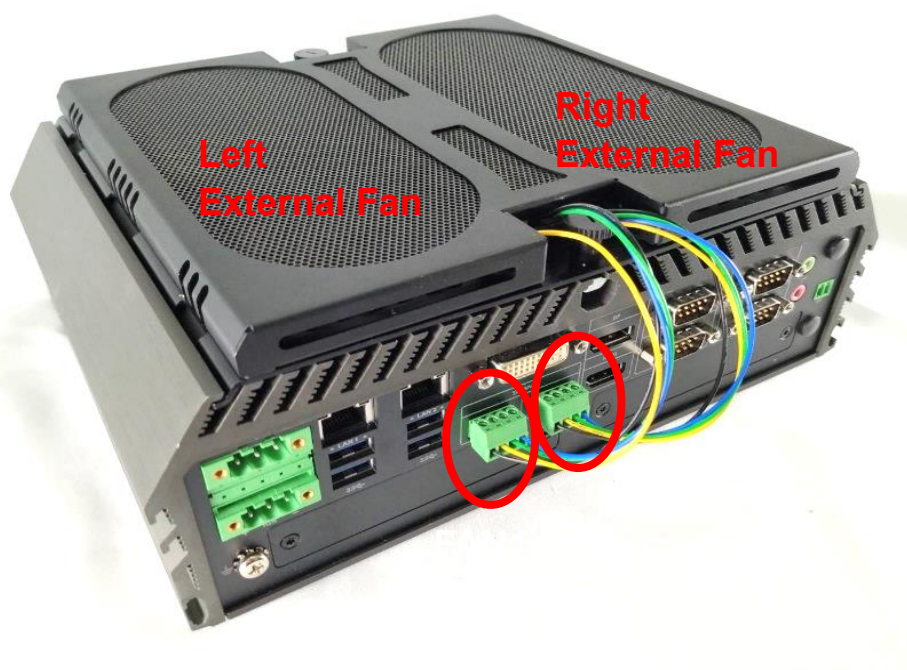

NOTE

Make sure that the plug of the left external fan is connected to the FAN1 : CPU smart FAN connector , and the plug of the right external fan is connected to the FAN2 : GPU (MXM) smart FAN connector.

6.11 DIN-Rail Mount Brackets

GM-1000 series offers DIN-Rail Mount that customer can install system on the DIN Rail.

1. Please refer to section 3.14 Wall Mount Brackets to install mounting bracket at both sides of system. Fasten 2 DIN rail mounting clips to mounting brackets on both sides with provided 4 screws as illustrated.



2. Clip the system into DIN rail as illustrated by the following steps. (1) Have lower end of mounting clip snaps into the DIN rail. (2) Press the system toward to have upper end of mounting clip snaps into the other side of DIN rail.



6.12 Side Mount Bracket

GM-1000 series offers Side Mount Bracket that customer can install system to the right or left side of wall to create effective of space.



1. The mounting holes are at the bottom side of system. Fasten the 8 screws to fix the side mount bracket with system together.

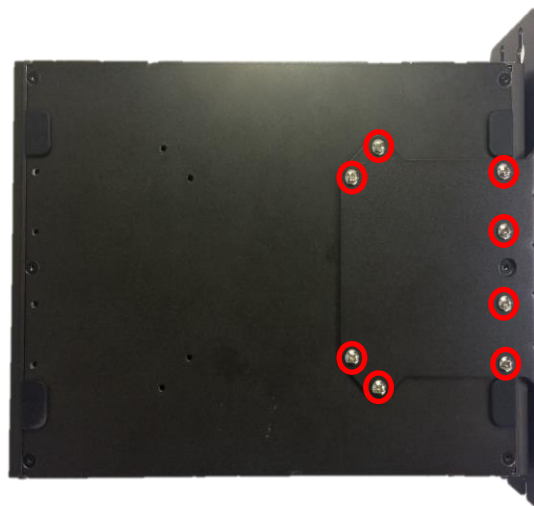

2. Fasten the screws through the bracket mounting hole to mount system on the wall.



cincoze

© 2020 Cincoze Co., Ltd. All rights reserved.

The Cincoze logo is a registered trademark of Cincoze Co., Ltd.

All other logos appearing in this catalog are the intellectual property of the respective company, product, or organization associated with the logo.

All product specifications and information are subject to change without notice.