

cicoze

DX-1200

User Manual



Rugged Embedded Computer

13/12th Gen. Intel® Core Series High Performance and Compact
Rugged Embedded Computer

Contents

Preface	5
Revision	5
Copyright Notice	5
Acknowledgement	5
Disclaimer.....	5
Declaration of Conformity.....	6
Product Warranty Statement	6
Technical Support and Assistance	7
Conventions Used in this Manual	8
Safety Precautions.....	8
Package Contents	9
Ordering Information	10
Chapter 1 Product Introductions	11
1.1 Overview	12
1.2 Highlights.....	12
1.3 Product Pictures.....	13
1.4 Key Features.....	13
1.5 Hardware Specification	14
1.6 System I/O.....	18
1.6.1 Front.....	18
1.6.2 Rear	19
1.7 Mechanical Dimension.....	20
Chapter 2 Switches & Connectors.....	21
2.1 Location of Switches and Connectors	22
2.1.1 Top View.....	22
2.1.2 Bottom View	23
2.2 Switches and Connectors Definition	24
2.3 Definition of Switches	25
2.4 Definition of Connectors	27
Chapter 3 System Setup.....	33
3.1 Removing Top Cover.....	34
3.2 Installing CPU	36
3.3 Installing SO-DIMM Memory	40
3.4 Installing Mini-PCIe/mSATA Card	41
3.5 Installing M.2 E Key Card.....	42
3.6 Installing Antenna(s)	43
3.6.1 For Antenna 1 or 2	43
3.6.2 For Antenna 3.....	45
3.7 Installing Top Cover	47

3.8 Installing Bottom Cover	48
3.9 Removing Maintenance Cover	49
3.10 Installing SATA HDD/SSD	49
3.11 Installing SIM Card	51
3.12 Replacing CMOS Battery	52
3.13 Installing Maintenance Cover	53
3.14 Installing Wall Mount	54
3.15 Installing VESA Mount	55
Chapter 4 BIOS Setup	56
4.1 BIOS Introduction	57
4.2 Main Setup	58
4.3 Advanced Setup	59
4.3.1 CPU Configuration	59
4.3.2 Power & Performance	60
4.3.3 SATA And RST Configuration	61
4.3.4 PCH-FW Configuration	62
4.3.5 Trusted Computing Settings	62
4.3.6 ACPI Settings	63
4.3.7 F81966 Super IO Configuration	64
4.3.8 Hardware Monitor	65
4.3.9 S5 RTC Wake Settings	66
4.3.10 Serial Port Console Redirection	66
4.3.11 USB Configuration	67
4.3.12 Network Stack Configuration	68
4.3.13 CSM Configuration	68
4.4 Chipset Setup	69
4.4.1 System Agent (SA) Configuration	69
4.4.2 PCH-IO Configuration	70
4.5 Security Setup	72
4.6 Boot Setup	73
4.7 Save & Exit	74
4.8 MEBx	75
Chapter 5 Product Application	78
5.1 Digital I/O (DIO) application	79
5.1.1 Digital I/O Programming Guide	79
5.2 DIO Hardware Specification	86
Chapter 6 Optional Modules and Accessories	89
6.1 Pin Definition & Settings	90
6.1.1 CMI-M12LAN01-R12/ UB1710-R10	90
6.1.2 CMI-XM12LAN01-R10/ UB0930-R10	90
6.1.3 CMI-COM01/UB1303	91

6.1.4 CFM-IGN01.....	92
6.2 Installing a High Speed CMI Module	93
6.2.1 CMI-10GLAN05-R10/UB1728-R10	93
6.2.2 CMI-LAN01-R12/UB1712-R10.....	96
6.2.3 CMI-M12LAN01-R12/UB1710-R10	98
6.2.4 CMI-XM12LAN01-R10/UB0930-R10	101
6.3 Installing Low Speed CMI Module.....	104
6.3.1 CMI-COM01/UB1303	104
6.3.2 CMI-DIO01/UB1318	105
6.4 Installing CFM Modules.....	106
6.4.1 CFM-PoE01.....	106
6.4.2 CFM-IGN01.....	110
6.5 Installing MEC Modules.....	111
6.5.1 MEC-COM-M212-TDB9/UB1303.....	111
6.5.2 MEC-COM-M334-TDB9/2xUB1303	113
6.5.3 MEC-LAN-M102-30/UB1311	115
6.6 Installing Optional Accessories	117
6.6.1 SIDE-DX.....	117
6.6.2 DIN01	118
6.6.3 FAN-EX101.....	119

Preface

Revision

Revision	Description	Date
1.00	First Release	2023/05/05
1.01	Correction Made	2023/05/30
1.02	Correction Made	2023/06/30
1.03	Correction Made	2023/07/26
1.04	Correction Made	2023/09/26
1.10	Processor and OS Spec Updated	2024/04/26
1.11	Correction Made	2024/06/03
1.12	E-mark Certification Obtained	2024/07/08

Copyright Notice

© 2023 by Cincoze Co., Ltd. All rights are reserved. No parts of this manual may be copied, modified, or reproduced in any form or by any means for commercial use without the prior written permission of Cincoze Co., Ltd. All information and specification provided in this manual are for reference only and remain subject to change without prior notice.

Acknowledgement

Cincoze is a registered trademark of Cincoze Co., Ltd. All registered trademarks and product names mentioned herein are used for identification purposes only and may be trademarks and/or registered trademarks of their respective owners.

Disclaimer

This manual is intended to be used as a practical and informative guide only and is subject to change without notice. It does not represent a commitment on the part of Cincoze. This product might include unintentional technical or typographical errors. Changes are periodically made to the information herein to correct such errors, and these changes are incorporated into new editions of the publication.

Declaration of Conformity



FCC

This equipment has been tested and found to comply with the limits for a Class A digital device, pursuant to Part 15 of the FCC Rules. These limits are designed to provide reasonable protection against harmful interference when the equipment is operated in a commercial environment. This equipment generates, uses, and can radiate radio frequency energy and, if not installed and used in accordance with the instruction manual, may cause harmful interference to radio communications. Operation of this equipment in a residential area is likely to cause harmful interference in which case the user will be required to correct the interference at his own expense.



CE

The product(s) described in this manual complies with all application European Union (CE) directives if it has a CE marking. For computer systems to remain CE compliant, only CE-compliant parts may be used. Maintaining CE compliance also requires proper cable and cabling techniques.



UL

A product that carries the “UL Listed” approval mark means that the product has been tested by UL to nationally recognized Safety Standards and has been found to be free from reasonably foreseeable risk of fire, electric shock and related hazards

Product Warranty Statement

Warranty

Cincoze products are warranted by Cincoze Co., Ltd. to be free from defect in materials and workmanship for 2 years from the date of purchase by the original purchaser. During the warranty period, we shall, at our option, either repair or replace any product that proves to be defective under normal operation. Defects, malfunctions, or failures of the warranted product caused by damage resulting from natural disasters (such as by lightning, flood, earthquake, etc.), environmental and atmospheric disturbances, other external forces such as power line disturbances, plugging the board in under power, or incorrect cabling, and damage caused by misuse, abuse, and unauthorized alteration or repair, and the product in question is either software, or an expendable item (such as a fuse, battery, etc.), are not warranted.

RMA

Before sending your product in, you will need to fill in Cincoze RMA Request Form and obtain an RMA number from us. Our staff is available at any time to provide you with the most friendly and immediate service.

■ RMA Instruction

- Customers must fill in Cincoze Return Merchandise Authorization (RMA) Request Form and obtain an RMA number prior to returning a defective product to Cincoze

for service.

- Customers must collect all the information about the problems encountered and note anything abnormal and describe the problems on the “Cincoze Service Form” for the RMA number apply process.
- Charges may be incurred for certain repairs. Cincoze will charge for repairs to products whose warranty period has expired. Cincoze will also charge for repairs to products if the damage resulted from acts of God, environmental or atmospheric disturbances, or other external forces through misuse, abuse, or unauthorized alteration or repair. If charges will be incurred for a repair, Cincoze lists all charges, and will wait for customer’s approval before performing the repair.
- Customers agree to ensure the product or assume the risk of loss or damage during transit, to prepay shipping charges, and to use the original shipping container or equivalent.
- Customers can be sent back the faulty products with or without accessories (manuals, cable, etc.) and any components from the system. If the components were suspected as part of the problems, please note clearly which components are included. Otherwise, Cincoze is not responsible for the devices/parts.
- Repaired items will be shipped along with a "Repair Report" detailing the findings and actions taken.

Limitation of Liability

Cincoze’ liability arising out of the manufacture, sale, or supplying of the product and its use, whether based on warranty, contract, negligence, product liability, or otherwise, shall not exceed the original selling price of the product. The remedies provided herein are the customer’s sole and exclusive remedies. In no event shall Cincoze be liable for direct, indirect, special or consequential damages whether based on contract of any other legal theory.

Technical Support and Assistance

1. Visit the Cincoze website at www.cincoze.com where you can find the latest information about the product.
2. Contact your distributor or our technical support team or sales representative for technical support if you need additional assistance. Please have following information ready before you call:
 - Product name and serial number
 - Description of your peripheral attachments
 - Description of your software (operating system, version, application software, etc.)
 - A complete description of the problem
 - The exact wording of any error messages

Conventions Used in this Manual



WARNING
(AVERTIR)

This indication alerts operators to an operation that, if not strictly observed, may result in severe injury.

(Cette indication avertit les opérateurs d'une opération qui, si elle n'est pas strictement observée, peut entraîner des blessures graves.)



CAUTION
(ATTENTION)

This indication alerts operators to an operation that, if not strictly observed, may result in safety hazards to personnel or damage to equipment.

(Cette indication avertit les opérateurs d'une opération qui, si elle n'est pas strictement observée, peut entraîner des risques pour la sécurité du personnel ou des dommages à l'équipement.)



NOTE
(NOTE)

This indication provides additional information to complete a task easily.

(Cette indication fournit des informations supplémentaires pour effectuer facilement une tâche.)

Safety Precautions

Before installing and using this device, please note the following precautions.

1. Read these safety instructions carefully.
2. Keep this User's Manual for future reference.
3. Disconnect this equipment from any AC outlet before cleaning.
4. For plug-in equipment, the power outlet socket must be located near the equipment and must be easily accessible.
5. Keep this equipment away from humidity.
6. Put this equipment on a reliable surface during installation. Dropping it or letting it fall may cause damage.
7. Make sure the voltage of the power source is correct before connecting the equipment to the power outlet.
8. Use a power cord that has been approved for using with the product and that it matches the voltage and current marked on the product's electrical range label. The voltage and current rating of the cord must be greater than the voltage and current rating marked on the product.
9. Position the power cord so that people cannot step on it. Do not place anything over the power cord.
10. All cautions and warnings on the equipment should be noted.
11. If the equipment is not used for a long time, disconnect it from the power source to avoid damage by transient overvoltage.
12. Never pour any liquid into an opening. This may cause fire or electrical shock.
13. Never open the equipment. For safety reasons, the equipment should be opened only by

qualified service personnel.

If one of the following situations arises, get the equipment checked by service personnel:

- The power cord or plug is damaged.
- Liquid has penetrated into the equipment.
- The equipment has been exposed to moisture.
- The equipment does not work well, or you cannot get it work according to the user's manual.
- The equipment has been dropped and damaged.
- The equipment has obvious signs of breakage.

14. CAUTION: Risk of Explosion if Battery is replaced by an Incorrect Type. Dispose of Used Batteries According to the Instructions.

ATTENTION: Risque d'explosion si la batterie est remplacée par un type incorrect. Mettre au rebut les batteries usagées selon les instructions.

15. Equipment intended only for use in a RESTRICTED ACCESS AREA.

16. Output of the external power source shall be complied with ES1, PS3 requirements, output rating between 9-48 VDC, minimum 9.5-2A, with minimum rated maximum ambient temperature 70°C, and has to be evaluated according to UL/IEC/EN 60950-1 and/or UL/IEC/EN 62368-1. If need further assistance, please contact Cincoze for further information.

17. Ensure to connect the power cord of power adapter to a socket-outlet with earthing connection.

18. Dispose of used battery promptly. Keep away from children. Do not disassemble and do not dispose of in fire.

Package Contents

Before installation, please ensure all the items listed in the following table are included in the package.

Item	Description	Q'ty
1	DX-1200 Rugged Computer	1
2	CPU Heatsink Pack	1
3	Screw Pack	1
4	Wall Mounting Kit	1
5	Power Terminal Block Connector	1
6	Remote Power On/Off Terminal Block Connector	1
7	Fan Terminal Block Connector	1
8	DVI-I to VGA Adaptor	1

Note: Notify your sales representative if any of the above items are missing or damaged.

Ordering Information

Model No.	Product Description
DX-1200-R10	13/12th Gen. Intel® Core Series High Performance and Compact Rugged Embedded Computer



Chapter 1

Product Introductions

1.1 Overview

The DX-1200 is a fanless embedded computer that packs extreme performance into a rugged, compact chassis, making it the ideal choice for smart manufacturing, machine vision, and edge AI applications. 13th/12th gen Intel® Core™ (Raptor Lake-S/Alder Lake-S) processor (TDP up to 65W) and DDR5 4800 MHz memory provide high-speed computing performance, while additional functions, including rich native I/O and modular expansion design, meet the requirements for a wide range of applications.

1.2 Highlights

Rapid Processing and Inference

The DX-1200 supports 13/12th gen Intel® Core™ i9/i7/i5/i3 (Raptor Lake-S/Alder Lake-S) processors based on the Intel 7 process, with up to 24 cores (8P + 16E) and 32 threads, delivering more than 1.35x the speed of Comet Lake-S platform. The Intel® Xe architecture of the UHD 770 graphics chip boosts GPU image classification inference performance to 2.8x the speed of Comet Lake-S, providing the processing performance needed for AI and edge computing.

CPU Performance



GPU Image Classification Inference Performance

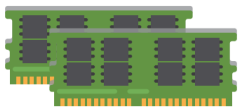

DDR5 ECC Memory

High-speed, Safe Memory

Two DDR5 SO-DIMM slots support up to 64GB of 4800MHz memory and include ECC (Error Correction Code) technology, giving the extra stability and reliability needed for industrial automation and control applications.

Rich and Diverse Expandability

To cater to the widest range of industrial applications, the DX-1200 provides one M.2 Key E slot and two Mini PCIe slots for the addition of WiFi, GNSS, 4G, and Bluetooth. The Mini PCIe slots also support I/O expansion cards, frame grabber cards, and more, to meet different application requirements.



High-speed, Reliable Data Transmission

To improve the transfer rate of videos or large files, the DX-1200 supports up to four high-speed 10Gbps LAN ports. And for application environments that require multiple network connections, the DX-1200 supports up to 8x PoE, providing data and power through the same cable to reduce the difficulty of wiring.

Robust and Reliable

The DX-1200 is built tough, reflected in its industrial-grade protection design and industry certifications in different fields. In addition to features such as wide temperature (-40 - 70°C), wide voltage input (9 - 48 VDC), overvoltage, overcurrent, and ESD protection, it also complies with the US military shock vibration standard MIL-STD-810G. Product safety and reliability are further ensured with internationally recognized UL 62368-1 safety certification. For more secure railway computing, it also passes the EMC EN 50121-3-2 standard in EN 50155 and the EN 45545-2 fire protection standard.



1.3 Product Pictures

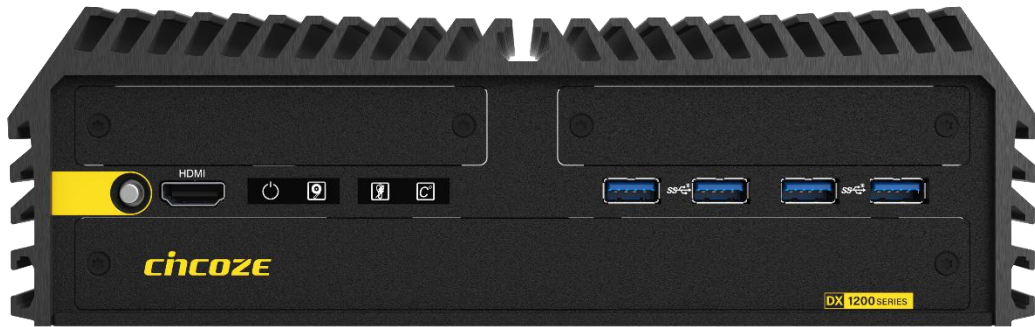

Front

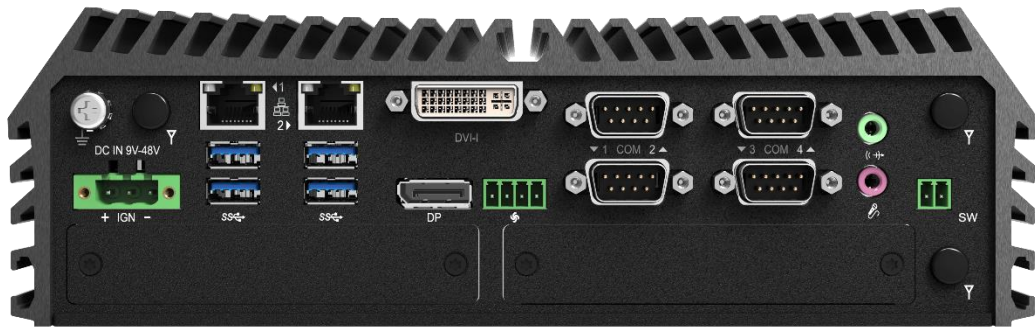

Rear

1.4 Key Features

- Intel® 13/12th Gen (Raptor Lake-S/Alder Lake-S) Core™ i9/i7/i5/i3 Processors (max 65 W TDP)
- 2 x DDR5 SO-DIMM Sockets, Supports ECC/non ECC type Memory, Up to 4800MHZ, 64GB
- Quad Independent Display (HDMI / DP / DVI-I)
- 1x M.2 Key E Type 2230 Socket for Intel CNVi / Wireless Module
- CMI Technology for Optional I/O Module Expansions
- CFM Technology for Power Ignition Sensing & PoE Function
- Wide Operating Temperature -40°C to 70°C
- Safety: UL, cUL, CB, IEC, EN 62368-1

1.5 Hardware Specification

System

Processor	<ul style="list-style-type: none"> • 13th Generation Intel® Raptor Lake-S Series CPU: <ul style="list-style-type: none"> - Intel® Core™ i9-13900E 24 Cores Up to 5.2 GHz, TDP 65W - Intel® Core™ i7-13700E 16 Cores Up to 5.1 GHz, TDP 65W - Intel® Core™ i5-13500E 14 Cores Up to 4.6 GHz, TDP 65W - Intel® Core™ i3-13100E 4 Cores Up to 4.4 GHz, TDP 60W - Intel® Core™ i9-13900TE 24 Cores Up to 5.0 GHz, TDP 35W - Intel® Core™ i7-13700TE 16 Cores Up to 4.8 GHz, TDP 35W - Intel® Core™ i5-13500TE 14 Cores Up to 4.5 GHz, TDP 35W - Intel® Core™ i3-13100TE 4 Cores Up to 4.1 GHz, TDP 35W • 12th Generation Intel® Alder Lake-S Series CPU: <ul style="list-style-type: none"> - Intel® Core™ i9-12900E 16 Cores Up to 5 GHz, TDP 65W - Intel® Core™ i7-12700E 12 Cores Up to 4.8 GHz, TDP 65W - Intel® Core™ i5-12500E 6 Cores Up to 4.5 GHz, TDP 65W - Intel® Core™ i3-12100E 4 Cores Up to 4.2 GHz, TDP 60W - Intel® Core™ i9-12900TE 16 Cores Up to 4.8 GHz, TDP 35W - Intel® Core™ i7-12700TE 12 Cores Up to 4.7 GHz, TDP 35W - Intel® Core™ i5-12500TE 6 Cores Up to 4.3 GHz, TDP 35W - Intel® Core™ i3-12100TE 4 Cores Up to 4.0 GHz, TDP 35W - Intel® Pentium® G7400E 2 Cores Up to 3.6 GHz, TDP 46W - Intel® Pentium® G7400TE 2 Cores Up to 3.0 GHz, TDP 35W - Intel® Celeron® G6900E 2 Cores Up to 3.0 GHz, TDP 46W - Intel® Celeron® G6900TE 2 Cores Up to 2.4 GHz, TDP 35W
Chipset	<ul style="list-style-type: none"> • Intel R680E Chipset
Memory	<ul style="list-style-type: none"> • 2x DDR5 4800 MHz SO-DIMM Socket, Supports Un-buffered and ECC Type, Up to 64GB
BIOS	<ul style="list-style-type: none"> • AMI BIOS
Graphics	
Graphics Engine	<ul style="list-style-type: none"> • Integrated Intel® UHD Graphics 770: Core™ i9/i7/i5 • Integrated Intel® UHD Graphics 730: Core™ i3 • Integrated Intel® UHD Graphics 710: Pentium®/Celeron®
Maximum Display Output	<ul style="list-style-type: none"> • Supports Quad Independent Display
DVI	<ul style="list-style-type: none"> • 1x DVI-I Connector <ul style="list-style-type: none"> - VGA: 1920 x 1080 @ 60 Hz - DVI-D: 1920 x 1200 @ 60 Hz

DP	<ul style="list-style-type: none"> • 1x DP Connector: 4096 x 2304 @ 60Hz * Verified maximum resolution: 3840 x 2160 @ 60Hz
HDMI	<ul style="list-style-type: none"> • 1x HDMI Connector: 3840 x 2160 @ 30Hz
Audio	
Audio Codec	<ul style="list-style-type: none"> • Realtek® ALC888, High Definition Audio
Line-out	<ul style="list-style-type: none"> • 1x Line-out, Phone Jack 3.5mm
Mic-in	<ul style="list-style-type: none"> • 1x Mic-in, Phone Jack 3.5mm
I/O	
LAN	<ul style="list-style-type: none"> • 2x 1GbE LAN, RJ45(Supports Wake on LAN, PXE) - GbE1: Intel® I219 - GbE2: Intel® I210
COM	<ul style="list-style-type: none"> • 4x RS-232/422/485 with Auto Flow Control (Supports 5V/12V), DB9
USB	<ul style="list-style-type: none"> • 4x 10Gbps USB 3.2 Gen2, Type A • 4x 5Gbps USB 3.2 Gen1, Type A
Storage	
SSD/HDD	<ul style="list-style-type: none"> • 2x 2.5" SATA HDD/SSD Bay (SATA 3.0)
mSATA	<ul style="list-style-type: none"> • 2x mSATA Socket (SATA 3.0, shared by Mini-PCIe socket)
RAID	<ul style="list-style-type: none"> • Support RAID 0/1/5/10
Expansion	
Mini PCI Express	<ul style="list-style-type: none"> • 2x Full-size Mini-PCIe Socket
M.2 E Key Socket	<ul style="list-style-type: none"> • 1x M.2 Key E Type 2230 Socket, Support Intel CNVi Module
SIM Socket	<ul style="list-style-type: none"> • 1x SIM Socket
CFM (Control Function Module) Interface	<ul style="list-style-type: none"> • 2x High Speed CMI Interface for optional CMI Module Expansion • 1x Low Speed CMI Interface for optional CMI Module Expansion
CDS (Convertible Display System) Interface	<ul style="list-style-type: none"> • 1x CFM IGN Interface for optional CFM-IGN Module Expansion
Other Function	
External FAN Connector	<ul style="list-style-type: none"> • 1x External FAN Connector, 4-pin Terminal Block (Support Smart Fan by BIOS)
Clear CMOS Switch	<ul style="list-style-type: none"> • 1x Clear CMOS Switch

Reset Button	<ul style="list-style-type: none"> • 1x Reset Button
Instant Reboot	<ul style="list-style-type: none"> • Support 0.2sec Instant Reboot Technology
Watchdog Timer	<ul style="list-style-type: none"> • Software Programmable Supports 256 Levels System Reset
Power	
Power Button	<ul style="list-style-type: none"> • 1x ATX Power On/Off Button
Power Mode Switch	<ul style="list-style-type: none"> • 1x AT/ATX Mode Switch
Power Input	<ul style="list-style-type: none"> • 9-48VDC, 3-pin Terminal Block
Remote Power On/Off	<ul style="list-style-type: none"> • 1x Remote Power On/Off, 2-pin Terminal Block
Physical	
Dimension (W x D x H)	<ul style="list-style-type: none"> • 242 x 173 x 75 mm
Weight Information	<ul style="list-style-type: none"> • 3.05 kg
Mechanical Construction	<ul style="list-style-type: none"> • Extruded Aluminum with Heavy Duty Metal
Mounting	<ul style="list-style-type: none"> • Wall / DIN-RAIL / VESA / Side Mount
Physical Design	<ul style="list-style-type: none"> • Fanless Design • Cableless Design • Jumper-less Design • Unibody Design
Reliability & Protection	
Reverse Power Input Protection	<ul style="list-style-type: none"> • Yes
Over Voltage Protection	<ul style="list-style-type: none"> • Protection Range: 51-58V • Protection Type: shut down operating voltage, re-power on at the present level to recover
Over Current Protection	<ul style="list-style-type: none"> • 15A
CMOS Battery Backup	<ul style="list-style-type: none"> • SuperCap Integrated for CMOS Battery Maintenance-free Operation
MTBF	<ul style="list-style-type: none"> • 394,488 Hours - Database: Telcordia SR-332 Issue3, Method 1, Case 3
Operating System	
Windows	<ul style="list-style-type: none"> • Windows®11, Windows®10
Linux	<ul style="list-style-type: none"> • Ubuntu 22.04

Environment	
Operating Temperature	<ul style="list-style-type: none"> • 35W TDP Processor: -40°C to 70°C • 65W TDP Processor: -40°C to 50°C (With External Fan Kit) * With extended temperature peripherals; Ambient with air flow * According to IEC60068-2-1, IEC60068-2-2, IEC60068-2-14
Storage Temperature	<ul style="list-style-type: none"> • -40°C to 85°C
Relative Humidity	<ul style="list-style-type: none"> • 95% RH @ 70°C (Non-condensing)
Shock	<ul style="list-style-type: none"> • MIL-STD-810G
Vibration	<ul style="list-style-type: none"> • MIL-STD-810G
EMC	<ul style="list-style-type: none"> • CE, UKCA, FCC, ICES-003 Class A • EN 50155 (EN 50121-3-2 Only) • E-mark
EMI	<ul style="list-style-type: none"> • CISPR 32 Conducted & Radiated: Class A • EN/BS EN 50121-3-2 Conducted & Radiated: Class A • EN/BS EN IEC 61000-3-2 Harmonic current emissions: Class A • EN/BS EN61000-3-3 Voltage fluctuations & flicker • FCC 47 CFR Part 15B, ICES-003 Conducted & Radiated: Class A
EMS	<ul style="list-style-type: none"> • EN/IEC 61000-4-2 ESD: Contact: 6 kV; Air: 8 kV • EN/IEC 61000-4-3 RS: 80 MHz to 1000 MHz: 20 V/m • EN/IEC 61000-4-4 EFT: AC Power: 2 kV; Signal: 2 kV • EN/IEC 61000-4-5 Surges: AC Power: 2 kV • EN/IEC 61000-4-6 CS: 10V • EN/IEC 61000-4-8 PFMF: 50 Hz, 1A/m • EN/IEC 61000-4-11 Voltage Dips & Voltage Interruptions: 0.5 cycles at 50 Hz
Safety	<ul style="list-style-type: none"> • UL, cUL, CB, IEC, EN 62368-1
Fire Protection	<ul style="list-style-type: none"> • EN 45545-2

** Product Specifications and features are for reference only and are subject to change without prior notice. For more information, please refer to the latest product datasheet from Cincoze's website.*

1.6 System I/O

1.6.1 Front

ATX Power ON/OFF

Used to power-on or power-off the system

HDMI

Used to connect the system with HDMI monitor

Power LED

Indicates the power status of the system

HDD LED

Indicates the status of the hard drive

IGN LED

Indicates the status of the IGN function

Temperature LED

Indicates the temperature of the system

Universal I/O Expansion (High Speed CMI Interface)

Used to customized I/O output with optional modules

USB 3.2 Gen2

Used to connect USB 3.2 GEN2/3.2 GEN1/ 2.0/1.1 device

IGN Setting Switch

Used to set up IGN function

SIM Card

Used to insert a SIM card

CMOS Battery

Used to insert a CMOS Battery

Clear BIOS Switch

Used to reset BIOS

Reset Button

Used to reset the system

AT/ATX Mode Select Switch

Used to select AT or ATX power mode

2.5" Hot Swap HDD/SSD Bay

Used to insert a 2.5" SATA HDD/SSD

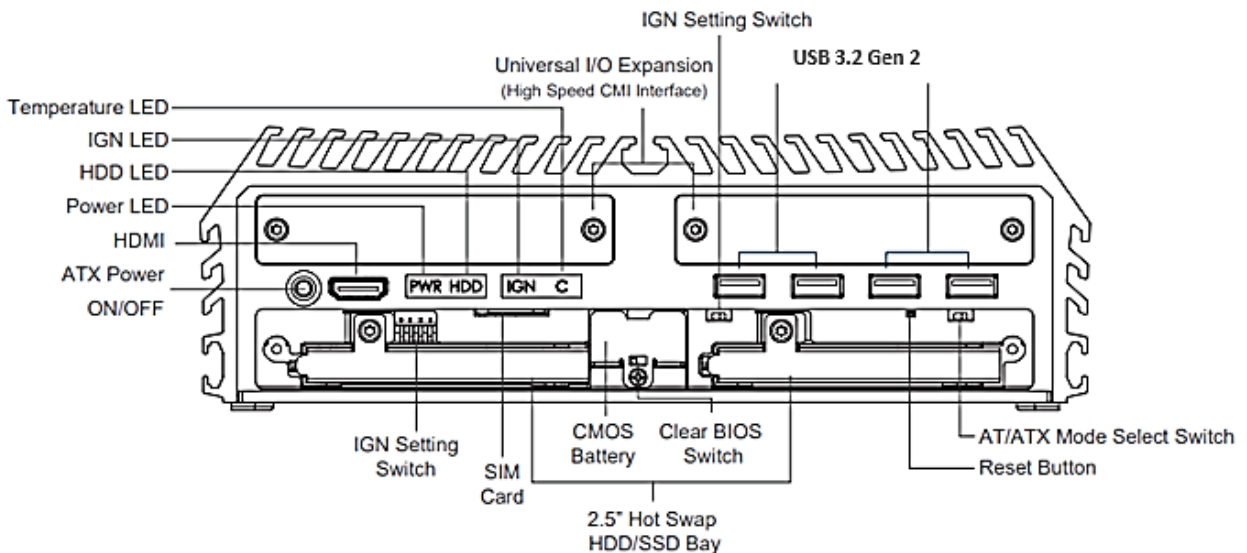

1.6.2 Rear

DC IN

Used to plug a DC power input with terminal block

Antenna

Used to connect an antenna for optional wireless module

LAN1, LAN2

Used to connect to local area network

USB 3.2 Gen1

Used to connect USB 3.2 GEN2/3.2 GEN1/ 2.0/1.1 device

DP1

Used to connect a monitor with DisplayPort interface

DVI-I

Used to connect a DVI monitor or connect optional split cable for dual display mode

COM1, COM2, COM3, COM4

Used to connect to RS-232/422/485 serial devices

Line-out

Used to connect a speaker

Mic-in

Used to connect a microphone

Remote Power On/Off

A terminal block used to connect to remote power on/off switch

Universal I/O Expansion

(Low Speed CMI Interface)

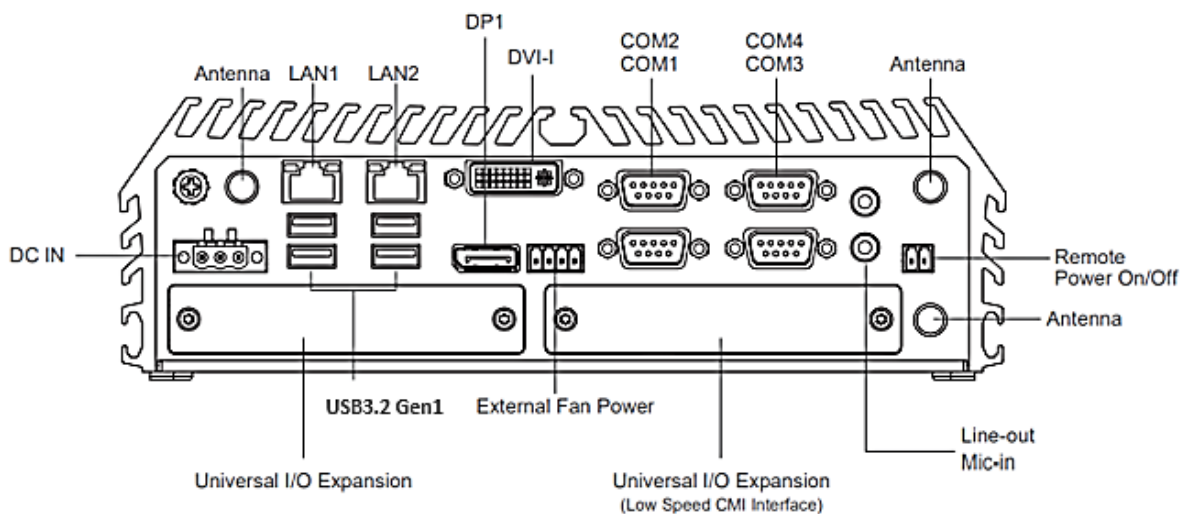

Used to customized I/O output with optional modules

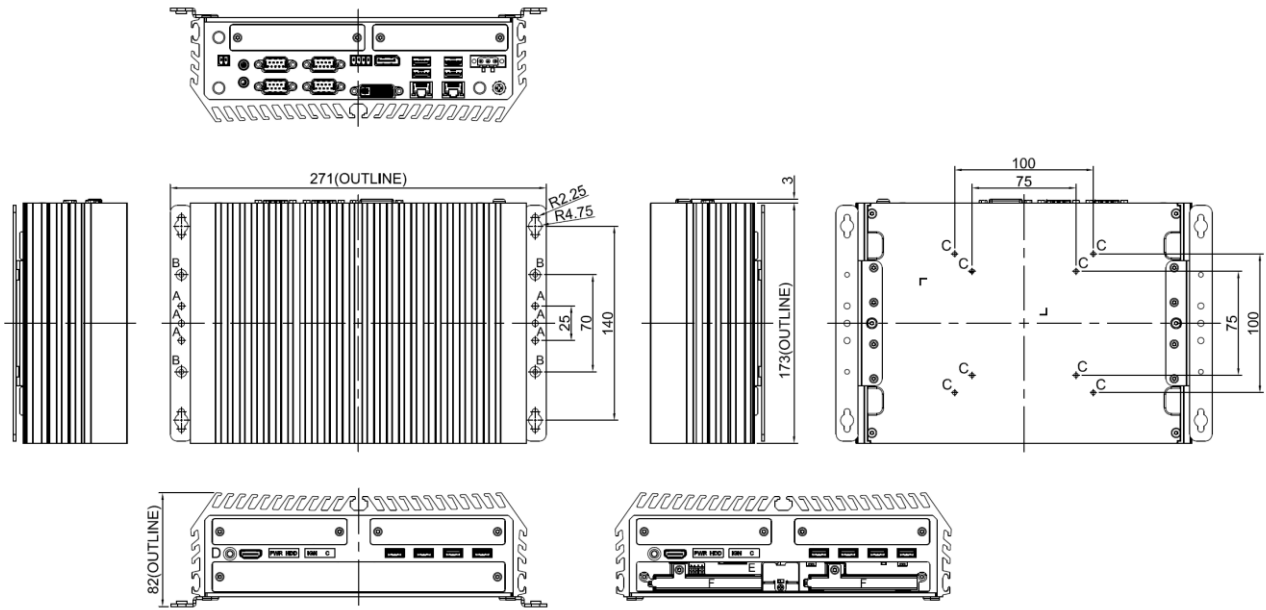

1.7 Mechanical Dimension

Unit: mm





Chapter 2

Switches & Connectors

2.1 Location of Switches and Connectors

2.1.1 Top View

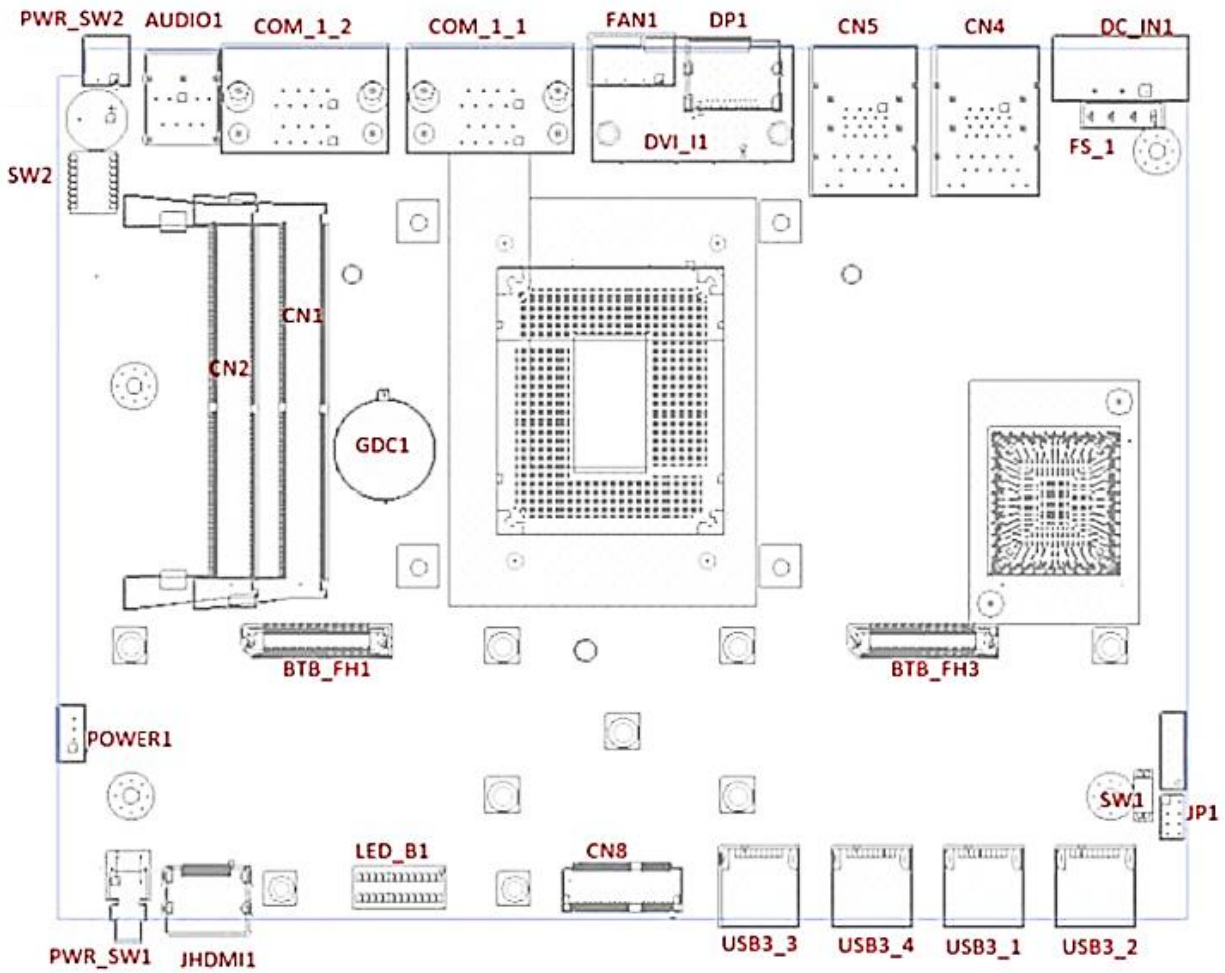

2.1.2 Bottom View

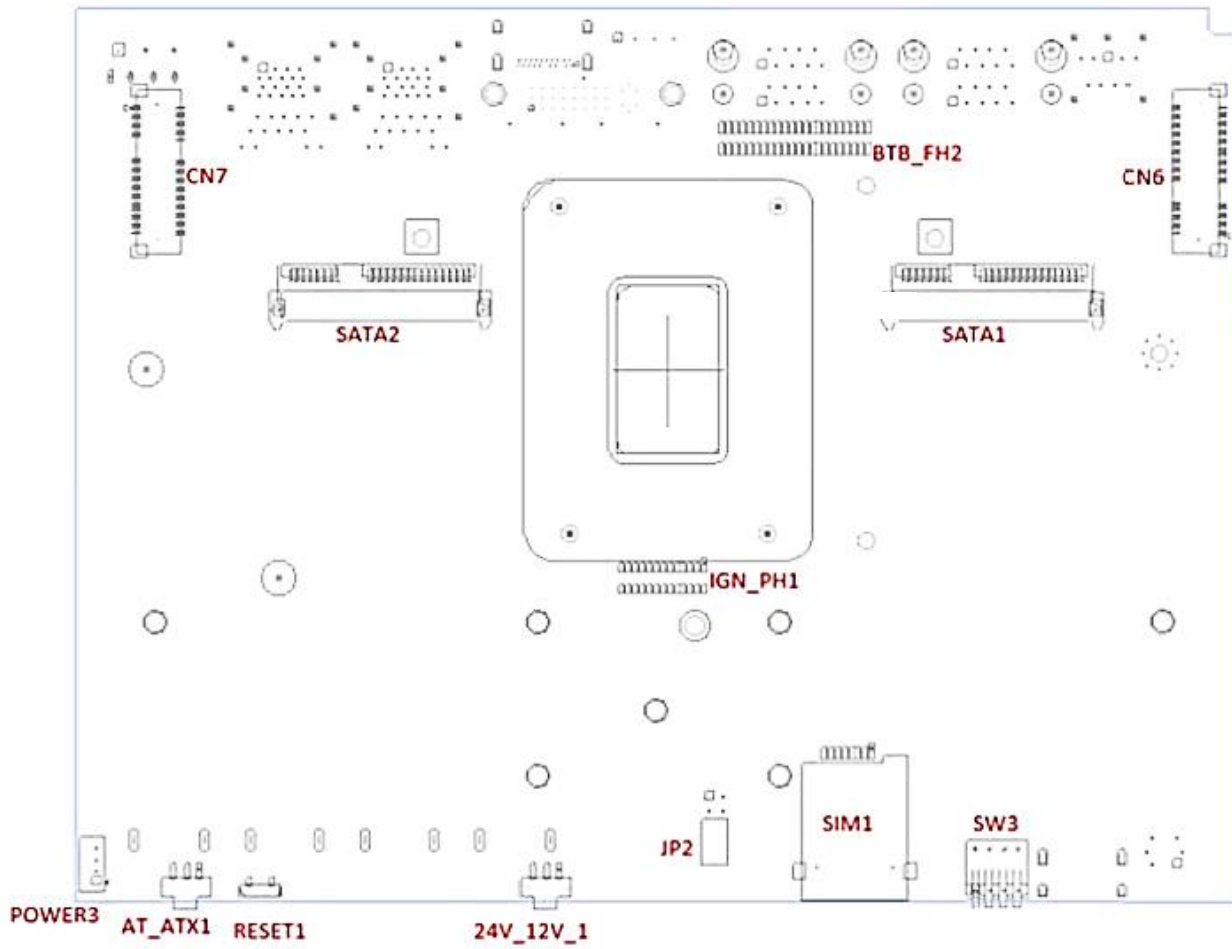

2.2 Switches and Connectors Definition

Connector	Definition
AT_ATX1	AT / ATX Power Mode Switch
PWR_SW1	ATX Power on/off Button
RESET1	System Reset Button
SW1	Super CAP Switch
CLR_CMOS1	Clear CMOS Switch
SW2	COM1~COM4 Power Select
DC_IN1	DC +9V-48V Power Connector
CN4 / CN5	LAN Connector + USB3.2 GEN1 Connector
DP1	Display Port Connector
FAN1	FAN Connector
DVI_I1	DVI_I Connector
COM_1_1 / COM_1_2	COM1~COM4 Connector, support RS232/RS422/ RS485
AUDIO1	Audio Jack, MIC_IN/LINE_OUT
PWR_SW2	Remote Power on/off Connector
CN1 / CN2	DDR5 SO-DIMM Slot
GDC1	Super CAP for CMOS Backup
BTB_FH1 / BTB_FH3	POE LAN Module Board to Board Connectors
USB3_1 / USB3_2 / USB3_3 / USB3_4	USB 3.2 GEN2 Connector
CN8	M.2 Key E Connector (support PCIE/ CNVi WIFI module)
LED_B1	LED Connector for PWR LED, HDD LED, IGN LED, TEMP LED
JHDMI1	HDMI Connector
FS_1	Input Power Fuse 15A Connector
JP1	BIOS SPI interface
POWER1 / POWER3	+5V / +12V Power Output Connectors
CN6	MINI PCIE Connector (support PCIE/ mSATA/ USB3.2/ SIM)
CN7	MINI PCIE Connector (support PCIE/ mSATA)
BTB_FH2	DIO or COM (COM5/COM6) Module Board to Board Connector
SATA1 / SATA2	SATA Connector
IGN_PH1	IGN Module Board to Board Connector
SIM1	SIM Card Socket
JP2	RTC Battery Board to Board Connector
SW3	IGN Module Time Setting Switch
24V_12V_1	IGN Module Voltage Mode Setting Switch

2.3 Definition of Switches

AT_ATX1: AT / ATX Power Mode Switch

Switch	Definition
1-2 (Left)	AT Power Mode
2-3 (Right)	ATX Power Mode (Default)



Reset1: System Reset Button

Button	Definition
Push	Reset System



PWR_SW1: ATX Power on/off Button

Switch	Definition
Push	Power on System



SW1: Super CAP Switch

DIP	Function	ON	OFF
1	Super CAP	Enable (Default)	Disable
2	N/A	N/A	N/A



CLR_CMOS1: Clear CMOS Switch

Pin	Definition
1-2 (Left)	Normal Status (Default)
2-3 (Right)	Clear CMOS



WARNING
(AVERTIR)

After performing Clear CMOS, the system will take several minutes to start. This is normal. During this process, the system will POST three times, and the system's Power LED will alternate between green and blue lights.

(Après avoir effectué Clear CMOS, le système prendra plusieurs minutes pour démarrer. Cela est normal. Pendant ce processus, le système effectuera trois fois le POST, et la LED d'alimentation du système alternera entre les lumières verte et bleue.)

SW2: COM1~COM4 Power Select

COM1 / 2 / 3 / 4 Voltage Function Setting via DIP Switch

Location	Function		DIP1	DIP2
SW2	COM1	0V(RI)	ON (Default)	ON (Default)
		5V	ON	OFF
		12V	OFF	OFF

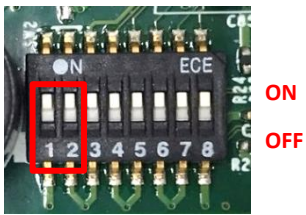

Location	Function		DIP3	DIP4
SW2	COM2	0V(RI)	ON (Default)	ON (Default)
		5V	ON	OFF
		12V	OFF	OFF

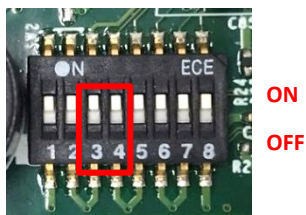

Location	Function		DIP5	DIP6
SW2	COM3	0V(RI)	ON (Default)	ON (Default)
		5V	ON	OFF
		12V	OFF	OFF

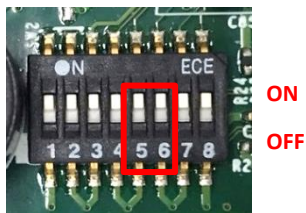

Location	Function		DIP7	DIP8
SW2	COM4	0V(RI)	ON (Default)	ON (Default)
		5V	ON	OFF
		12V	OFF	OFF

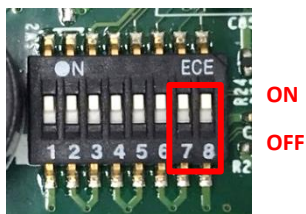

2.4 Definition of Connectors

CN6: Mini PCI-Express Socket (support PCIE/ mSATA/ USB3.2/ SIM)

Pin No.	PIN Name	Pin No.	Pin name
1	WAKE#	2	3.3V
3	NC	4	GND
5	NC	6	1.5V
7	NC	8	UIM_PWR
9	GND	10	UIM_DATA
11	REFCLK-	12	UIM_CLK
13	REFCLK+	14	UIM_RST
15	GND	16	UIM_VPP
Mechanical Key			
17	NC	18	GND
19	NC	20	3.3V
21	GND	22	PERST#
23	SATA_RXP/ PCIE_RXN/ USB3_RXN	24	3.3V
25	SATA_RXN/ PCIE_RXP/ USB3_RXP	26	GND
27	GND	28	1.5V
29	GND	30	SMB_CLK
31	SATA_TXN/ PCIE_TXN/ USB3_TXN	32	SMB_DATA
33	SATA_TXP/ PCIE_TXP/ USB3_TXP	34	GND
35	GND	36	USB_D-
37	GND	38	USB_D+
39	3.3V	40	GND
41	3.3V	42	NC
43	GND	44	NC
45	NC	46	NC
47	NC	48	1.5V
49	NC	50	GND
51	SATA_DET	52	3.3V

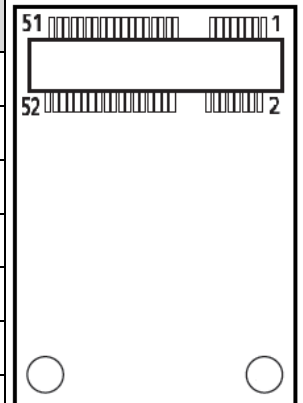

CN7 : Mini PCI-Express Socket (support PCIE/ mSATA)

Pin No.	PIN Name	Pin No.	Pin name
1	WAKE#	2	3.3V
3	NC	4	GND
5	NC	6	1.5V
7	NC	8	NC
9	GND	10	NC
11	REFCLK-	12	NC
13	REFCLK+	14	NC
15	GND	16	NC
Mechanical Key			
17	NC	18	GND
19	NC	20	3.3V
21	GND	22	PERST#
23	SATA_RXP/ PCIE_RXN	24	3.3V
25	SATA_RXN/ PCIE_RXP	26	GND
27	GND	28	1.5V
29	GND	30	SMB_CLK
31	SATA_TXN/ PCIE_TXN	32	SMB_DATA
33	SATA_TXP/ PCIE_TXP	34	GND
35	GND	36	USB_D-
37	GND	38	USB_D+
39	3.3V	40	GND
41	3.3V	42	NC
43	GND	44	NC
45	NC	46	NC
47	NC	48	1.5V
49	NC	50	GND
51	SSD_DET	52	3.3V

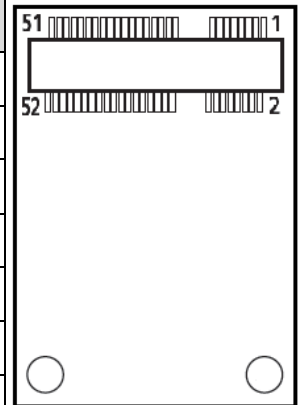

CN8 : M.2 Key E Socket (support PCIE / CNVi WIFI module)

Pin No.	PIN Name	Pin NO.	Pin name
1	GND	2	3.3V
3	USB_D+	4	3.3V
5	USB_D-	6	NC
7	GND	8	PCM_CLK
9	WGR_D1N	10	PCM_SYNC
11	WGR_D1P	12	PCM_IN
13	GND	14	PCM_OUT
15	WGR_D0N	16	NC
17	WGR_D0P	18	GND
19	GND	20	UART_WAKE
21	WGR_CLKN	22	BRI_RSP
23	WGR_CLKP	24	Key
25	Key	26	Key
27	Key	28	Key
29	Key	30	Key
31	Key	32	RGI_DT
33	GND	34	RGI_RSP
35	PETPO	36	BRI_DT
37	PETNO	38	CLINK_REST
39	GND	40	CLINK_DATA
41	PERPO	42	CLINK_CLK
43	PERNO	44	COEX3
45	GND	46	COEX_TXD
47	REFCLKP0	48	COEX_RXD
49	REFCLKN0	50	SUSCLK
51	GND	52	PERST0#
53	NC	54	NC
55	PEWAKE0#	56	W_DISABLE1#
57	GND	58	I2C_DATA
59	WTD1N/PETP1	60	I2C_CLK
61	WTD1P/PETN1	62	NC
63	GND	64	NC
65	WT_D0N/PERP1	66	NC
67	WT_D0P/PERN1	68	NC

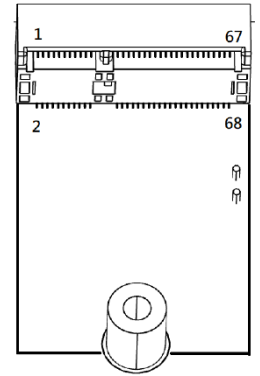

69	GND	70	PEWAKE1#
71	WTCLKN/REFCLKP1	72	3.3V
73	WTCLKP/REFCLKN1	74	3.3V
75	GND		

DC_IN1: DC Power Input Connector (+9-48V)

Connector Type: Terminal Block 1x3 3-pin, 5.0mm pitch

Pin	Definition
1	+9-48VIN
2	Ignition (IGN)
3	GND

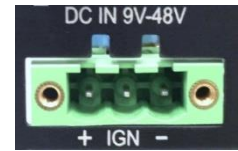

1 2 3



CAUTION
(ATTENTION)

Please disconnect the power source before mounting the DC power cables or connecting the DC power connector to system.

(Veuillez débrancher la source d'alimentation avant de monter les câbles d'alimentation CC ou de connecter le connecteur d'alimentation CC au système.)

PWR_SW2: Power On/Off Switch Connector

Connector Type: Terminal Block 1X2 2-pin, 3.5mm pitch

Pin	Definition
1	PWR_SW
2	GND



1 2



WARNING
(AVERTIR)

Do not apply power to this connector! This port is used to connect a SWITCH!

(Ne mettez pas sous tension ce connecteur! Ce port est utilisé pour connecter un SWITCH!)

CN4 / CN5: LAN1 / 2 LED Status Definition

Act LED Status	Definition
Blinking Yellow	Data Activity
Off	No Activity

Link LED Status	Definition
Steady Green	1Gbps Network Link
Steady Orange	100Mbps Network Link
Off	10Mbps Network Link

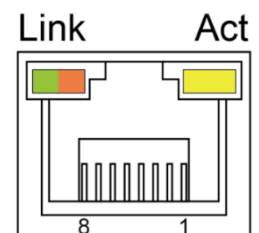

FAN1: External Fan Connector

Connector Type: Terminal Block 1X4 4-pin, 3.5mm pitch

Pin	Definition
1	GND
2	+12V
3	SENSE
4	Control



COM1~COM4: RS232 / RS422 / RS485 Connector

Connector Type: 9-pin D-Sub

Pin	RS232 Definition	RS422 / 485 Full Duplex Definition	RS485 Half Duplex Definition
1	DCD	TX-	DATA -
2	RXD	TX+	DATA +
3	TXD	RX+	
4	DTR	RX-	
5	GND		
6	DSR		
7	RTS		
8	CTS		
9	RI		



Power1/ Power3: +5V / +12V Power Output Connectors

Connector Type: 1x4 4-pin Wafer, 2.0mm pitch

Pin	Definition
1	+5V
2	GND
3	GND
4	+12V

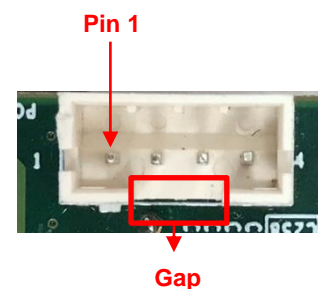

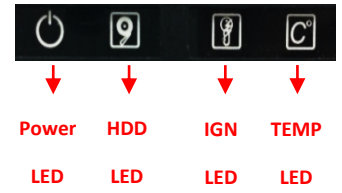

LED_B1: PWR / HDD / IGN / TEMP LED Status

LED B1	Status	LED Color
Power LED	Power ON	Green
	Standby	Blinking Green and Blue
	Power Off	Blue
HDD LED	HDD Read/Write	Blinking Yellow
IGN LED	IGN Disabled	Colorless
	IGN Enabled	Blue
	ACC ON	Green
TEMP LED	System Temp $\leq 65^{\circ}\text{C}$	Colorless
	$65^{\circ}\text{C} < \text{System Temp} \leq 70^{\circ}\text{C}$	Blue
	$70^{\circ}\text{C} < \text{System Temp} \leq 75^{\circ}\text{C}$	Red
	$75^{\circ}\text{C} < \text{System Temp}$	Blinking Red



**NOTE
(NOTE)**

The TEMP LED is only available when IGN module is installed.
(La LED TEMP n'est disponible que lorsque le module IGN est installé.)



Chapter 3

System Setup

3.1 Removing Top Cover



WARNING
(AVERTIR)

In order to prevent electric shock or system damage, must turn off power and disconnect the unit from power source before removing the chassis cover.

(Afin d'éviter tout risque d'électrocution ou d'endommagement du système, vous devez couper l'alimentation et débrancher l'appareil de la source d'alimentation avant de retirer le couvercle du châssis.)

1. Turn over the unit and have the bottom side face up, loosen the 6 screws on the bottom cover and place them aside for later use.



2. Remove the bottom cover from the chassis.



3. Loosen the 4 screws. Pull out the 4 latches as marked on photo.

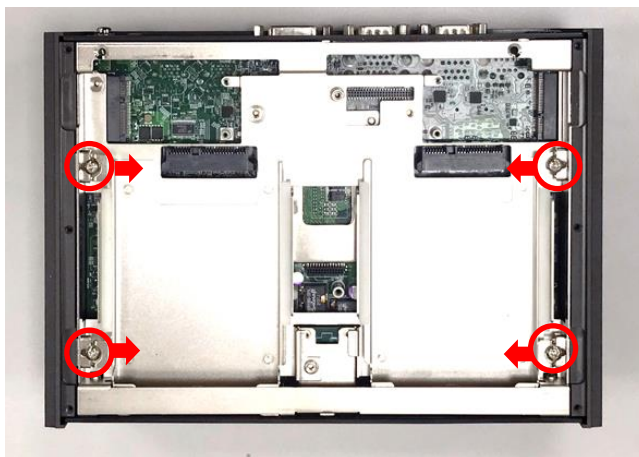

4. Hold the front and rear panels and lift up the body of unit vertically.



5. Turn over the body of the unit and place it gently.

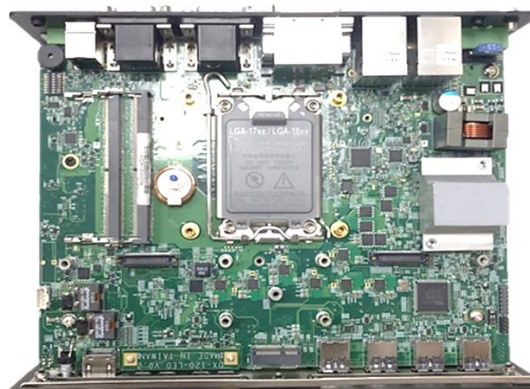

3.2 Installing CPU



WARNING
(AVERTIR)

After replacing the CPU, please perform a Clear CMOS before powering on. According to Intel documentation (Clear CMOS after Hardware Configuration Change, Document Number: 337986-001), if you do not perform a Clear CMOS, the BIOS will apply settings from the old CPU to the new CPU, which may cause performance issues or startup failures. Therefore, Cincoze performs a Clear CMOS procedure before shipping. When customers power on the system for the first time, it will take several minutes to start. This is normal. During this process, the system will POST three times, and the Power LED will alternate between green and blue lights.

(Après avoir remplacé le CPU, veuillez effectuer un Clear CMOS avant de mettre sous tension. Selon la documentation Intel (Clear CMOS after Hardware Configuration Change, Document Number: 337986-001), si vous n'effectuez pas un Clear CMOS, le BIOS appliquera les paramètres de l'ancien CPU au nouveau CPU, ce qui peut entraîner des problèmes de performance ou des échecs de démarrage. Par conséquent, Cincoze effectue une procédure de Clear CMOS avant l'expédition. Lorsque les clients mettent le système sous tension pour la première fois, il faudra plusieurs minutes pour démarrer. Cela est normal. Pendant ce processus, le système effectuera trois fois le POST et la LED d'alimentation alternera entre les lumières verte et bleue.)

1. Locate the CPU socket, remove the protection cover on it.

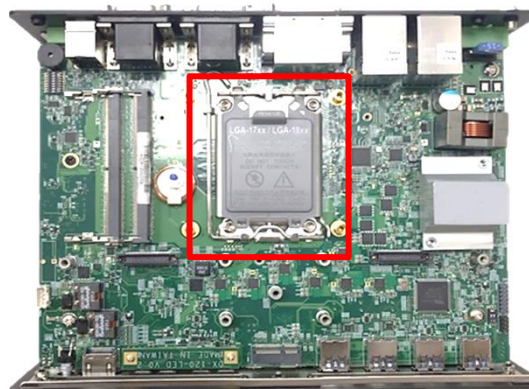

2. Pull up the lever.



3. Lift up the holder.

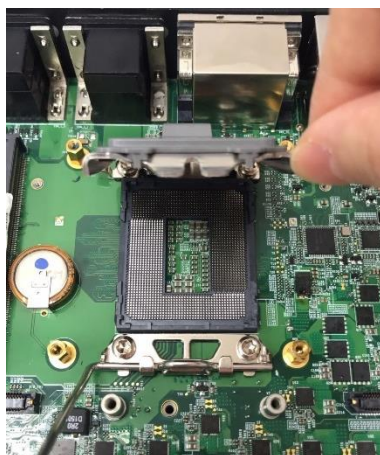

4. Align the CPU with the fool-proof protrusions on the socket and put on the CPU.



5. Press down the holder, and the cover will be automatically removed.

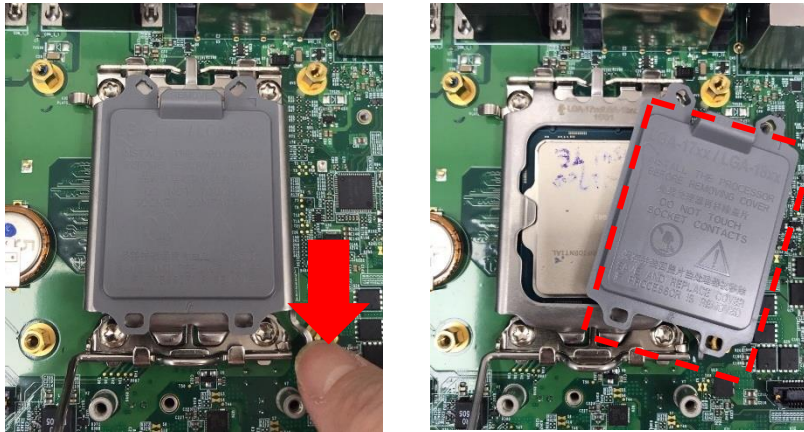

6. Press the lever back to its original place to lock the CPU.



7. Make sure that the CPU is clean, and apply the thermal paste onto the center of the CPU's surface as shown below. For more information about the thermal paste application, please find the [Intel official website](#).



- Put on the thermal block horizontally gently with aligning the 4 screw holes. Next, gently rotate the thermal block clockwise. (This is to ensure even distribution of the thermal paste onto the CPU's surface.) Note that the "Front" sign should be close to the system front panel.



- Fasten the 4 screws.

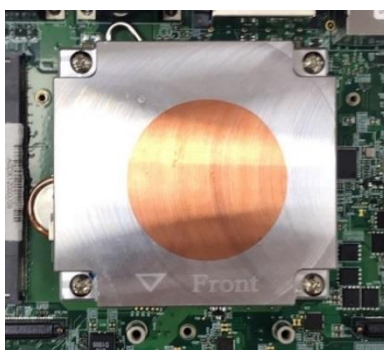

- Peel off the protective transparent films on both sides of the thermal pad, and paste the thermal pad onto the thermal block. Please note to have the purple side face down and the grey side face up.



3.3 Installing SO-DIMM Memory

1. Locate the SODIMM socket on the top side of system.

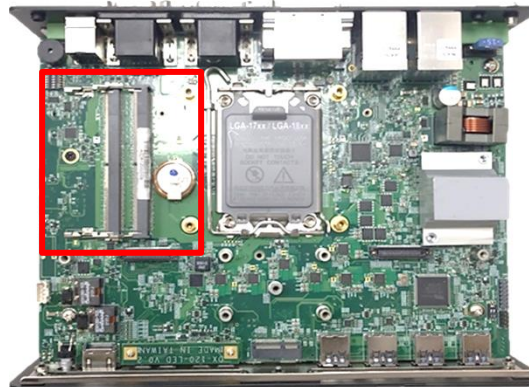

2. Insert a SO-DIMM at a 45-degree angle until its edge connector is connected to SO-DIMM socket firmly.



Lower socket

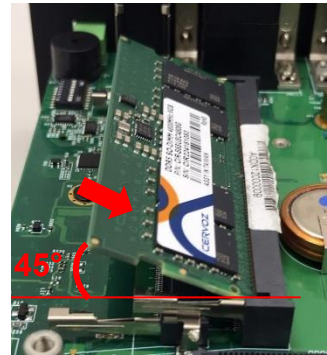

Upper socket

3. Press down the module until the retaining clips snap back in place.



Lower socket



Upper socket

3.4 Installing Mini-PCle/mSATA Card

1. Locate the Mini PCIe socket(s) on the bottom side of the system.

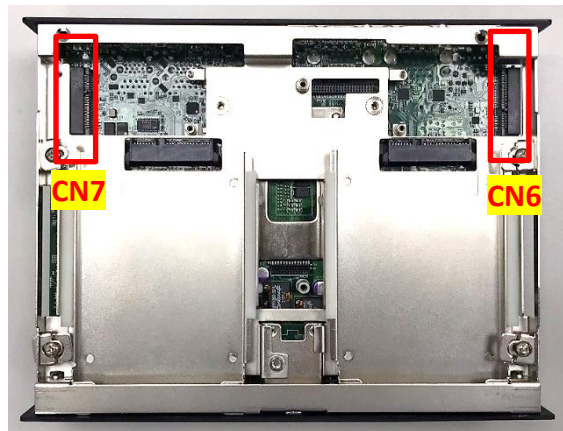

2. Insert the Mini-PCle card at a 45-degree angle until its edge connector is connected firmly into slot. For 3G/4G Mini-PCle card, please install onto CN6 slot.

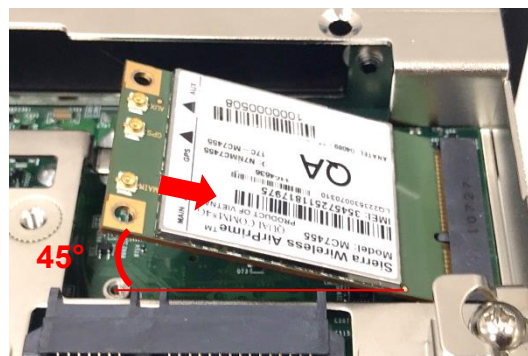

3. Press the card down and secure it with 2 screws.



3.5 Installing M.2 E Key Card

1. Locate the M.2 E Key slot (CN8) on the system motherboard.

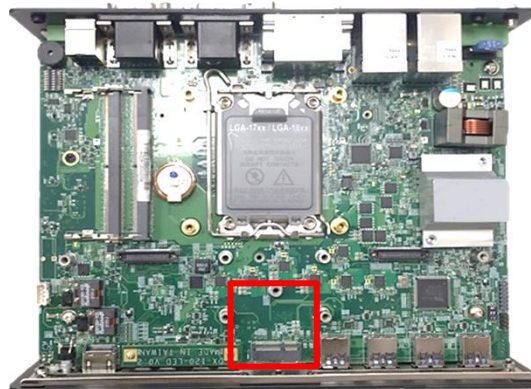

2. Tilt the M.2 E Key card at a 45-degree angle and insert it to the socket until the golden finger connector of the card seated firmly.



3. Press the card down and secure it with 1 screw.

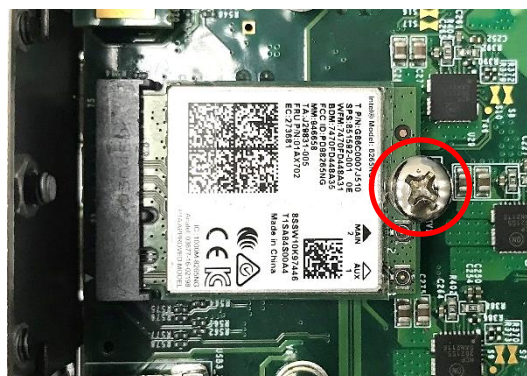

3.6 Installing Antenna(s)

Please find the picture below. For Antenna number 1 or 2, please refer to the chapter 3.6.1 to install the antenna. For Antenna number 3, please refer to the chapter 3.6.2 to install the antenna.



3.6.1 For Antenna 1 or 2

4. Remove the antenna rubber cover on the rear panel.



5. Penetrate the antenna jack through the hole.

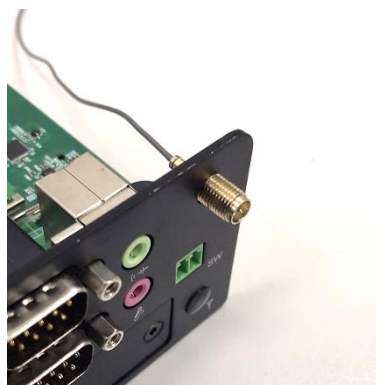

6. Put on washer and fasten the nut with antenna jack.



7. Assemble the antenna and antenna jack together.



8. Attach the RF connector at the other end of cable onto the module's main or auxiliary port. (The main port's signal is stronger than the auxiliary's signal.)



3.6.2 For Antenna 3

1. Remove the antenna rubber cover on the rear panel.



2. Loosen the 10 D-Sub jack screws on rear panel to remove the rear panel



3. Penetrate the antenna jack.

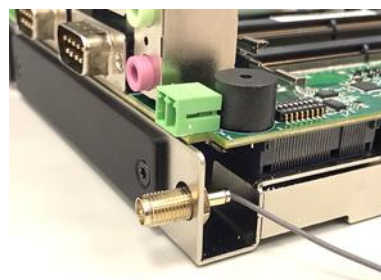

4. Put on the rear panel back and fasten the 10 D-Sub jack screws on it.



5. Put on washer and fasten the nut with antenna jack.



6. Assemble the antenna and antenna jack together.



4. Attach the RF connector at the other end of cable onto the module's main or auxiliary port. (The main port's signal is stronger than the auxiliary's signal.)



3.7 Installing Top Cover

1. Hold the front and rear panels and put the body of unit back to chassis vertically.



2. Push into the 4 latches and fasten the 4 screws.

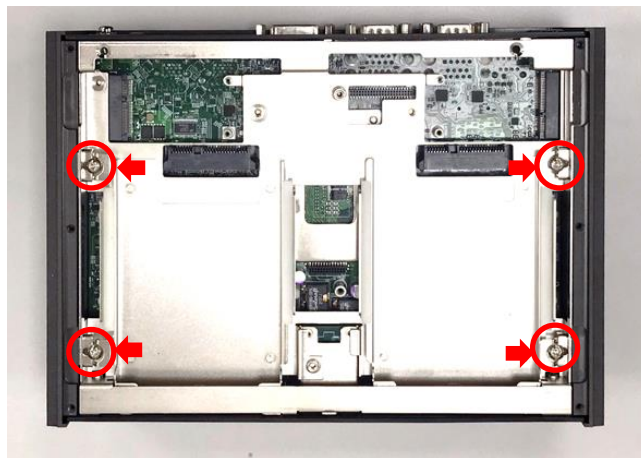

3.8 Installing Bottom Cover

1. Place the bottom cover back to system.



2. Fasten the bottom cover with 6 screws.



3.9 Removing Maintenance Cover

1. Loosen the 2 screws on the front panel to remove the maintenance cover plate.



3.10 Installing SATA HDD/SSD

1. After removing the maintenance cover, locate the removable HDD bay and loosen the screw(s).



2. Pull the rotating arm and pull the HDD bracket out of system.

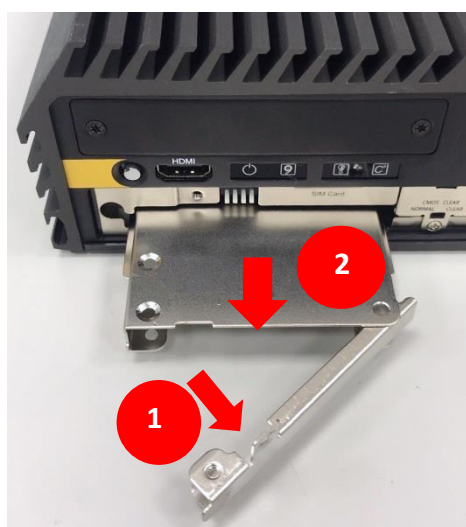

3. Make the bottom side of the HDD face up, place the HDD bracket on it. Ensure the direction of bracket is correct and use 4 provided screws to assemble HDD and HDD bracket together.

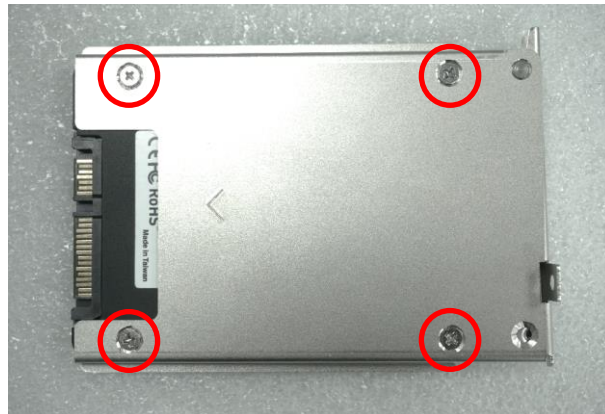

4. Align the HDD bracket assembly with the entrance of removable HDD bay. Holding the rotating arm and insert the HDD bracket until the connector of HDD contact the SATA connector firmly.



5. Place the rotating arm back and fasten the screw(s).



3.11 Installing SIM Card

1. After removing the maintenance cover, locate the SIM card slot at front side.

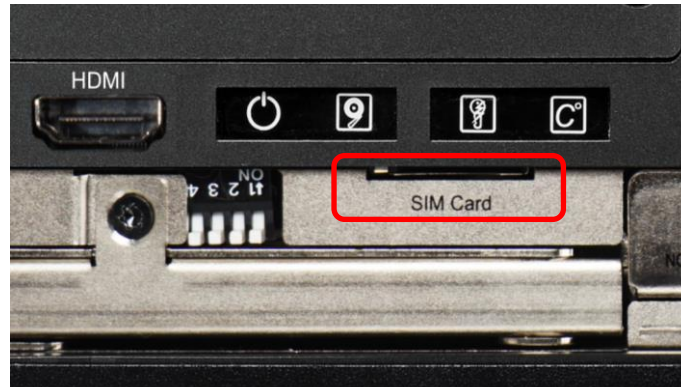

2. Insert a SIM card into SIM slot with the gold contacts facing up. Please pay attention to the insert orientation as illustrated.



3.12 Replacing CMOS Battery

This chapter is only for the situation that is required to replace the CMOS battery.

1. After removing the maintenance cover, locate the removable CMOS Battery and loosen the screw.

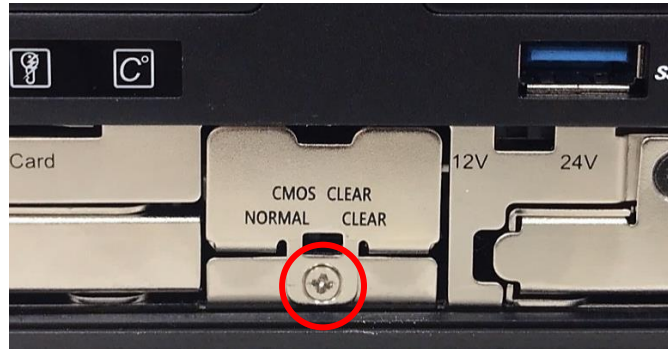

2. Pull out the CMOS battery bracket with assistance of a tweezer.

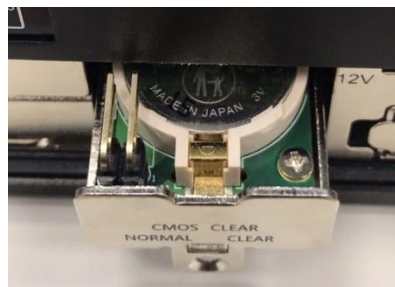

3. Remove the battery by pressing the metal tab backwards slightly as indicated.

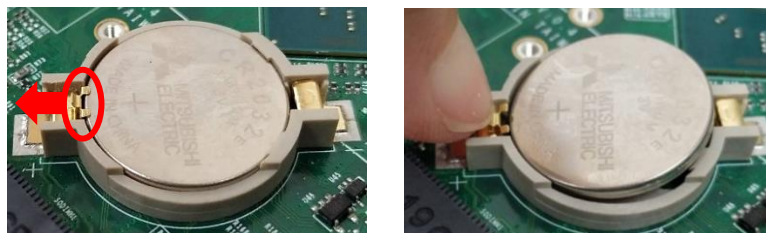

4. Pay attention to the direction of "+" and "-" signs on the battery. Push the battery into the slot from the "-" side and pull the metal tab backwards to make the battery fully installed in the slot.

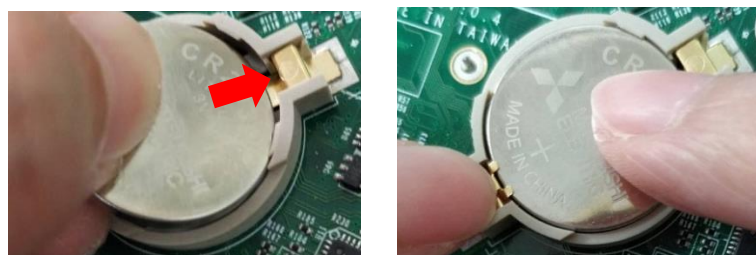

5. Insert the battery bracket firmly and fasten the screw.



3.13 Installing Maintenance Cover

1. Fasten the cover by using the two screws.



NOTE (NOTE)

It's advised to fasten the 2 screws manually. If fastened with an electrical screw driver, please set the torque of the driver to 2.5KgF.

(Il est conseillé de serrer les 2 vis manuellement. S'il est fixé avec un tournevis électrique, veuillez régler le couple du tournevis à 2,5 KgF.)

3.14 Installing Wall Mount

DX-1200 offers wall mount brackets that customers can install system on the wall in convenient and economical ways.

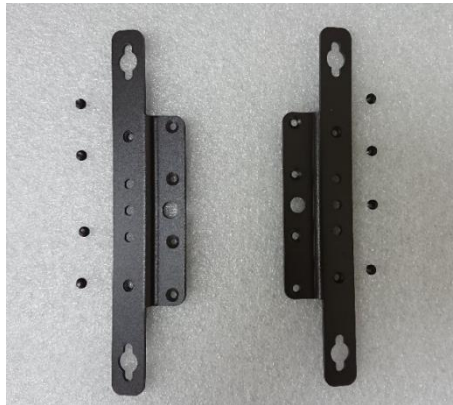

1. The mounting holes are at the bottom side of system. Use provided 8 screws to fasten the bracket on each side.



2. There are 2 bracket mounting holes at left and right side for customer fix the system on the wall.



3.15 Installing VESA Mount

DX-1200 supports VESA mounting that user can mount the system with any panels complying with VESA 75mm or 100 mm standard for various usage. The 75mm VESA uses blue-circle-marked screw holes. The 100mm VESA uses red-circle-marked screw holes.

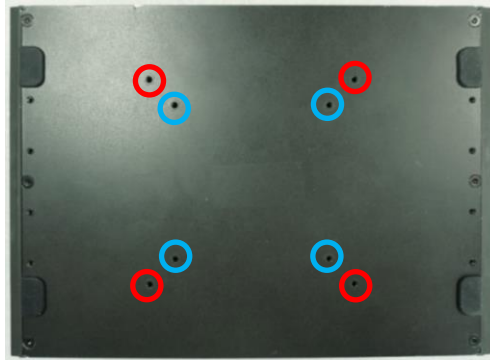



1. Align the screw holes of VESA stand with the screw holes on bottom side of system. Fasten screws to fix it.



2. Provided below is mounted with VESA stand.





Chapter 4

BIOS Setup

4.1 BIOS Introduction

The BIOS (Basic Input/ Output System) is a program located on a Flash Memory on the motherboard. When you start the computer, the BIOS program will gain control. The BIOS first operates an auto-diagnostic test called POST (power on self-test) for all the necessary hardware, it detects the entire hardware device and configures the parameters of the hardware synchronization.

BIOS Setup

Power on the computer and by pressing immediately allows you to enter Setup. If the message disappears before you respond and you still wish to enter Setup, restart the system to try again by turning it OFF then ON or pressing <Ctrl>, <Alt> and <Delete> keys.

Control Keys	
<←> <→>	Move to select screen
<↑> <↓>	Move to select item
<Esc>	Quit the BIOS Setup
<Enter>	Select item
<Page Up/+>	Increases the numeric value or makes changes
<Page Down/->	Decreases the numeric value or makes changes
<Tab>	Select setup fields
<F1>	General help
<F2>	Previous value
<F3>	Load Optimized defaults
<F10>	Save configuration and Exit

Main Menu

The main menu lists the setup functions you can make changes to. You can use the arrow keys (↑↓) to select the item. The on-line description of the highlighted setup function is displayed at the bottom of the screen.

Sub-Menu

If you find a right pointer symbol appears to the left of certain fields that means a sub-menu can be launched from this field. A sub-menu contains additional options for a field parameter. You can use arrow keys (↑↓) to highlight the field and press <Enter> to call up the sub-menu. Then you can use the control keys to enter values and move from field to field within a sub-menu. If you want to return to the main menu, just press the <Esc >.

4.3 Advanced Setup

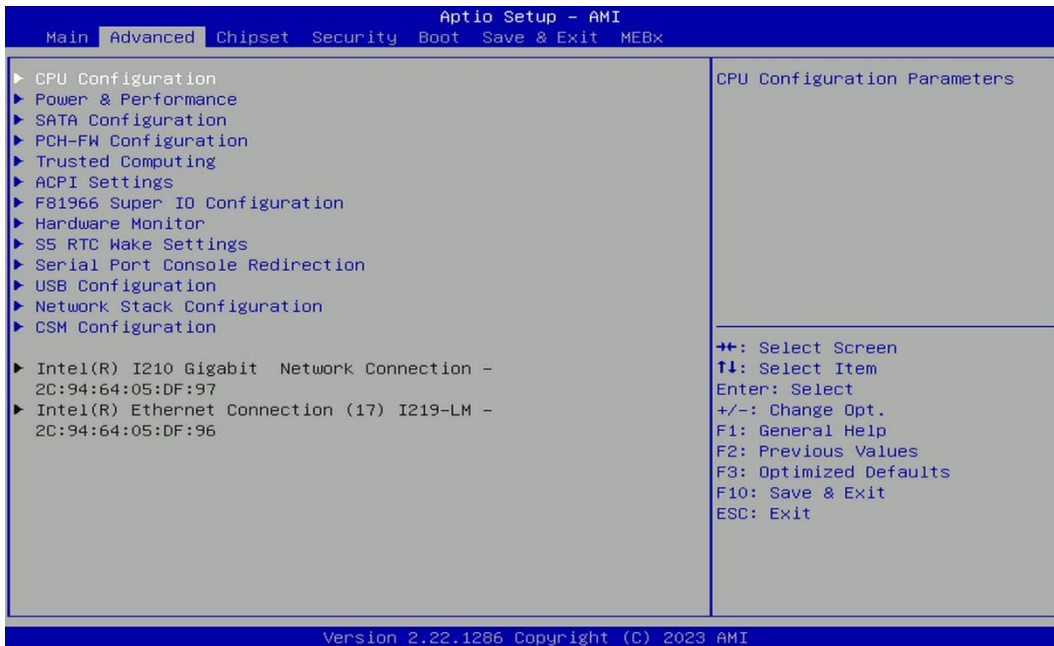

4.3.1 CPU Configuration

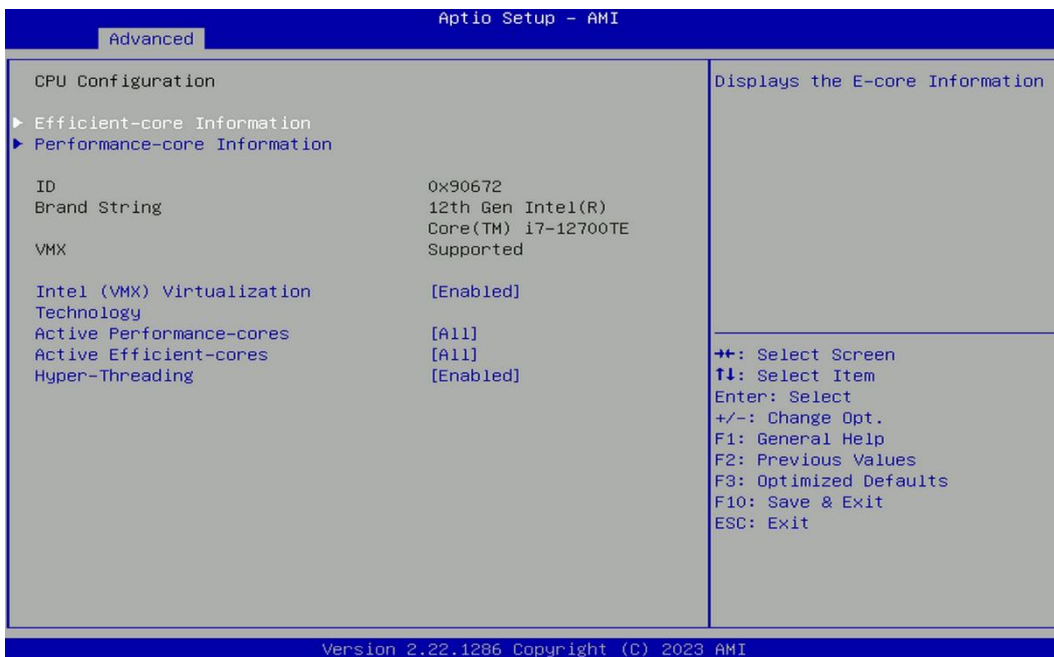

Efficient-core Information

Displays the efficient core Information.

Performance-core Information

Displays the performance core Information.

■ Intel® (VXM) Virtualization Technology

Enables or disables Intel® Virtualization Technology, which will allow a platform to run multiple operating systems and applications in independent partitions. With virtualization, one computer system can function as multiple virtual systems.

■ Active Performance-cores

Allows you to choose the number of active performance cores.

Configuration options: [All] [7] [6] [5] [4] [3] [2] [1].

■ Active Efficient-cores

Allows you to choose the number of active efficient cores.

Configuration options: [All] [3] [2] [1] [0].

■ Hyper-threading

Enables or disables for Hyper-Threading Technology.

4.3.2 Power & Performance



■ SKU Power Config [Auto]

Allows users to choose the upper limit of CPU power.

Configuration options: [Auto] [35W]

4.3.3 SATA And RST Configuration

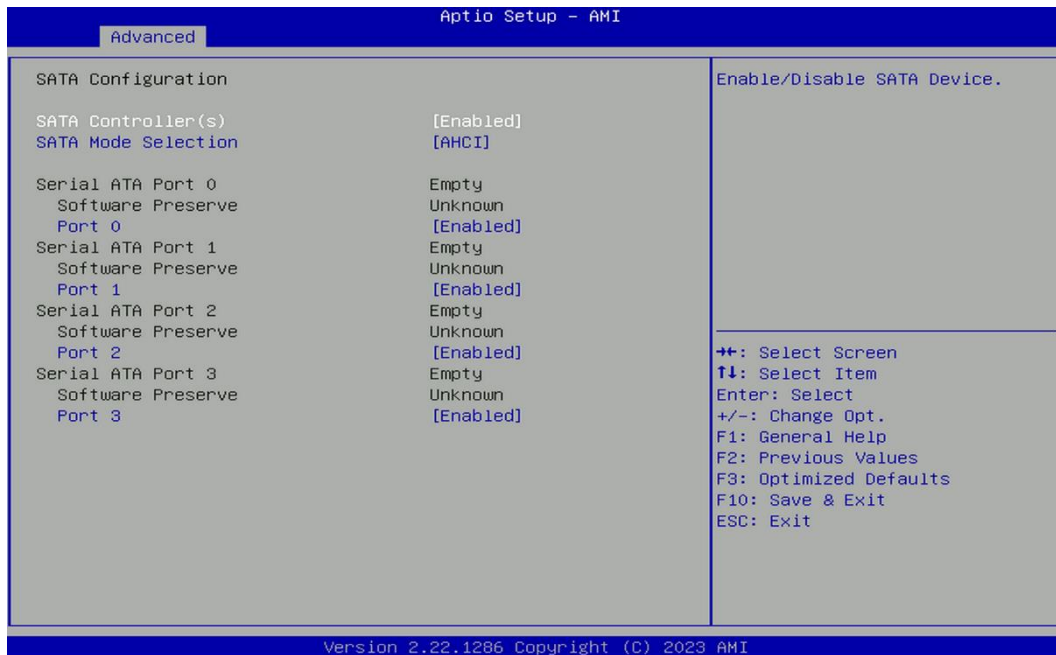

■ SATA Controller(s) [Enabled]

Enables or disables SATA device.

■ SATA Mode Selection [AHCI]

Allows you to select which mode SATA controller will operate.

Configuration options: [AHCI]

Serial ATA Port 0

Port 0 [Enabled]

Enables or disables SATA Port 0.

Serial ATA Port 1

Port 1 [Enabled]

Enables or disables SATA Port 1.

Serial ATA Port 2

Port 2 [Enabled]

Enables or disables SATA Port 2.

Serial ATA Port 3

Port 3 [Enabled]

Enables or disables SATA Port 3.

4.3.4 PCH-FW Configuration



■ Firmware Update Configuration

Configure Management Engine Parameters

Me FW Image Re-Flash

Enables or disables ME firmware Image Re-Flash function.

4.3.5 Trusted Computing Settings

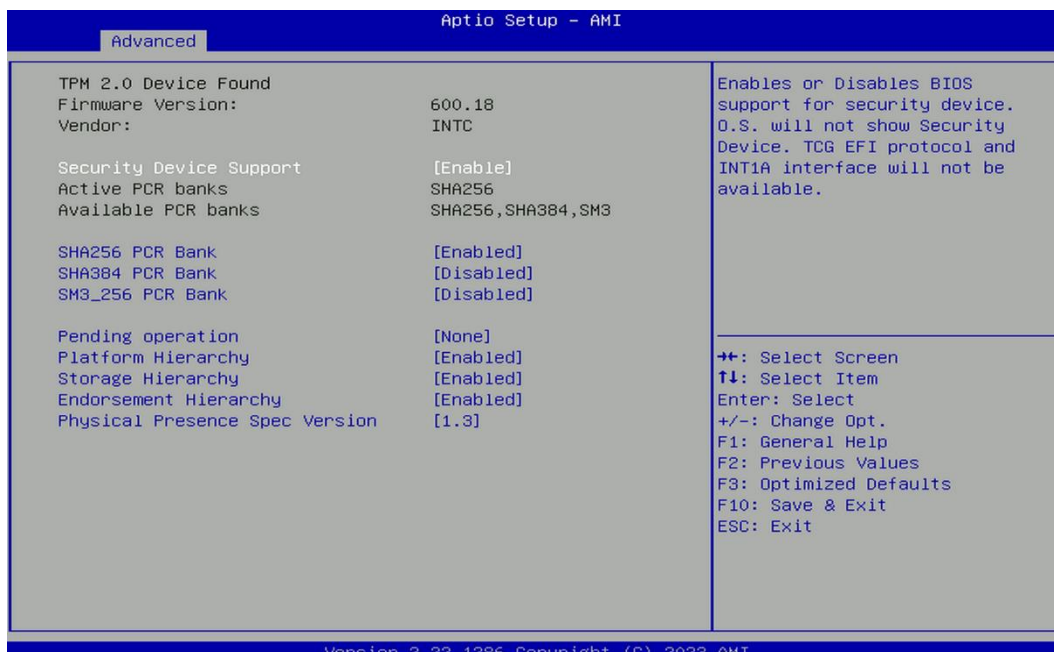

■ Security Device Support [Enabled]

Enables or disables Security Device Support function.

■ SHA256 PCR Bank [Enabled]

Enables or disables SHA256 PCR Bank function.

■ SHA384 PCR Bank [Enabled]

Enables or disables SHA384 PCR Bank function.

■ **SM3_256 PCR Bank [Enabled]**

Enables or disables SM3_256 PCR Bank function.

■ **Pending Operation [None]**

Allows you to select which mode Pending Operation will operate.

Configuration options: [None], [TPM Clear]

■ **Platform Hierarchy [Enabled]**

Enables or disables Platform Hierarchy function.

■ **Storage Hierarchy [Enabled]**

Enables or disables Storage Hierarchy function.

■ **Endorsement Hierarchy [Enabled]**

Enables or disables Endorsement Hierarchy function.

■ **Physical Presence Spec Version [1.3]**

Allows you to select which mode Physical Presence Spec Version will operate.

Configuration options: [1.2], [1.3]

4.3.6 ACPI Settings

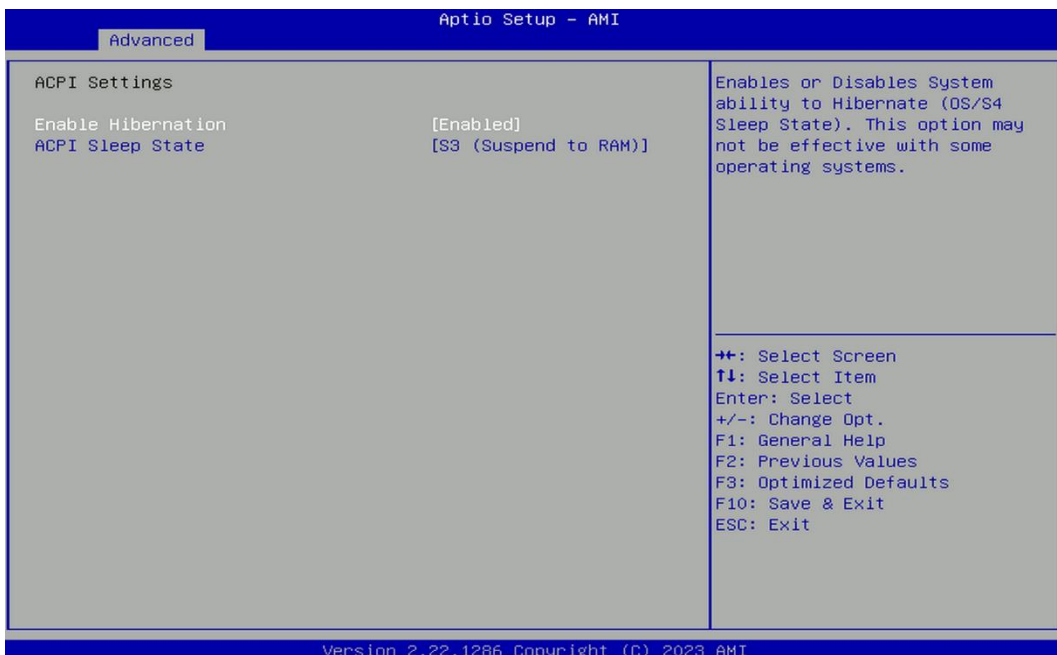

■ **Enable Hibernation [Enabled]**

Enables or disables system ability to hibernate state (OS/S4 state). This option may not be effective with some OS.

■ **ACPI Sleep State [S3 (Suspend to RAM)]**

Allows users to select the highest Advanced Configuration Power Interface® (ACPI) sleep state that system will enter when suspend button is pressed.

[Suspend Disabled]: Disables entering suspend state.

[S3 (suspend to RAM)]: Enables suspend to RAM state.

4.3.7 F81966 Super IO Configuration

Set Parameters of Serial Ports. User can Enable/Disable the serial port and Select an optimal setting for the Super IO Device.

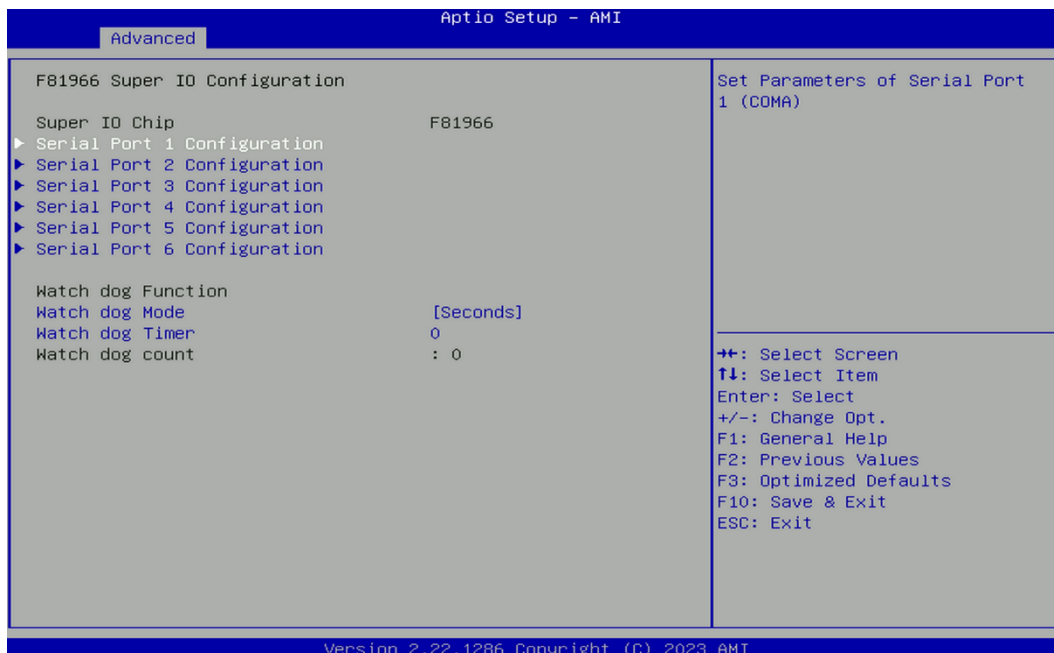

■ Serial Port 1~6 Configuration.



Serial Port [Enabled]

Enables or disables serial port.

Change Settings [Auto]

Allows you to change the IO Address & IRQ settings of the specified serial port.

Onboard Serial Port 1~6 Mode [RS232]

Allows you to select Serial Port Mode.

Configuration options: [RS232] [RS422/RS485 Full Duplex] [RS485 Half Duplex]

■ Watch Dog [Disabled]

Enables or disables watch dog function.

■ Watch Dog Mode [Sec]

Allows to set watchdog timer unit <Sec> or <Min>.

■ Watch Dog Timer [0]

Allows you to set watchdog timer's value in the range of 0 to 255.

4.3.8 Hardware Monitor

This screen displays the current status of all monitored hardware devices/components such as voltages, temperatures and all fans' speeds.

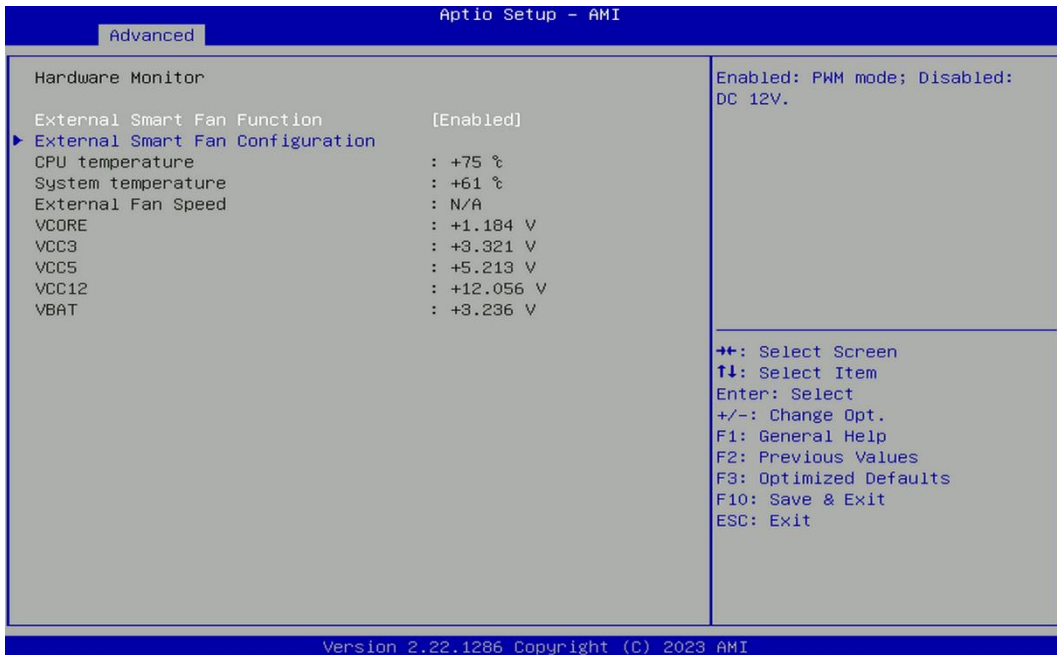

■ External Smart Fan Function [Enabled]

Enables or disables External Smart Fan function.

■ External Smart Fan Configuration [Enabled]

Configure External Smart Fan Parameters.

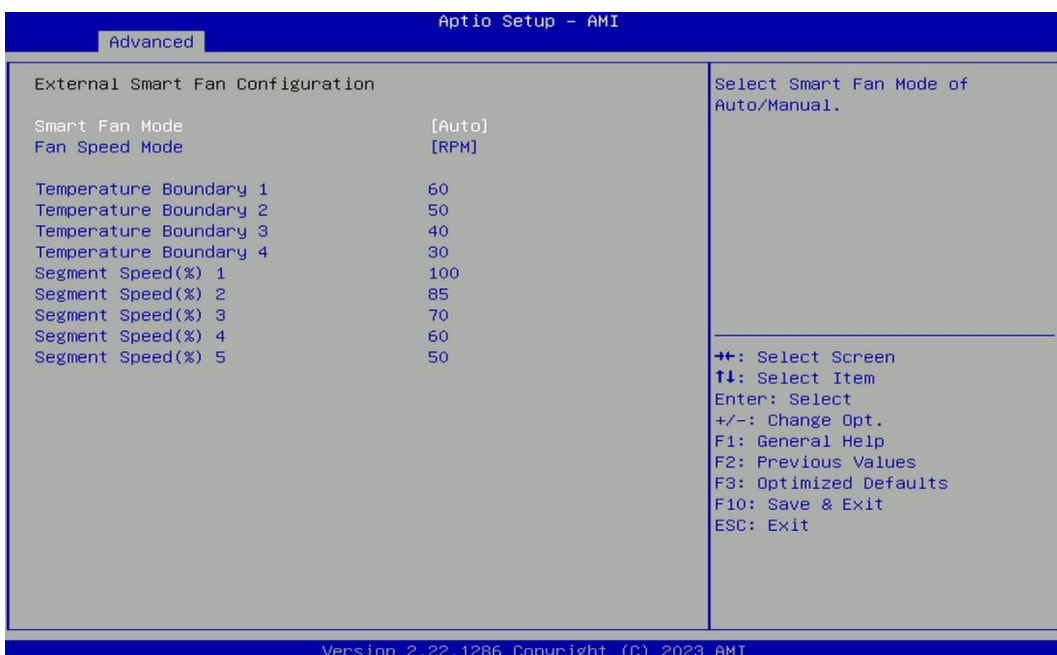

□ Smart Fan Mode [Auto]

Allows you to select Smart Fan Mode.

Configuration options: [Auto] [Manual]

Fan Speed Mode [RPM]

Allows you to select Fan Speed Mode.

Configuration options: [RPM] [Duty]

4.3.9 S5 RTC Wake Settings



■ **Wake system from S5 [Disabled]**

Enables or disables wake system from S5 (soft-off state).

[Disabled]: Disables wake system from S5.

[Fixed Time]: Sets a fixed time (HH:MM:SS) to wake system from S5.

[Dynamic Time]: Sets an increase minute(s) from current time to wake system from S5.

4.3.10 Serial Port Console Redirection

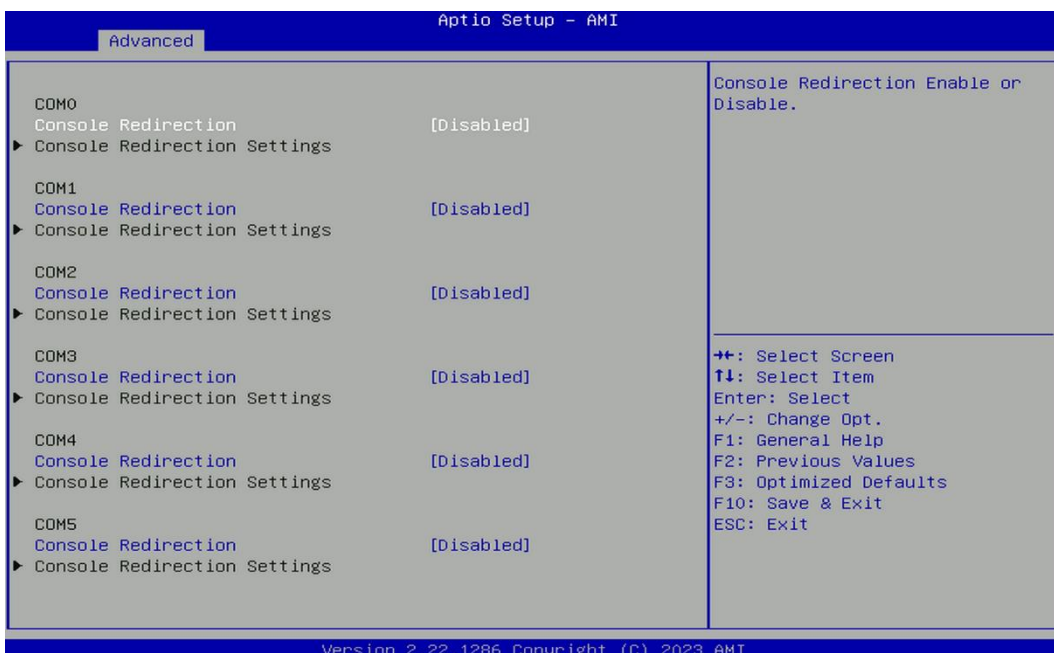

■ Console Redirection

Allow users to enable or disable COM0, COM1, COM2, COM3, COM4, COM5 console redirection function.

COM0 = Serial Port 1

COM1 = Serial Port 2

COM2 = Serial Port 3

COM3 = Serial Port 4

COM4 = Serial Port 5

COM5 = Serial Port 6

4.3.11 USB Configuration

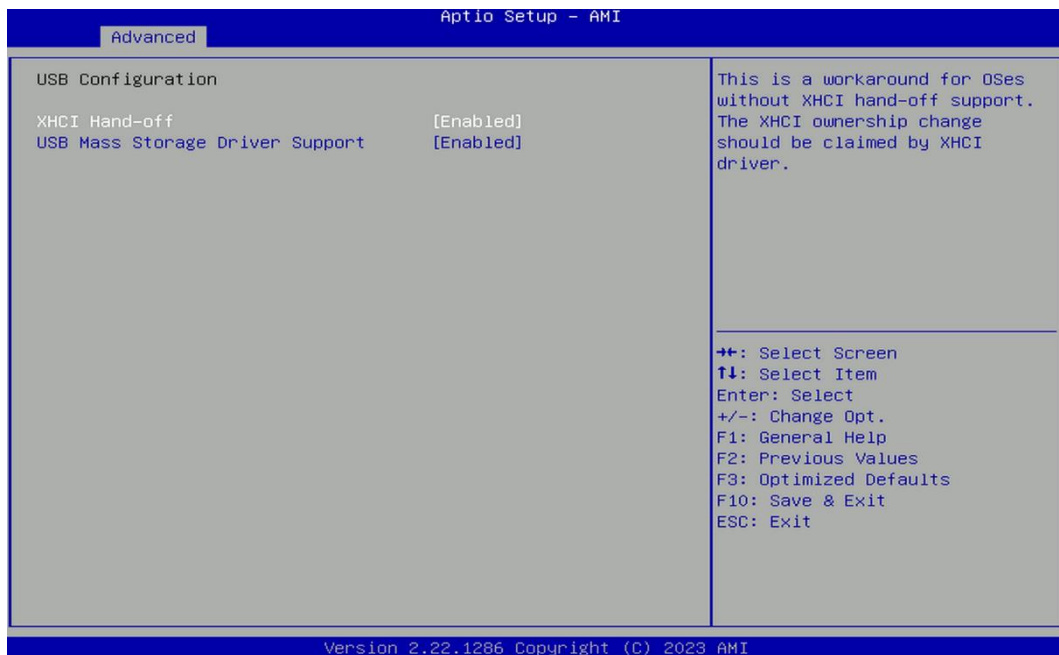

■ XHCI Hand-off [Enabled]

Enables or disables XHCI (USB3.0) hand-off function. Use this feature as a workaround for operating systems without XHCI hand-off support.

■ USB Mass Storage Driver Support [Enabled]

Enables or disables USB mass storage driver support.

4.3.12 Network Stack Configuration

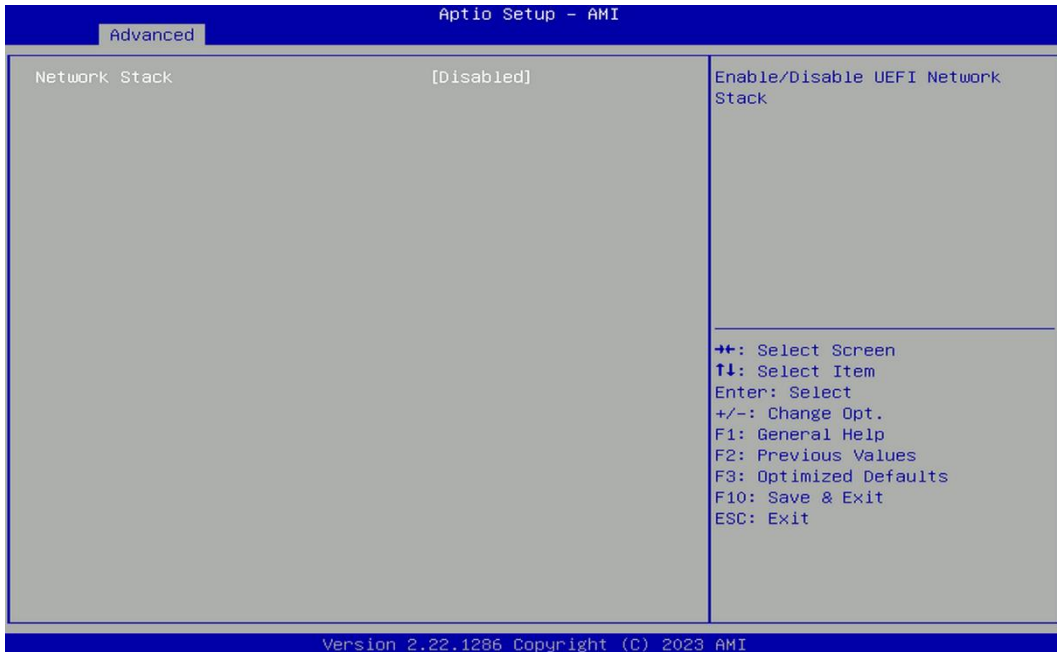

■ Network Stack [Disabled]

Enables or disables UEFI Network Stack.

4.3.13 CSM Configuration



■ CSM Support [Disabled]

Enables or disables compatibility support module.

4.4 Chipset Setup

This section allows you to configure chipset related settings according to user's preference.

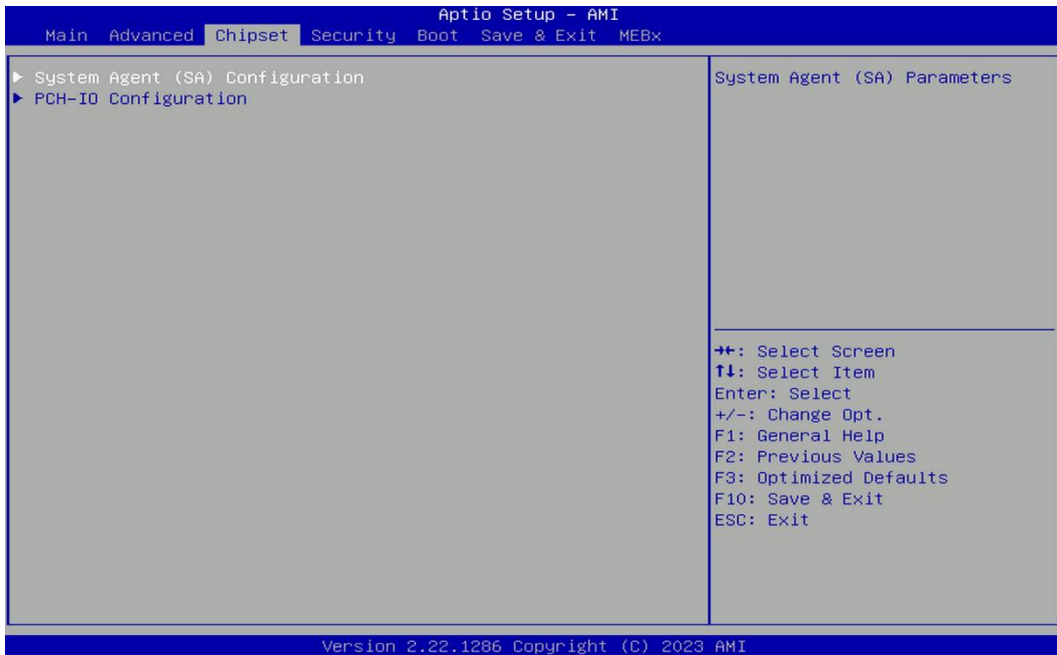

4.4.1 System Agent (SA) Configuration

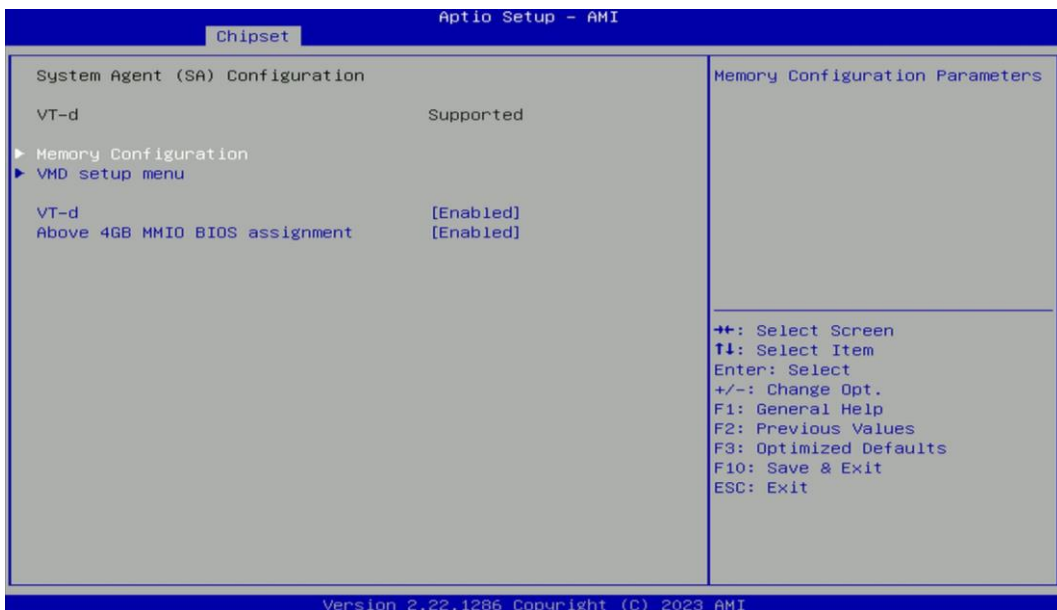

Memory Configuration

This item displays detailed memory configuration in the system.

❑ VMD Configuration

❑ Enable VMD Controller [Disabled]

Allows users to enable or disable VMD Controller.

Configuration options: [Disabled] [Enabled]

Enable this function can support creating RAID.

■ VT-d [Enabled]

Enables or disables Intel® Virtualization Technology for Directed I/O (VT-d) capability.

■ Above 4GB MMIO BIOS assignment [Enabled]

Enables or disables Above 4GB MMIO BIOS assignment.

4.4.2 PCH-IO Configuration

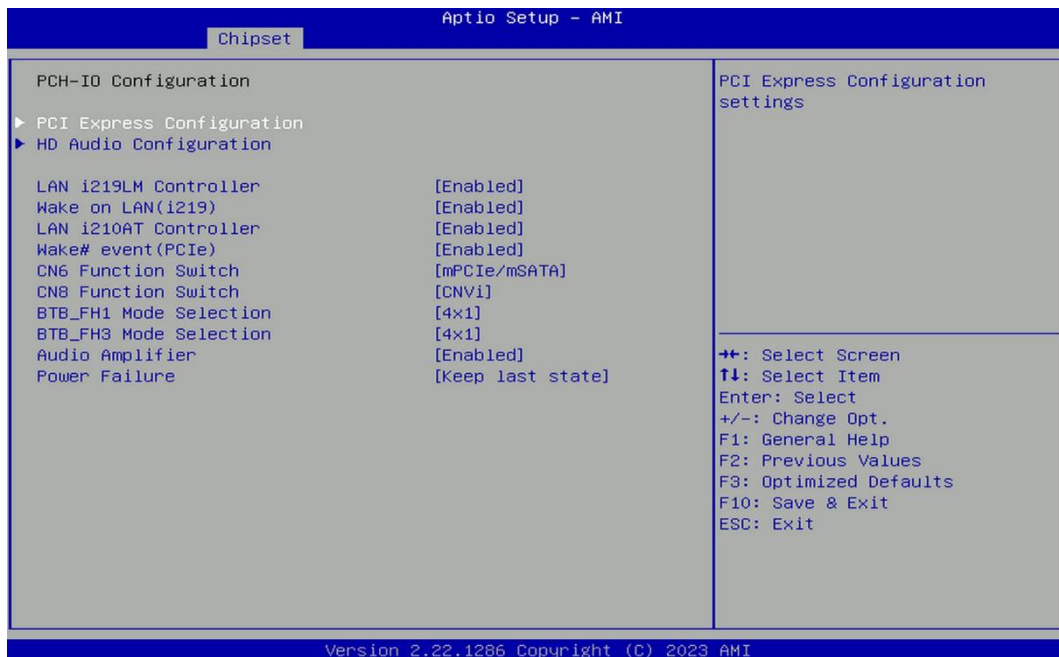

■ PCI Express Configuration

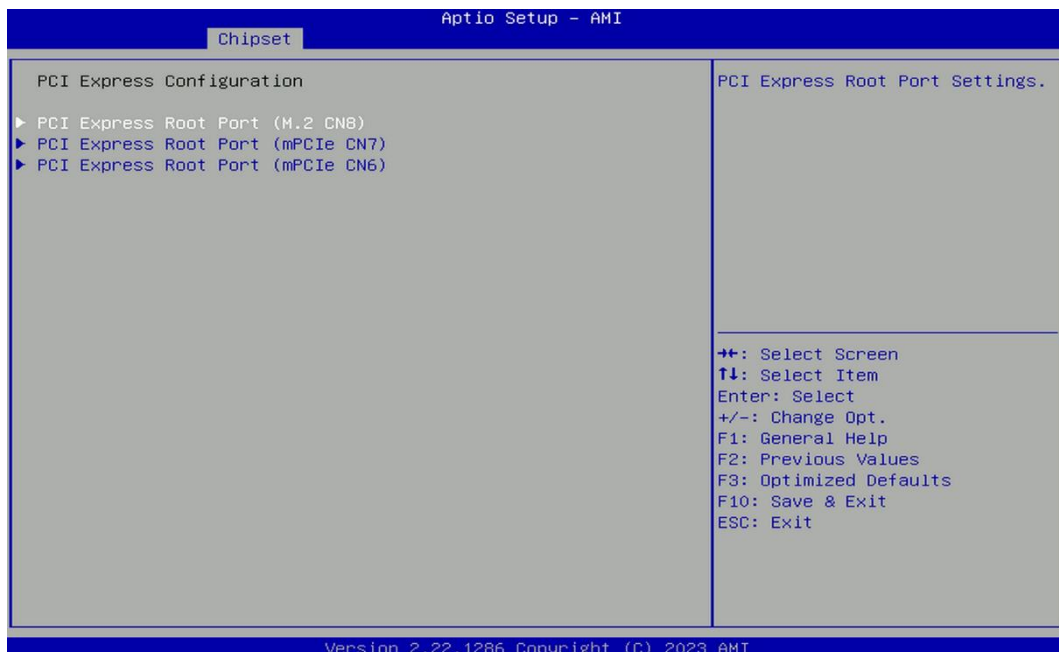

- PCI Express Root Port (M.2 CN8)**
 - PCI Express Root Port [Enabled]**
 Enables or disables PCI Express Root Port.
 - PCIe Speed [Auto]**
 Allows you to select PCI Express interface speed.
 Configuration options: [Auto] [Gen1] [Gen2] [Gen3].
- PCI Express Root Port (mPCIe CN7)**
 - PCI Express Root Port [Enabled]**
 Enables or disables PCI Express Root Port.
 - PCIe Speed [Auto]**
 Allows you to select PCI Express interface speed.
 Configuration options: [Auto] [Gen1] [Gen2] [Gen3].
- PCI Express Root Port (mPCIe CN6)**
 - PCI Express Root Port [Enabled]**
 Enables or disables PCI Express Root Port.
 - PCIe Speed [Auto]**
 Allows you to select PCI Express interface speed.
 Configuration options: [Auto] [Gen1] [Gen2] [Gen3].
- HD Audio Configuration**
 - HD Audio [Enabled]**
 Enables or disables HD Audio.
- LAN i219LM Controller [Enabled]**
 Enables or disables I219-LM LAN Controller.
- Wake on LAN (i219) [Enabled]**
 Enables or disables integrated LAN i219 Wake on LAN function.
- LAN i210AT Controller [Enabled]**
 Enables or disables I210 LAN Controller.
- Wake# event (PCIe) [Enabled]**
 Enables or disables integrated LAN i210 Wake on LAN function.
- CN6 Function Switch [mPCIe/mSATA]**
 Allows you to change CN6 as [mPCIe/mSATA] or [USB3.0].
- CN8 Function Switch [CNVi]**
 Allows you to change CN8 as [CNVi] or [WiFi].
- BTB_FH1 Mode Selection [4x1]**
 Allows users to select [4x1] or [1x4] for BTB_FH1 Mode.
- BTB_FH3 Mode Selection [4x1]**
 Allows users to select [4x1] or [1x4] for BTB_FH3 Mode.
- Audio Amplifier [Enabled]**
 Enables or disables Audio Amplifier Function.
- Power Failure [Keep last state]**

Allows you to specify which power state system will enter when power is resumed after a power failure (G3 state).

[Always on]: Enters to power on state.

[Always off]: Enters to power off state.

[Keep last state]: Enters to the last power state before a power failure.

4.5 Security Setup

This section allows users to configure BIOS security settings.

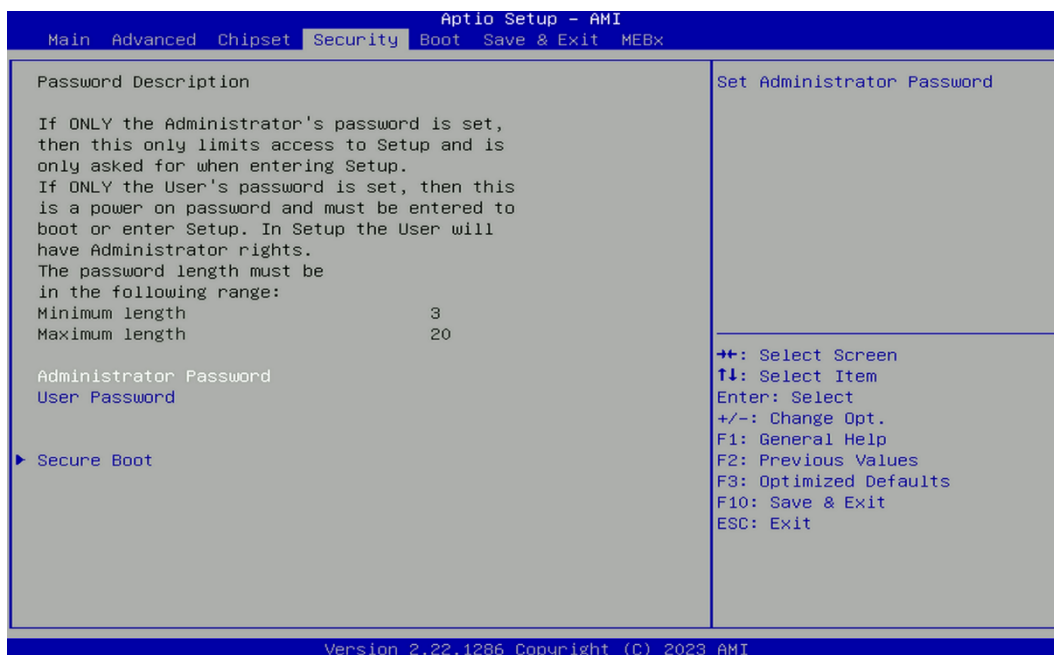

■ Administrator Password

Administrator Password controls access to the BIOS Setup utility.

■ User Password

User Password controls access to the system at boot and to the BIOS Setup utility.

■ Security Boot

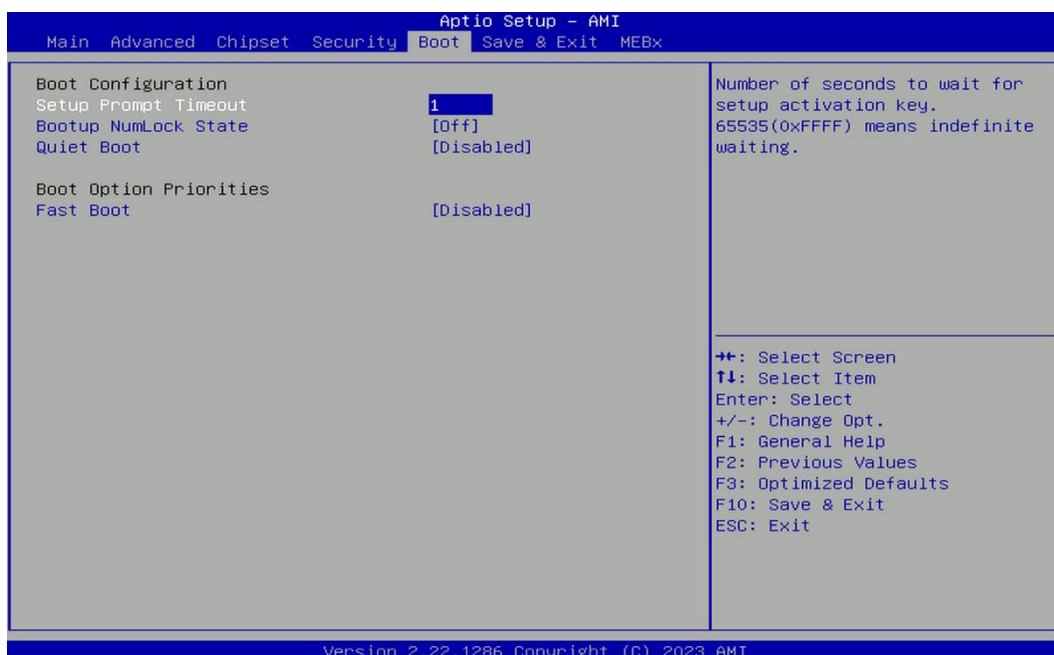

- ❑ **Secure Boot [Disabled]**
Enable or disable Secure Boot function.
- ❑ **Secure Boot Mode [Standard]**
Allows you to select Secure Boot Mode.
Configuration options: [Standard] [Custom].

4.6 Boot Setup

This section allows you to configure Boot settings.

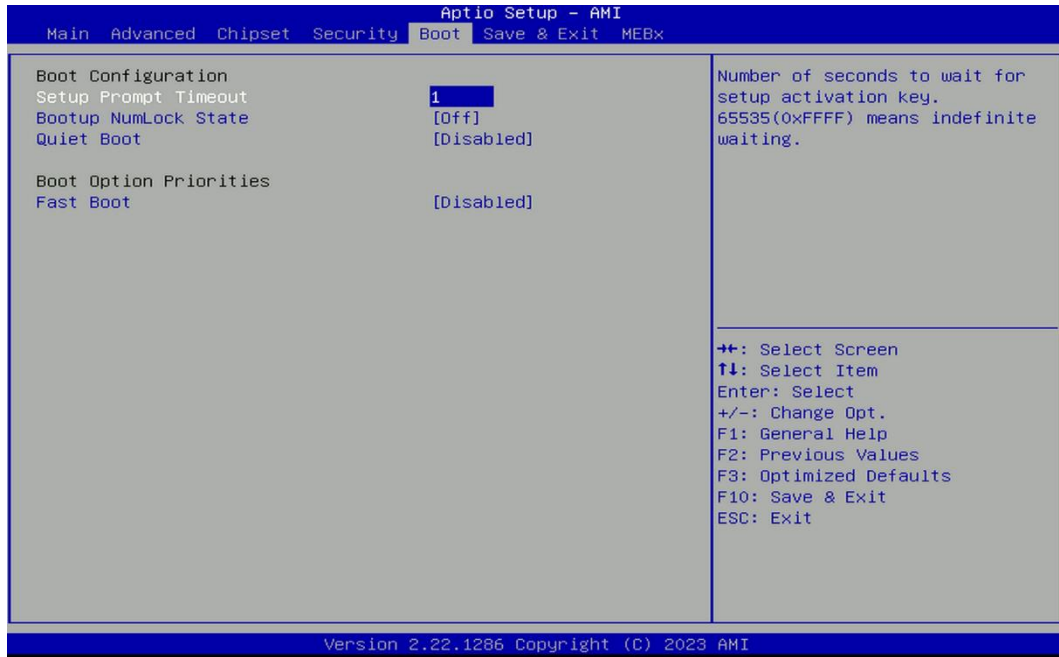

■ Setup Prompt Timeout

Use this item to set number of seconds (1..65535) to wait for setup activation key.

■ Bootup NumLock State

Allows you to set NumLock key to [On] or [Off] state when system boots up.

■ Quiet Boot

Allows you to enable or disable Quiet Boot function.

■ Fast Boot

Allows you to enable or disable Fast Boot function. If enabled, system boots with initialization of a minimal set of devices required to launch active boot option.

4.7 Save & Exit



■ Save Changes and Exit

This item allows you to exit system setup after saving changes.

■ Discard Changes and Exit

This item allows you to exit system setup without saving changes.

■ Save Changes and Reset

This item allows you to reset the system after saving changes.

■ Discard Changes and Reset

This item allows you to reset system setup without saving any changes.

■ Save Changes

This item allows you to save changes done so far to any of the setup options.

■ Discard Changes.

This item allows you to discard changes done so far to any of the setup options.

■ Restore Defaults

This item allows you to restore/ load default values for all the setup options.

■ Save as User Defaults

This item allows you to save the changes done so far as user defaults.

■ Restore User Defaults

This item allows you to restore the user defaults to all the setup options.

4.8 MEBx

This page is for ME function setting. Press the delete key to enter the BIOS menu then user can see the following MEBx page.

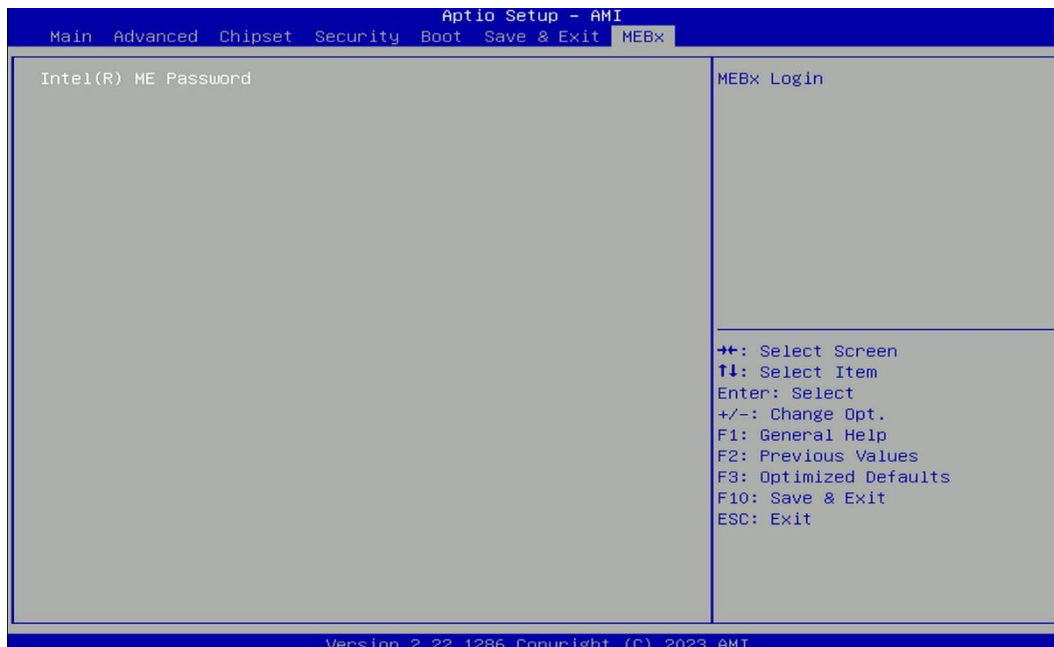

Press enter key to enter the default password "admin" to enter the next step for password creation.

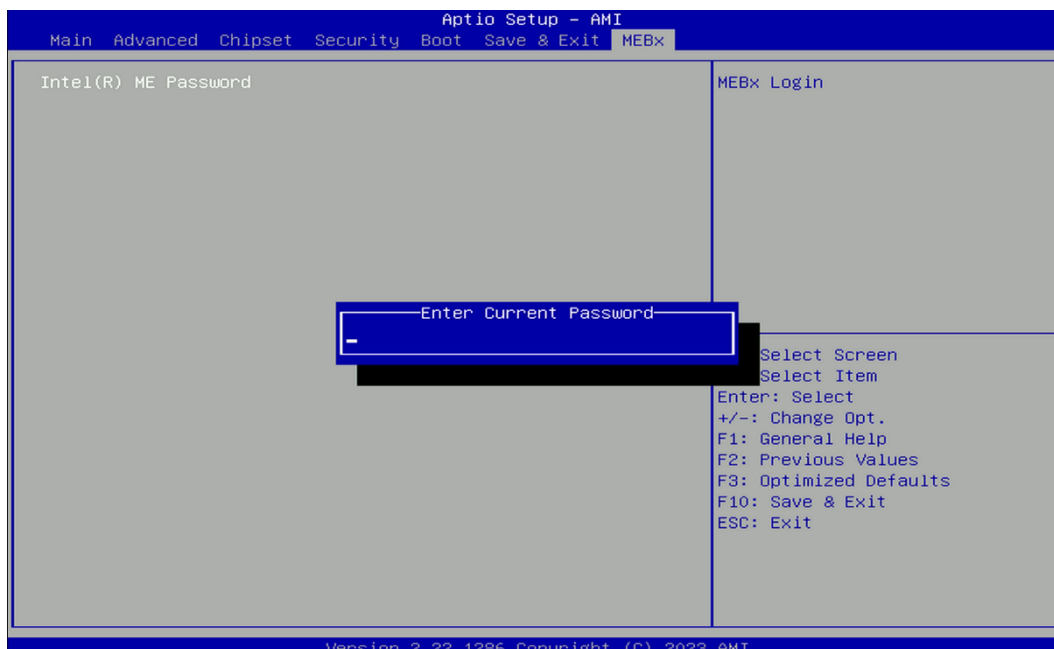

Create a new password using 8 characters including uppercase and lowercase letters, numbers and special symbols.

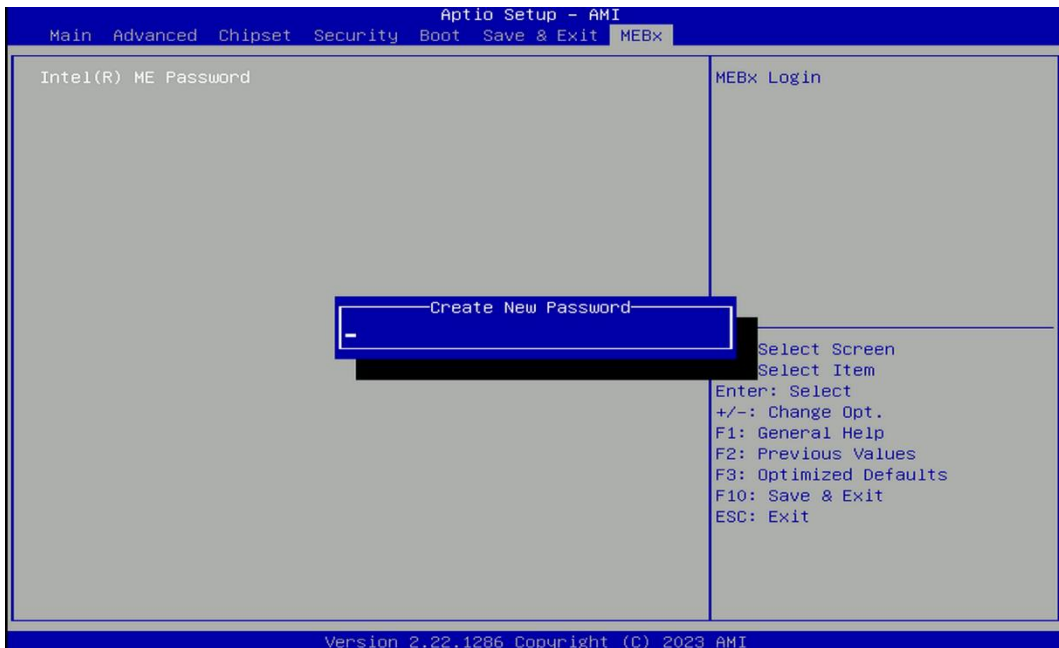

Enter the created password again for confirmation.

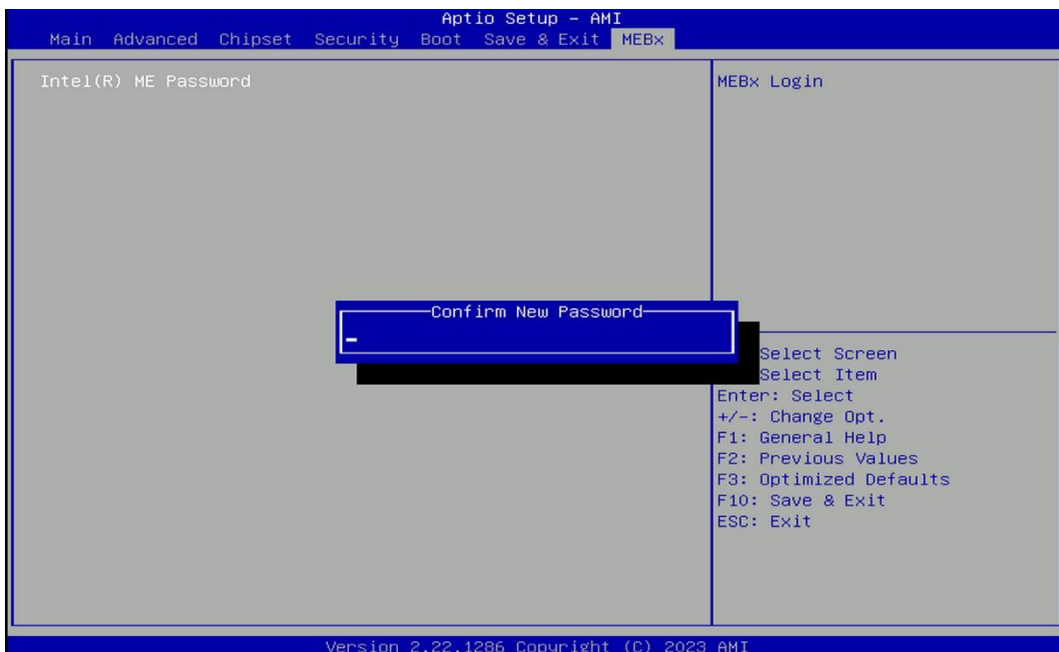

Then you can see the function setting page of MEBx.

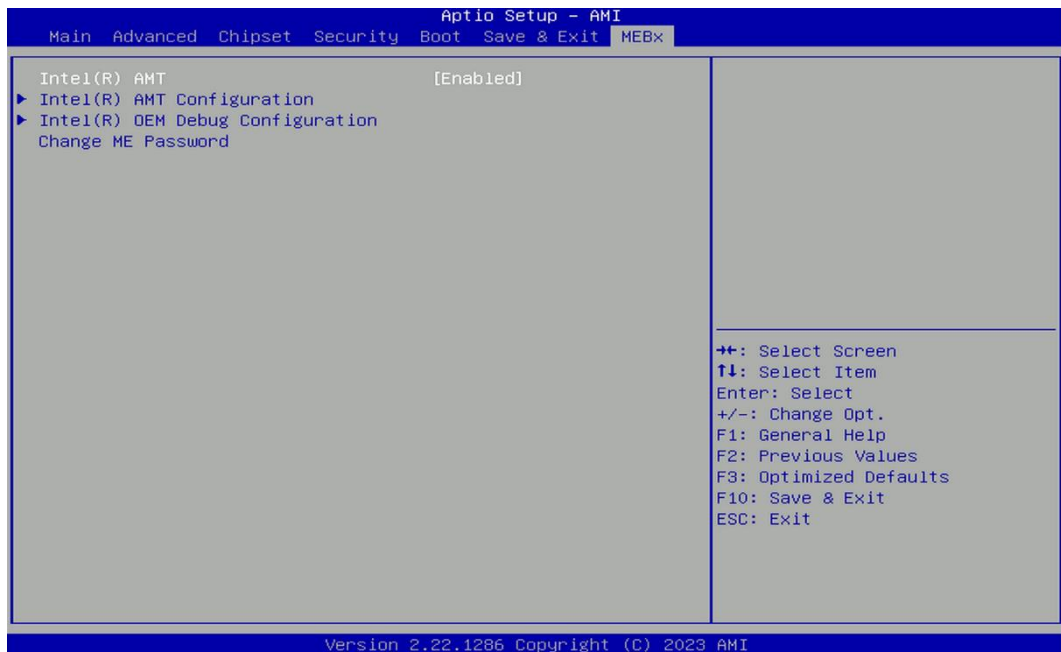



Chapter 5

Product Application

5.1 Digital I/O (DIO) application

This section describes GPIO LED application of the product. The content and application development are better understood and implemented by well experienced professionals or developers.

5.1.1 Digital I/O Programming Guide

5.1.1.1 Pins for Digital I/O

Item	Standard
GPIO 70(PIN 103)	DI
GPIO 71(PIN 104)	
GPIO 72(PIN 105)	
GPIO 73(PIN 106)	
GPIO 74(PIN 107)	
GPIO 75(PIN 108)	
GPIO 76(PIN 109)	
GPIO 77(PIN 110)	
GPIO 80(PIN 111)	DO
GPIO 81(PIN 112)	
GPIO 82(PIN 113)	
GPIO 83(PIN 114)	
GPIO 84(PIN 115)	
GPIO 85(PIN 116)	
GPIO 86(PIN 117)	
GPIO 87(PIN 118)	

5.1.1.2 Programming Guide

To program the Super I/O chip **F81966D** configuration registers, the following configuration procedures must be followed in sequence:

- (1) Enter the Extended Function Mode
- (2) Configure the configuration registers
- (3) Exit the Extended Function Mode

The configuration register is used to control the behavior of the corresponding devices. To configure the register, using the index port to select the index and then writing data port to alter the parameters. The default index port and data port are 0x4E and 0x4F respectively.

To enable configuration, the entry key 0x87 must be written to the index port. To disable configuration, write exit key 0xAA to the index port.

Following is an example to enable configuration and to disable configuration by using debug.

- o 4e 87
- o 4e 87 (enable configuration)
- o 4e aa (disable configuration)

5.1.1.3 Relative Registers

To program the **F81966D** configuration registers, see the following configuration procedures.

Logic Device Number Register (LDN) — Index 07h					
Bit	Name	R/W	Reset	Default	Description
7-0	LDN	R/W	LRESET#	00h	03h: Select Parallel Port device configuration registers. 04h: Select Hardware Monitor device configuration registers. 05h: Select KBC device configuration registers. 06h: Select GPIO device configuration registers. 07h: Select WDT device configuration registers. 0Ah: Select PME, ACPI and ERP device configuration registers. 0Fh: Select SPI device configuration registers. 10h: Select UART1 device configuration registers. 11h: Select UART2 device configuration registers. 12h: Select UART3 device configuration registers. 13h: Select UART4 device configuration registers. 14h: Select UART5 device configuration registers. 15h: Select UART6 device configuration registers. Otherwise: Reserved.

GPIO7x Output Enable Register — Index 80h

Bit	Name	R/W	Reset	Default	Description
7	GPIO77_OE	R/W	3VCC	0	0: GPIO77 is in input mode. 1: GPIO77 is in output mode.
6	GPIO76_OE	R/W	3VCC	0	0: GPIO76 is in input mode. 1: GPIO75 is in output mode.
5	GPIO75_OE	R/W	3VCC	0	0: GPIO75 is in input mode. 1: GPIO75 is in output mode.
4	GPIO74_OE	R/W	3VCC	0	0: GPIO74 is in input mode. 1: GPIO74 is in output mode.
3	GPIO73_OE	R/W	3VCC	0	0: GPIO73 is in input mode. 1: GPIO73 is in output mode.
2	GPIO72_OE	R/W	3VCC	0	0: GPIO72 is in input mode. 1: GPIO72 is in output mode.
1	GPIO71_OE	R/W	3VCC	0	0: GPIO71 is in input mode. 1: GPIO71 is in output mode.
0	GPIO70_OE	R/W	3VCC	0	0: GPIO70 is in input mode. 1: GPIO70 is in output mode.

GPIO7x Pin Status Register — Index 82h (This byte could be also read by base address + 3)

Bit	Name	R/W	Reset	Default	Description
7	GPIO77_ST	R	-	-	The pin status of GPIO77.
6	GPIO76_ST	R	-	-	The pin status of GPIO76.
5	GPIO75_ST	R	-	-	The pin status of GPIO75.
4	GPIO74_ST	R	-	-	The pin status of GPIO74.
3	GPIO73_ST	R	-	-	The pin status of GPIO73.
2	GPIO72_ST	R	-	-	The pin status of GPIO72.
1	GPIO71_ST	R	-	-	The pin status of GPIO71.
0	GPIO70_ST	R	-	-	The pin status of GPIO70.

GPIO8x Output Enable Register — Index 88h

Bit	Name	R/W	Reset	Default	Description
7	GPIO87_OE	R/W	3VCC	0	0: GPIO87 is in input mode. 1: GPIO87 is in output mode.
6	GPIO86_OE	R/W	3VCC	0	0: GPIO86 is in input mode. 1: GPIO85 is in output mode.
5	GPIO85_OE	R/W	3VCC	0	0: GPIO85 is in input mode. 1: GPIO85 is in output mode.
4	GPIO84_OE	R/W	3VCC	0	0: GPIO84 is in input mode. 1: GPIO84 is in output mode.
3	GPIO83_OE	R/W	3VCC	0	0: GPIO83 is in input mode. 1: GPIO83 is in output mode.
2	GPIO82_OE	R/W	3VCC	0	0: GPIO82 is in input mode. 1: GPIO82 is in output mode.
1	GPIO81_OE	R/W	3VCC	0	0: GPIO81 is in input mode. 1: GPIO81 is in output mode.
0	GPIO80_OE	R/W	3VCC	0	0: GPIO80 is in input mode. 1: GPIO80 is in output mode.

GPIO8x Output Data Register — Index 89h (This byte could be also written by base address + 2)

Bit	Name	R/W	Reset	Default	Description
7	GPIO87_DATA	R/W	3VCC	1	0: GPIO87 outputs 0 when in output mode. 1: GPIO87 outputs 1 when in output mode.
6	GPIO86_DATA	R/W	3VCC	1	0: GPIO86 outputs 0 when in output mode. 1: GPIO86 outputs 1 when in output mode.
5	GPIO85_DATA	R/W	3VCC	1	0: GPIO85 outputs 0 when in output mode. 1: GPIO85 outputs 1 when in output mode.
4	GPIO84_DATA	R/W	3VCC	1	0: GPIO84 outputs 0 when in output mode. 1: GPIO84 outputs 1 when in output mode.
3	GPIO83_DATA	R/W	3VCC	1	0: GPIO83 outputs 0 when in output mode. 1: GPIO83 outputs 1 when in output mode.
2	GPIO82_DATA	R/W	3VCC	1	0: GPIO82 outputs 0 when in output mode. 1: GPIO82 outputs 1 when in output mode.
1	GPIO81_DATA	R/W	3VCC	1	0: GPIO81 outputs 0 when in output mode. 1: GPIO81 outputs 1 when in output mode.
0	GPIO80_DATA	R/W	3VCC	1	0: GPIO80 outputs 0 when in output mode. 1: GPIO80 outputs 1 when in output mode.

Information about GPIO access ways & Base Address

4.4.1 GPIO Access Method

There are nine sets of GPIO which can be accessed by three ways as below:

1. Configuration register port: Use 0x4E/0x4F (or 0x2E/0x2F) port with logic device number 0x06. Please refer to configuration register for detail.
2. Index/Data port: The index port is base address + 0 and data port is base address + 1. To access the GPIO register, user should first write index to index port and then read/write from/to data port. The index for each register is same as the definition in configuration register.
3. Digital I/O: This way could access GPIO data register only. It is used for quickly control the GPIO pins. The register for each address is as below table:

GPIO Digital I/O Registers									
Offset	Register Name	Default Value							
		MSB				LSB			
0h	Index Port	1	1	1	1	1	1	1	1
1h	Data Port	-	-	-	-	-	-	-	-
2h	GPIO8 Data Port	-	-	-	-	-	-	-	-
3h	GPIO7 Data Port	-	-	-	-	-	-	-	-
4h	GPIO6 Data Port	-	-	-	-	-	-	-	-
5h	GPIO5 Data Port	-	-	-	-	-	-	-	-
6h	GPIO0 Data Port	-	-	-	-	-	-	-	-
7h	GPIO1 Data Port	-	-	-	-	-	-	-	-
8h*	GPIO2 Data Port	-	-	-	-	-	-	-	-
9h*	GPIO3 Data Port	-	-	-	-	-	-	-	-
Ah*	GPIO4 Data Port	-	-	-	-	-	-	-	-
Bh*	GPIO9 Data Port	-	-	-	-	-	-	-	-
E-Fh*	Reserved	-	-	-	-	-	-	-	-

*Available when GPIO_DEC_RANGE is set "1" (Configuration register index 0x27, bit 5)

5.6.1 GPIO General Register

“-” Reserved or Tri-State

Register 0x[HEX]	Register Name	Default Value							
		MSB				LSB			
30	GPIO Device Enable Register	-	-	-	-	-	-	-	0
60	Base Address High Register	0	0	0	0	0	0	0	0
61	Base Address Low Register	0	0	0	0	0	0	0	0
70	GPIO0x IRQ Channel Select Register	-	-	-	-	0	0	0	0
71	GPIO1x IRQ Channel Select Register	-	-	-	-	0	0	0	0
72	GPIO5x IRQ Channel Select Register	-	-	-	-	0	0	0	0
73	GPIO8x IRQ Channel Select Register	-	-	-	-	0	0	0	0
7E	GPIO0x/1x/5x/8x IRQ Share Register	-	-	-	-	0	0	0	0
7F	GPIO0x/1x/5x/8x IRQ Mode Register	0	0	0	0	0	0	0	0

5.6.2 GPIO Device Enable Register — Index 30h

Bit	Name	R/W	Reset	Default	Description
7-1	Reserved	-	-	-	Reserved
0	GPIO_EN	R/W	LRESET#	0	0: disable GPIO I/O port. 1: enable GPIO I/O port.

5.6.3 Base Address High Register — Index 60h

Bit	Name	R/W	Reset	Default	Description
7-0	BASE_ADDR_H	R/W	LRESET#	0h	The MSB of GPIO I/O port address.

5.6.4 Base Address Low Register — Index 61h

Bit	Name	R/W	Reset	Default	Description
7-0	BASE_ADDR_LO	R/W	LRESET#	0h	The LSB of GPIO base address.

5.1.1.4 Sample Code in C Language

5.1.1.4.1 Control of GP70 to GP77 (DI1~DI8)

```
#define AddrPort 0x4E
```

```
#define DataPort 0x4F
```

<Enter the Extended Function Mode>

```
WriteByte(AddrPort, 0x87)
WriteByte(AddrPort, 0x87) // Must write twice to enter Extended mode
```

<Select Logic Device>

```
WriteByte(AddrPort, 0x07)
WriteByte(dataPort, 0x06) // Select logic device 06h
```

<Output/Input Mode Selection> // Set GP70 to GP77 input Mode

```
WriteByte(AddrPort, 0x80) // Select configuration register 80h
WriteByte(DataPort, 0x00) // Set bit(0~7) = 0 ,thus select GP 70~77 as Input mode.
```

<Input Value>

```
WriteByte(AddrPort, 0x82) // Select configuration register 82h (for GP70~77)
ReadByte(DataPort, Value) // If read bit(0~7) = 0xFF, thus GP70~77 is all High.
// If read bit(0~7) = x00, thus GP70~77 is all Low.
```

<Leave the Extended Function Mode>

```
WriteByte(AddrPort, 0xAA)
```

5.1.1.4.2 Control of GP80 to GP87 (DO1~DO8)

```
#define AddrPort 0x4E
```

```
#define DataPort 0x4F
```

<Enter the Extended Function Mode>

```
WriteByte(AddrPort, 0x87)
WriteByte(AddrPort, 0x87) // Must write twice to enter Extended mode
```

<Select Logic Device>

```
WriteByte(AddrPort, 0x07)
WriteByte(DataPort, 0x06) // Select logic device 06h
```

<Output/Input Mode Selection> // Set GP80 to GP87 output Mode

```
WriteByte(AddrPort, 0x88) // Select configuration register 88h
WriteByte(DataPort, 0xFF) // Set bit(0~7) = 1 ,thus select GP 80~87 as Output mode
```

<Output Value>

```
WriteByte(AddrPort, 0x89) // Select configuration register 89h
WriteByte(DataPort, Value) // Set bit(0~7) = (0/1) to output GP 80~87 as Low or High
```

<Leave the Extended Function Mode>

```
WriteByte(AddrPort, 0xAA)
```

5.1.1.5 Change base address

<Enter the Extended Function Mode>

```
WriteByte(AddrPort, 0x87)
```

```
WriteByte(AddrPort, 0x87) // Must write twice to enter Extended mode
```

<Select Logic Device>

```
WriteByte(AddrPort, 0x07)
```

```
WriteByte(dataPort, 0x06) // Select logic device 06h
```

```
WriteByte(AddrPort, 0x60) // Select configuration register 60h (High Byte address)
```

```
WriteByte(DataPort, (0x0A))
```

```
WriteByte(AddrPort, 0x61) // Select configuration register 61h (Low Byte address)
```

```
WriteByte(DataPort, (0x00))
```

<Leave the Extended Function Mode>

```
WriteByte(AddrPort, 0xAA)
```

Cincoze default GPIO Port base address is 0xA00h

5.1.1.6 DATA Bit Table (DIO)

<table border="1"> <tr><td>7</td><td>6</td><td>5</td><td>4</td><td>3</td><td>2</td><td>1</td><td>0</td><td>bit</td></tr> <tr><td>0</td><td>0</td><td>0</td><td>0</td><td>0</td><td>0</td><td>0</td><td>1</td><td>Value</td></tr> <tr><td colspan="8">1</td><td>/h</td></tr> </table>	7	6	5	4	3	2	1	0	bit	0	0	0	0	0	0	0	1	Value	1								/h	<p>= DI1 (Base address +3) (0xA03)</p>	<table border="1"> <tr><td>7</td><td>6</td><td>5</td><td>4</td><td>3</td><td>2</td><td>1</td><td>0</td><td>bit</td></tr> <tr><td>0</td><td>0</td><td>0</td><td>0</td><td>0</td><td>0</td><td>0</td><td>1</td><td>Value</td></tr> <tr><td colspan="8">1</td><td>/h</td></tr> </table>	7	6	5	4	3	2	1	0	bit	0	0	0	0	0	0	0	1	Value	1								/h	<p>= DO1 (Base address +2) (0xA02)</p>
7	6	5	4	3	2	1	0	bit																																																	
0	0	0	0	0	0	0	1	Value																																																	
1								/h																																																	
7	6	5	4	3	2	1	0	bit																																																	
0	0	0	0	0	0	0	1	Value																																																	
1								/h																																																	
<table border="1"> <tr><td>7</td><td>6</td><td>5</td><td>4</td><td>3</td><td>2</td><td>1</td><td>0</td><td>bit</td></tr> <tr><td>0</td><td>0</td><td>0</td><td>0</td><td>0</td><td>0</td><td>1</td><td>0</td><td>Value</td></tr> <tr><td colspan="8">2</td><td>/h</td></tr> </table>	7	6	5	4	3	2	1	0	bit	0	0	0	0	0	0	1	0	Value	2								/h	<p>= DI2 (Base address +3) (0xA03)</p>	<table border="1"> <tr><td>7</td><td>6</td><td>5</td><td>4</td><td>3</td><td>2</td><td>1</td><td>0</td><td>bit</td></tr> <tr><td>0</td><td>0</td><td>0</td><td>0</td><td>0</td><td>0</td><td>1</td><td>0</td><td>Value</td></tr> <tr><td colspan="8">2</td><td>/h</td></tr> </table>	7	6	5	4	3	2	1	0	bit	0	0	0	0	0	0	1	0	Value	2								/h	<p>= DO2 Base address +2) (0xA02)</p>
7	6	5	4	3	2	1	0	bit																																																	
0	0	0	0	0	0	1	0	Value																																																	
2								/h																																																	
7	6	5	4	3	2	1	0	bit																																																	
0	0	0	0	0	0	1	0	Value																																																	
2								/h																																																	
<table border="1"> <tr><td>7</td><td>6</td><td>5</td><td>4</td><td>3</td><td>2</td><td>1</td><td>0</td><td>bit</td></tr> <tr><td>0</td><td>0</td><td>0</td><td>0</td><td>0</td><td>1</td><td>0</td><td>0</td><td>Value</td></tr> <tr><td colspan="8">4</td><td>/h</td></tr> </table>	7	6	5	4	3	2	1	0	bit	0	0	0	0	0	1	0	0	Value	4								/h	<p>= DI3 (Base address +3) (0xA03)</p>	<table border="1"> <tr><td>7</td><td>6</td><td>5</td><td>4</td><td>3</td><td>2</td><td>1</td><td>0</td><td>bit</td></tr> <tr><td>0</td><td>0</td><td>0</td><td>0</td><td>0</td><td>1</td><td>0</td><td>0</td><td>Value</td></tr> <tr><td colspan="8">4</td><td>/h</td></tr> </table>	7	6	5	4	3	2	1	0	bit	0	0	0	0	0	1	0	0	Value	4								/h	<p>= DO3 Base address +2) (0xA02)</p>
7	6	5	4	3	2	1	0	bit																																																	
0	0	0	0	0	1	0	0	Value																																																	
4								/h																																																	
7	6	5	4	3	2	1	0	bit																																																	
0	0	0	0	0	1	0	0	Value																																																	
4								/h																																																	
<table border="1"> <tr><td>7</td><td>6</td><td>5</td><td>4</td><td>3</td><td>2</td><td>1</td><td>0</td><td>bit</td></tr> <tr><td>0</td><td>0</td><td>0</td><td>0</td><td>1</td><td>0</td><td>0</td><td>0</td><td>Value</td></tr> <tr><td colspan="8">8</td><td>/h</td></tr> </table>	7	6	5	4	3	2	1	0	bit	0	0	0	0	1	0	0	0	Value	8								/h	<p>= DI4 (Base address +3) (0xA03)</p>	<table border="1"> <tr><td>7</td><td>6</td><td>5</td><td>4</td><td>3</td><td>2</td><td>1</td><td>0</td><td>bit</td></tr> <tr><td>0</td><td>0</td><td>0</td><td>0</td><td>1</td><td>0</td><td>0</td><td>0</td><td>Value</td></tr> <tr><td colspan="8">8</td><td>/h</td></tr> </table>	7	6	5	4	3	2	1	0	bit	0	0	0	0	1	0	0	0	Value	8								/h	<p>= DO4 Base address +2) (0xA02)</p>
7	6	5	4	3	2	1	0	bit																																																	
0	0	0	0	1	0	0	0	Value																																																	
8								/h																																																	
7	6	5	4	3	2	1	0	bit																																																	
0	0	0	0	1	0	0	0	Value																																																	
8								/h																																																	
<table border="1"> <tr><td>7</td><td>6</td><td>5</td><td>4</td><td>3</td><td>2</td><td>1</td><td>0</td><td>bit</td></tr> <tr><td>0</td><td>0</td><td>0</td><td>1</td><td>0</td><td>0</td><td>0</td><td>0</td><td>Value</td></tr> <tr><td colspan="8">10</td><td>/h</td></tr> </table>	7	6	5	4	3	2	1	0	bit	0	0	0	1	0	0	0	0	Value	10								/h	<p>= DI5 (Base address +3) (0xA03)</p>	<table border="1"> <tr><td>7</td><td>6</td><td>5</td><td>4</td><td>3</td><td>2</td><td>1</td><td>0</td><td>bit</td></tr> <tr><td>0</td><td>0</td><td>0</td><td>1</td><td>0</td><td>0</td><td>0</td><td>0</td><td>Value</td></tr> <tr><td colspan="8">10</td><td>/h</td></tr> </table>	7	6	5	4	3	2	1	0	bit	0	0	0	1	0	0	0	0	Value	10								/h	<p>= DO5 Base address +2) (0xA02)</p>
7	6	5	4	3	2	1	0	bit																																																	
0	0	0	1	0	0	0	0	Value																																																	
10								/h																																																	
7	6	5	4	3	2	1	0	bit																																																	
0	0	0	1	0	0	0	0	Value																																																	
10								/h																																																	
<table border="1"> <tr><td>7</td><td>6</td><td>5</td><td>4</td><td>3</td><td>2</td><td>1</td><td>0</td><td>bit</td></tr> <tr><td>0</td><td>0</td><td>1</td><td>0</td><td>0</td><td>0</td><td>0</td><td>0</td><td>Value</td></tr> <tr><td colspan="8">20</td><td>/h</td></tr> </table>	7	6	5	4	3	2	1	0	bit	0	0	1	0	0	0	0	0	Value	20								/h	<p>= DI6 (Base address +3) (0xA03)</p>	<table border="1"> <tr><td>7</td><td>6</td><td>5</td><td>4</td><td>3</td><td>2</td><td>1</td><td>0</td><td>bit</td></tr> <tr><td>0</td><td>0</td><td>1</td><td>0</td><td>0</td><td>0</td><td>0</td><td>0</td><td>Value</td></tr> <tr><td colspan="8">20</td><td>/h</td></tr> </table>	7	6	5	4	3	2	1	0	bit	0	0	1	0	0	0	0	0	Value	20								/h	<p>= DO6 Base address +2) (0xA02)</p>
7	6	5	4	3	2	1	0	bit																																																	
0	0	1	0	0	0	0	0	Value																																																	
20								/h																																																	
7	6	5	4	3	2	1	0	bit																																																	
0	0	1	0	0	0	0	0	Value																																																	
20								/h																																																	
<table border="1"> <tr><td>7</td><td>6</td><td>5</td><td>4</td><td>3</td><td>2</td><td>1</td><td>0</td><td>bit</td></tr> <tr><td>0</td><td>1</td><td>0</td><td>0</td><td>0</td><td>0</td><td>0</td><td>0</td><td>Value</td></tr> <tr><td colspan="8">40</td><td>/h</td></tr> </table>	7	6	5	4	3	2	1	0	bit	0	1	0	0	0	0	0	0	Value	40								/h	<p>= DI7 (Base address +3) (0xA03)</p>	<table border="1"> <tr><td>7</td><td>6</td><td>5</td><td>4</td><td>3</td><td>2</td><td>1</td><td>0</td><td>bit</td></tr> <tr><td>0</td><td>1</td><td>0</td><td>0</td><td>0</td><td>0</td><td>0</td><td>0</td><td>Value</td></tr> <tr><td colspan="8">40</td><td>/h</td></tr> </table>	7	6	5	4	3	2	1	0	bit	0	1	0	0	0	0	0	0	Value	40								/h	<p>= DO7 Base address +2) (0xA02)</p>
7	6	5	4	3	2	1	0	bit																																																	
0	1	0	0	0	0	0	0	Value																																																	
40								/h																																																	
7	6	5	4	3	2	1	0	bit																																																	
0	1	0	0	0	0	0	0	Value																																																	
40								/h																																																	
<table border="1"> <tr><td>7</td><td>6</td><td>5</td><td>4</td><td>3</td><td>2</td><td>1</td><td>0</td><td>bit</td></tr> <tr><td>1</td><td>0</td><td>0</td><td>0</td><td>0</td><td>0</td><td>0</td><td>0</td><td>Value</td></tr> <tr><td colspan="8">80</td><td>/h</td></tr> </table>	7	6	5	4	3	2	1	0	bit	1	0	0	0	0	0	0	0	Value	80								/h	<p>= DI8 (Base address +3) (0xA03)</p>	<table border="1"> <tr><td>7</td><td>6</td><td>5</td><td>4</td><td>3</td><td>2</td><td>1</td><td>0</td><td>bit</td></tr> <tr><td>1</td><td>0</td><td>0</td><td>0</td><td>0</td><td>0</td><td>0</td><td>0</td><td>Value</td></tr> <tr><td colspan="8">80</td><td>/h</td></tr> </table>	7	6	5	4	3	2	1	0	bit	1	0	0	0	0	0	0	0	Value	80								/h	<p>= DO8 Base address +2) (0xA02)</p>
7	6	5	4	3	2	1	0	bit																																																	
1	0	0	0	0	0	0	0	Value																																																	
80								/h																																																	
7	6	5	4	3	2	1	0	bit																																																	
1	0	0	0	0	0	0	0	Value																																																	
80								/h																																																	

5.1.1.7 DIO I/O Port Address (Default Address 0xA00)

Pin Definition	DI8	DI7	DI6	DI5	DI4	DI3	DI3	DI1
----------------	-----	-----	-----	-----	-----	-----	-----	-----

Data Bits	7	6	5	4	3	2	1	0
DIO Type	Digital Input							
I/O Port Address	0xA03							

Pin Definition	DO8	DO7	DO6	DO5	DO4	DO3	DO3	DO1
Data Bits	7	6	5	4	3	2	1	0
DIO Type	Digital Output							
I/O Port Address	0xA02							

5.2 DIO Hardware Specification

- XCOM+: Isolated power in V+
- XCOM-: Isolated power in V-
- Isolated power in DC voltage: 9-30V
- 8x Digital Input (Source Type)
- Input Signal Voltage Level
 - Signal Logic 0: XCOM+ = 9V, Signal Low - V- < 1V

$$\text{XCOM+} > 9\text{V}, \quad \text{V+} - \text{Signal Low} > 8\text{V}$$
 - Signal Logic 1: > XCOM+ - 3V
- Input Driving Sink Current:
 - Minimal: 1 mA
 - Normal: 5 mA
- 8x Digital Output (Open Drain)
 - DO Signal have to pull up resistor to XCOM+ for external device, the resistance will affect the pull up current
 - Signal High Level: Pull up resistor to XCOM+
 - Signal Low Level: = XCOM-
 - Sink Current: 1A (Max)

5.2.1 DIO Connector Definition

DIO1/DIO2: Digital Input / Output Connector

Connector Type: Terminal Block 2X10 10-pin, 3.5mm pitch

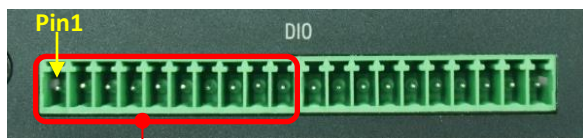

DIO1 (Digital Input)

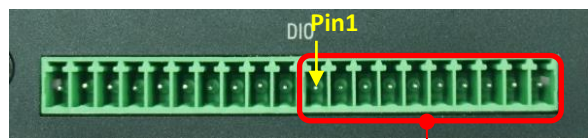

DIO2 (Digital Output)

Location	Pin	Definition
DIO1	1	DC INPUT (XCOM+)
	2	DI1
	3	DI2
	4	DI3
	5	DI4
	6	DI5
	7	DI6
	8	DI7
	9	DI8
	10	GND (XCOM-)

Location	Pin	Definition
DIO2	1	DC INPUT (XCOM+)
	2	DO1
	3	DO2
	4	DO3
	5	DO4
	6	DO5
	7	DO6
	8	DO7
	9	DO8
	10	GND (XCOM-)

Reference Input Circuit

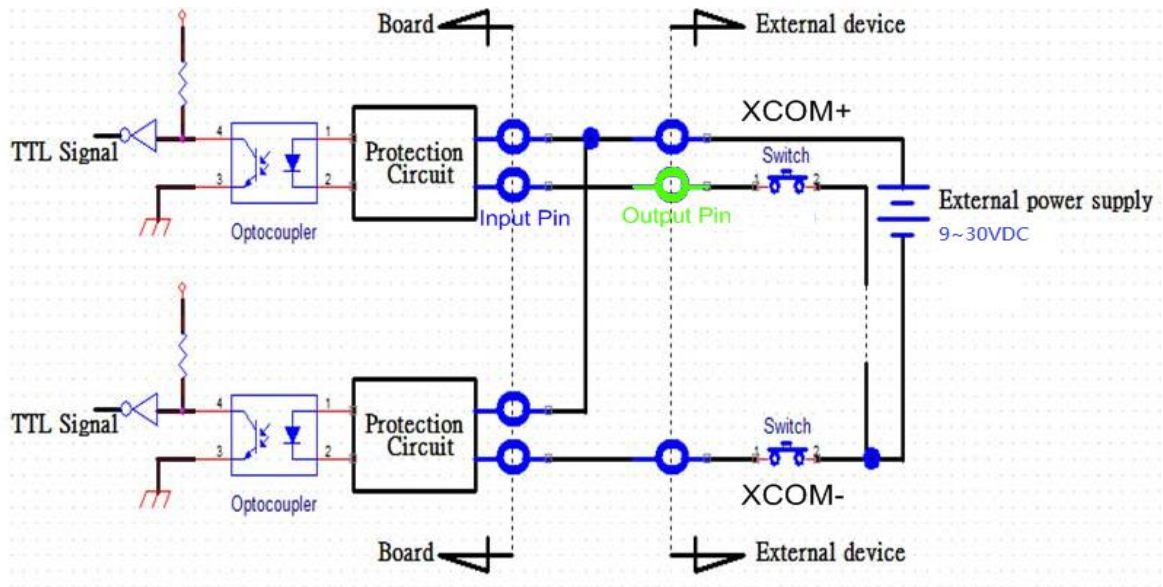

Reference Output Circuit

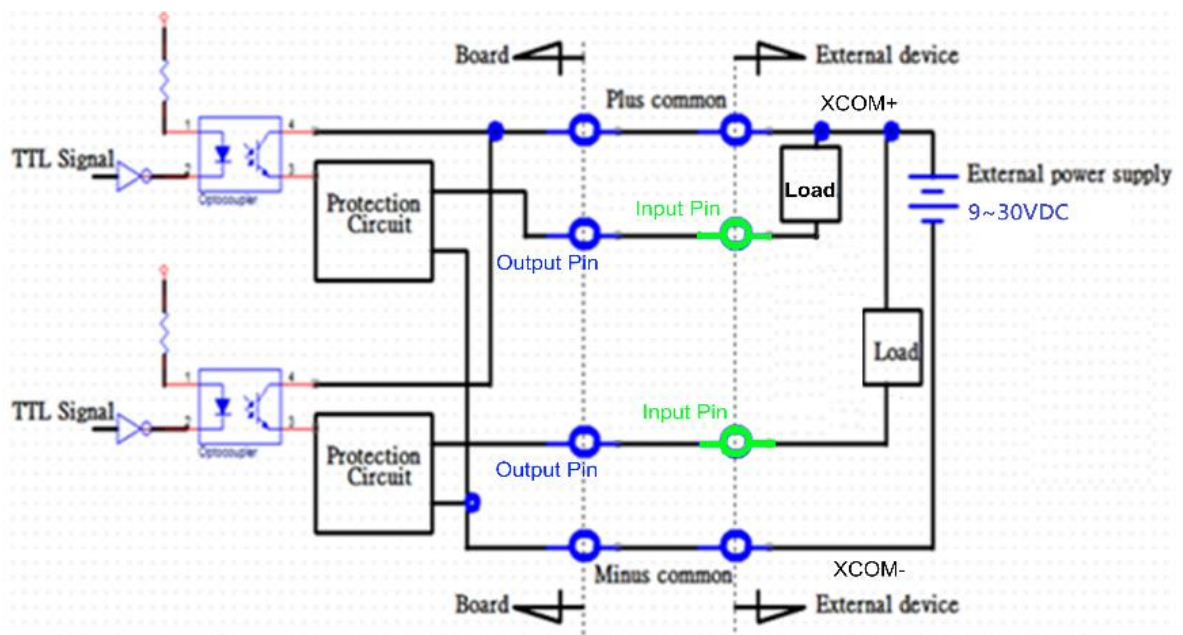



Chapter 6

Optional Modules and Accessories

6.1 Pin Definition & Settings

6.1.1 CMI-M12LAN01-R12/ UB1710-R10

Model No.	Product Description
CMI-M12LAN01-R12/U B1710-R10	CMI Module with M12 Connector, 4x Intel GbE LAN / Universal Bracket with 4x M12 A-Coded Cutout

Connector Type: M12 A coded 8pin connector

Pin	Definition	Pin	Definition
1	2_LAN1_0+	2	2_LAN1_0-
3	2_LAN1_1+	4	2_LAN1_2+
5	2_LAN1_2-	6	2_LAN1_1-
7	2_LAN1_3+	8	2_LAN1_3-

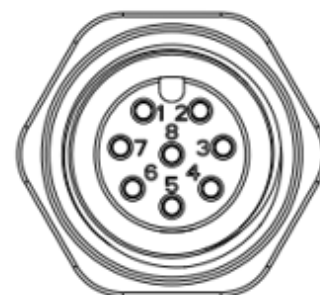

6.1.2 CMI-XM12LAN01-R10/ UB0930-R10

Model No.	Product Description
CMI-XM12LAN01-R10/ UB0930-R10	CMI Module with M12 X-Coded Connector, 4x Intel I210 GbE LAN Ports / Universal Bracket with 4x M12 X-Coded Cutout

Connector Type: M12 X coded 8pin connector

Pin	Definition	Pin	Definition
1	D1+	2	D1-
3	D2+	4	D2-
5	D4+	6	D4-
7	D3-	8	D3+

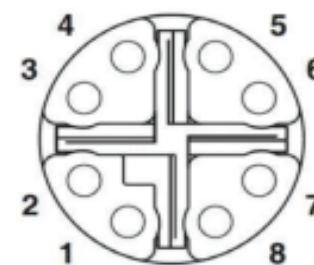

6.1.3 CMI-COM01/UB1303

Model No.	Product Description
CMI-COM01/UB1303	CMI Module with 2x RS232/422/485 (Support 5V/12V)/ Universal Bracket with 2x DB9 Cutout

COM5 / COM6: RS232 / RS422 / RS485 Connector

Connector Type: 9-pin D-Sub

Pin	RS232 Definition	RS422 / 485 Full Duplex Definition	RS485 Half Duplex Definition
1	DCD	TX-	DATA -
2	RXD	TX+	DATA +
3	TXD	RX+	
4	DTR	RX-	
5	GND		
6	DSR		
7	RTS		
8	CTS		
9	RI		



SW2: COM5/COM6 Power Select

Location	Function	DIP1	DIP2
SW2 on CMI-COM Module	COM5	0V(RI)	ON (Default)
		5V	ON
		12V	OFF

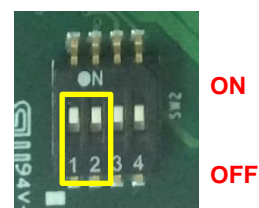

Location	Function	DIP3	DIP4
SW2 on CMI-COM Module	COM6	0V(RI)	ON (Default)
		5V	ON
		12V	OFF

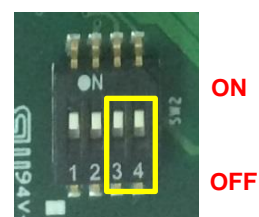

6.1.4 CFM-IGN01

Model No.	Product Description
CFM-IGN01	CFM Module with Power Ignition Sensing Control Function, 12V/24V Selectable

SW2: IGN Module Timing Setting Switch

Set shutdown delay timer when ACC is turned off

Pin 1	Pin 2	Pin 3	Pin 4	Definition
ON	ON	ON	ON (IGN enabled)	0 second
ON	ON	OFF		1 minute
ON	OFF	ON		5 minutes
ON	OFF	OFF		10 minutes
OFF	ON	ON	/	30 minutes
OFF	ON	OFF	OFF (IGN disabled)	1 hour
OFF	OFF	ON		2 hours
OFF	OFF	OFF		Reserved (0 second)

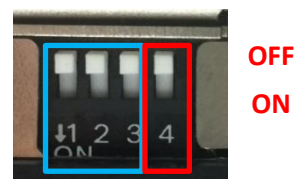

24V_12V_1: IGN Module Voltage Mode Setting Switch

12V / 24V Car Battery Switch

Pin	Definition
1-2(right)	24V Car Battery Input (Default)
2-3(left)	12V Car Battery Input



6.2 Installing a High Speed CMI Module

6.2.1 CMI-10GLAN05-R10/UB1728-R10

Model No.	Product Description
CMI-10GLAN05-R10/UB1728-R10	CMI Module with 2x Intel 10GbE LAN, RJ45 Port/ Universal Bracket with 2x RJ45 Cutout

1. Locate the chip place on the CMI-10GLAN05-R10 module marked by red square. Paste the thermal pad on it carefully.

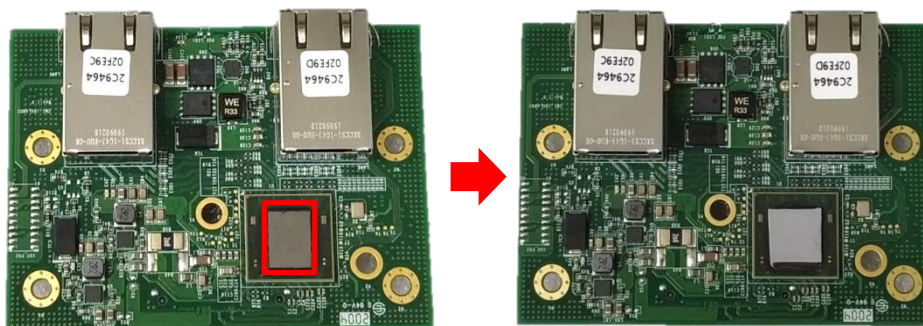

CAUTION (ATTENTION)

Before putting on the thermal block (in the next step), please make sure the protective film on the Thermal Pad has been removed!

(Avant de mettre le bloc thermique (à l'étape suivante), veuillez vous assurer que le film protecteur sur le coussin thermique a été retiré!)

2. Put on the heatsink and turn over the module. Fasten the screw to fix the heatsink.

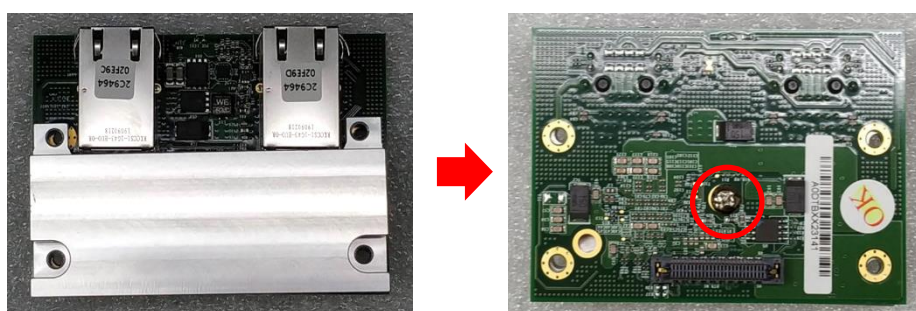

3. Loosen screws on the front bezel to remove the cover plate 1 or 2.



4. Locate the CMI connector(s) BTB_FH1 or BTB_FH3 on the top side of system.

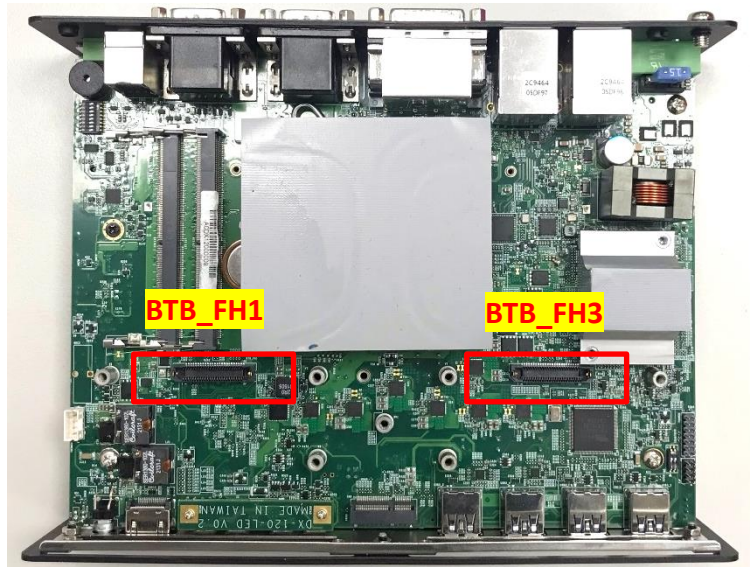

5. Replace the indicated screw(s) by copper pillar(s). (copper pillar: M3x10)

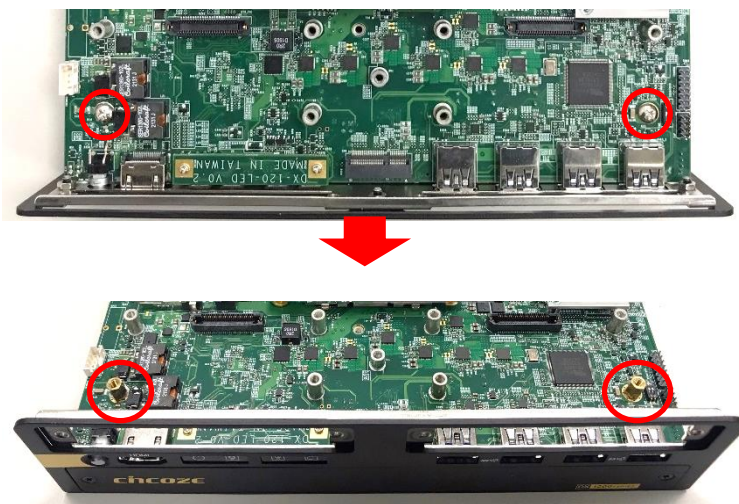

6. Insert the CMI module vertically into the connector BTB_FH1 or BTB_FH3 until it's connected firmly and fasten screws to fix it. (screw: M3x12)

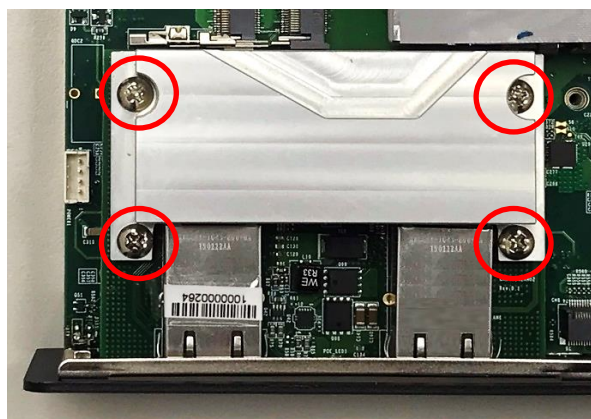

7. Paste the last thermal pad onto the heatsink carefully.



CAUTION
(ATTENTION)

Before assembling the system's chassis cover, please make sure the protective film on the Thermal Pad has been removed!
(Avant d'assembler le couvercle du châssis du système, assurez-vous que le film protecteur sur le coussin thermique a été retiré !d'alimentation CC au système.)

8. Attach the I/O bracket, and fasten the two screws to fix it for each cover plate. for each cover plate.



Before the application of CMI-10GLAN05 module, please be noted to change the [BTB_FH1 Mode Selection] or [BTB_FH3 Mode Selection] setting, at the page of PCH-IO Configuration, from default mode [4x1] to mode [1x4] to enable the function.

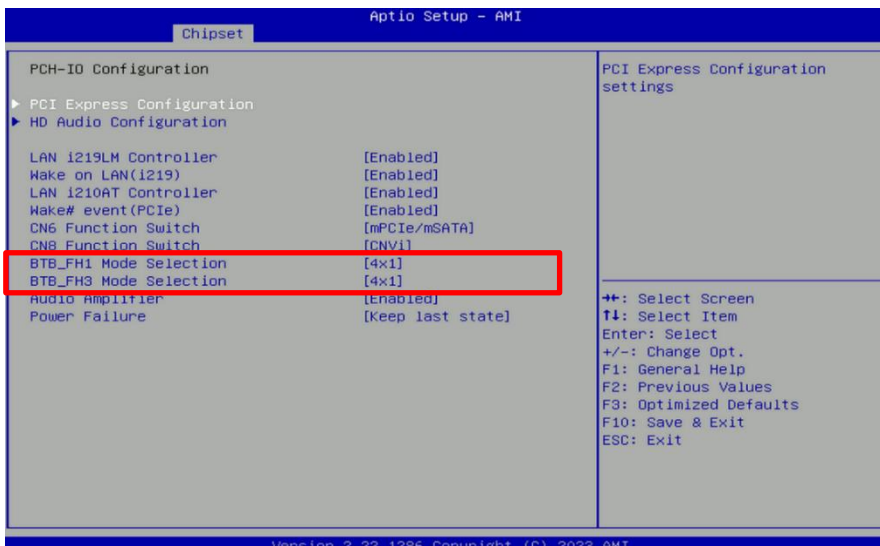

6.2.2 CMI-LAN01-R12/UB1712-R10

Model No.	Product Description
CMI-LAN01-R12/UB171	CMI Module with 4x Intel I210 GbE LAN, RJ45 Port / Universal Bracket 2-R10

1. Loosen screws on the front bezel to remove the cover plate 1 or 2.



2. Locate the CMI connector(s) BTB_FH1 or BTB_FH3 on the top side of system.

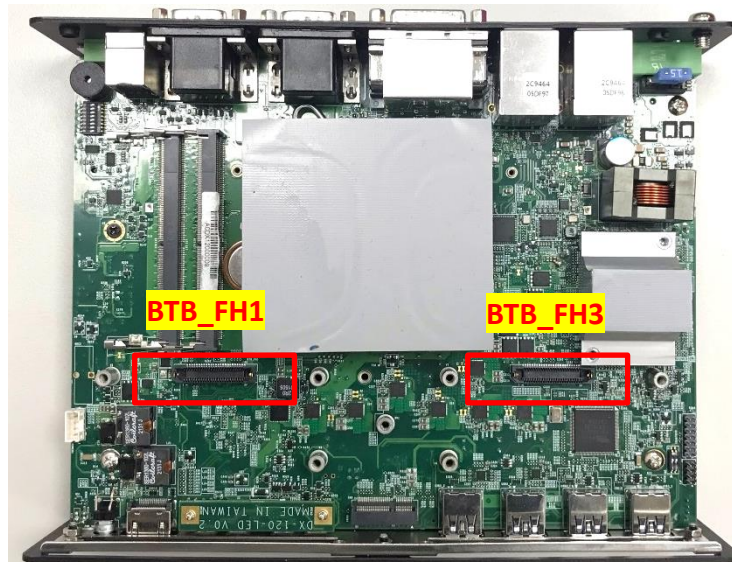

3. Replace the indicated screw(s) by copper pillar(s). (copper pillar: M3x10)

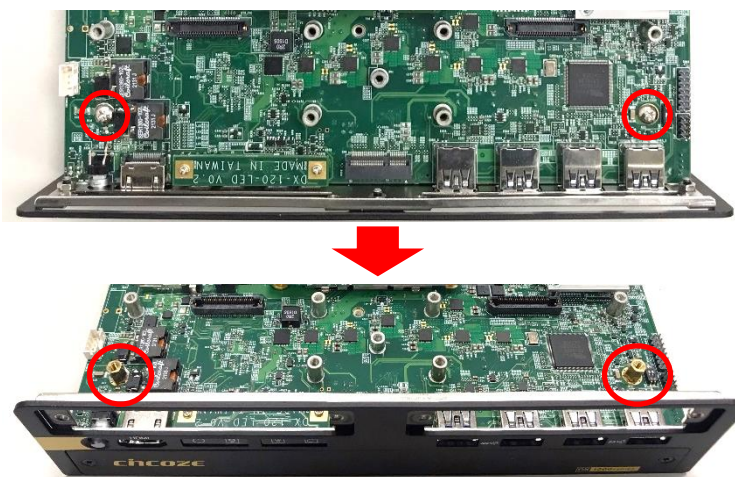

4. Insert the CMI module vertically into the connector BTB_FH1 or BTB_FH3 until it's connected firmly and fasten screws to fix it. (screw: M3x5)

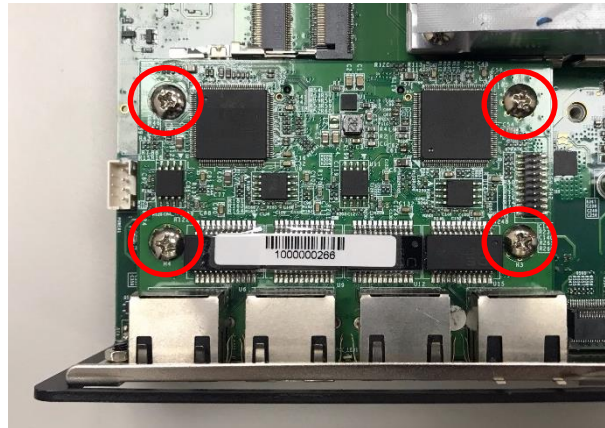

5. Attach the I/O bracket, and fasten the two screws to fix it for each cover plate.



6.2.3 CMI-M12LAN01-R12/UB1710-R10

Model No.	Product Description
CMI-M12LAN01-R12/U B1710-R10	CMI Module with M12 Connector, 4x Intel GbE LAN / Universal Bracket with 4x M12 A-Coded Cutout

1. Remove the nuts and O-rings on the respective M12 connectors.

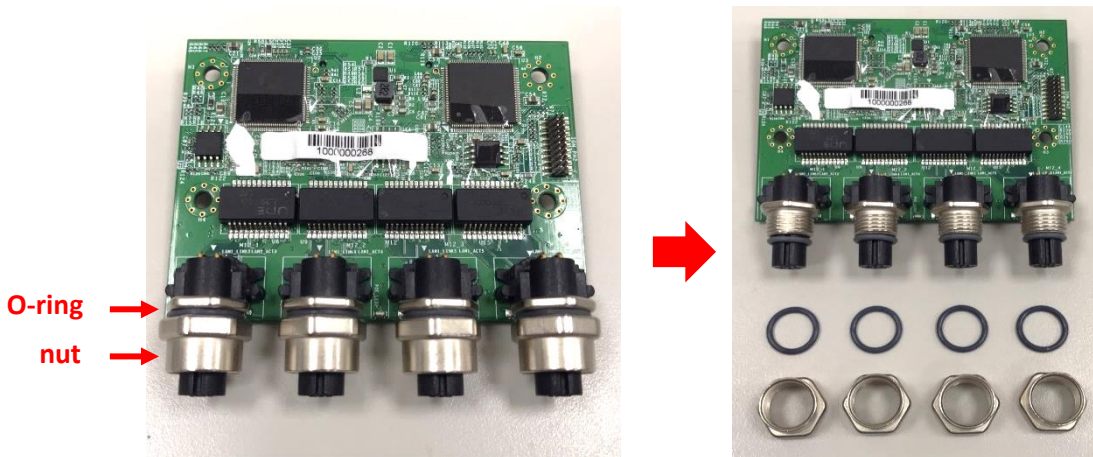

2. Loosen screws on the front bezel to remove the cover plate 1 or 2.



3. Locate the CMI connector(s) BTB_FH1 or BTB_FH3 on the top side of system.

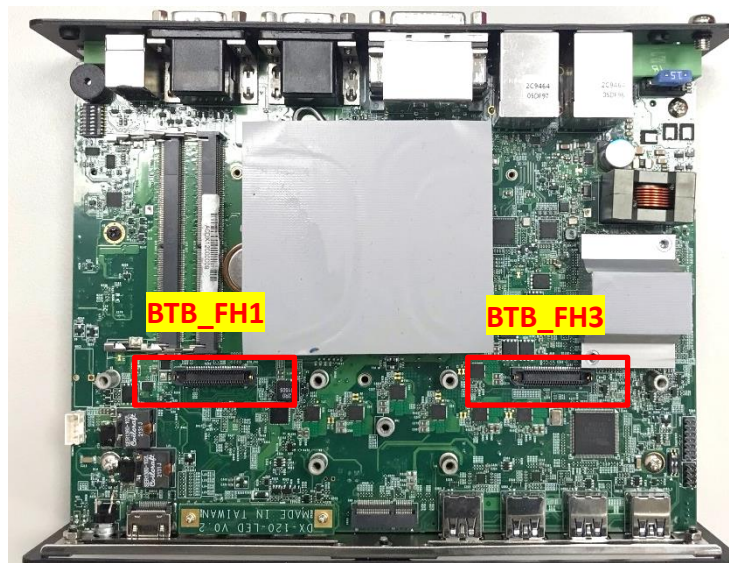

4. Replace the indicated screw(s) by copper pillar(s). (copper pillar: M3x10)

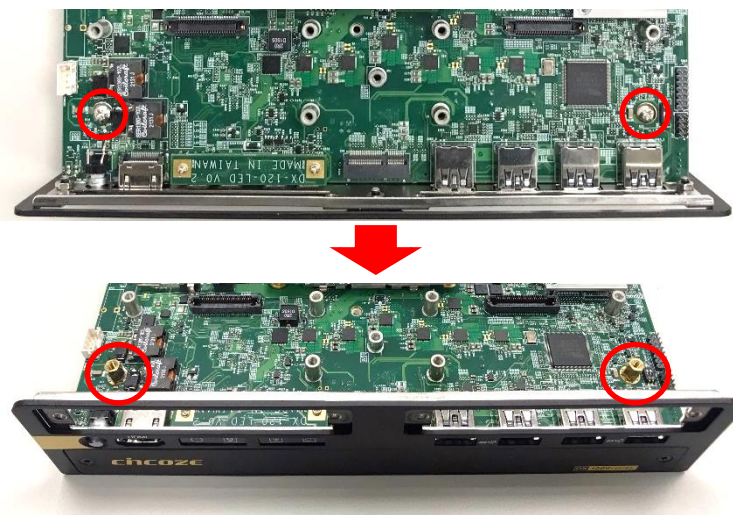

5. Insert the CMI module vertically into the connector BTB_FH1 or BTB_FH3 until it's connected firmly and fasten screws to fix it. (screw: M3x5)

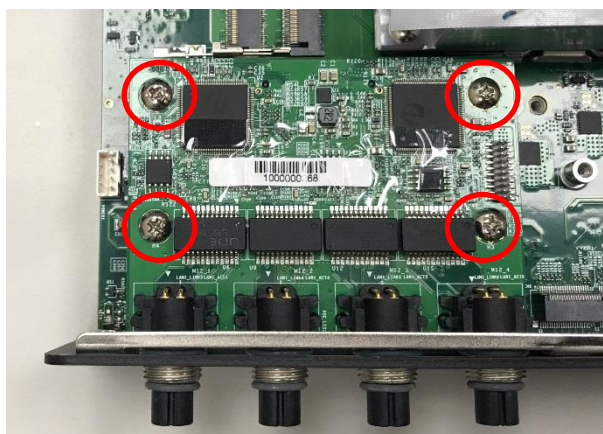

6. Attach the I/O bracket, and fasten the two screws to fix it for each cover plate.



7. Put the 4 O-rings back.



8. Put the 4 nuts back.



6.2.4 CMI-XM12LAN01-R10/UB0930-R10

Model No.	Product Description
CMI-XM12LAN01-R10/ UB0930-R10	CMI Module with M12 X-Coded Connector, 4x Intel I210 GbE LAN Ports / Universal Bracket with 4x M12 X-Coded Cutout

1. Remove the hex washers, nuts and O-rings on the respective M12 connectors.

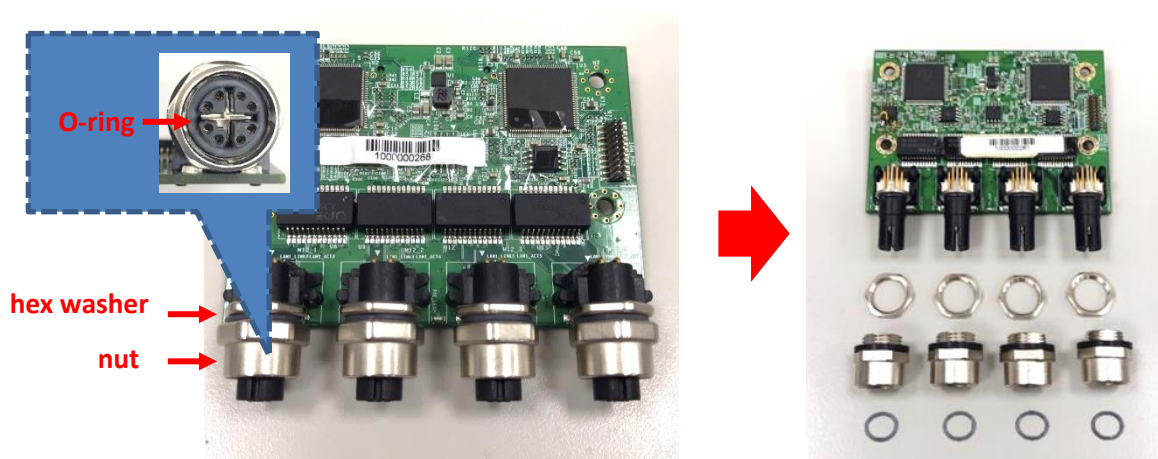

2. Assemble the hex rings, M12 I/O bracket and hex washers together as indicated below: Penetrate hex rings through the M12 I/O bracket holes, and fix them with hex washers.

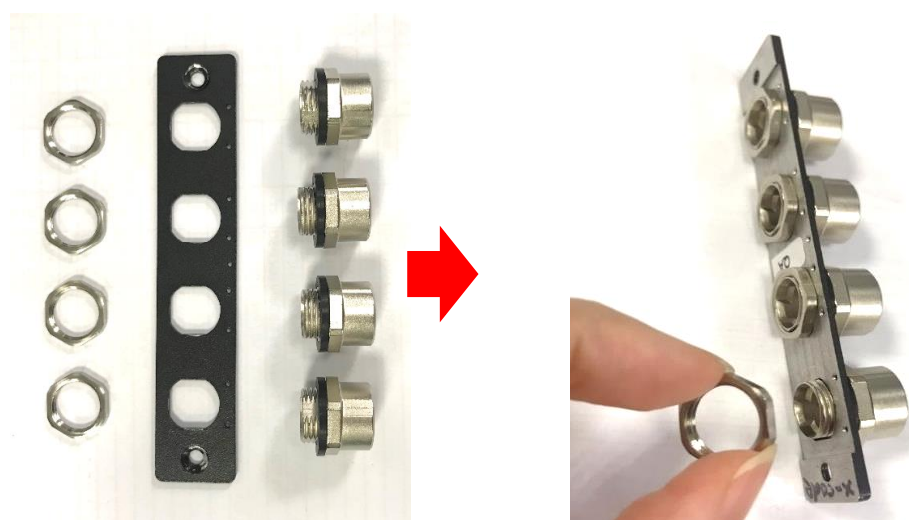

3. Loosen screws on the front bezel to remove the cover plate 1 or 2.

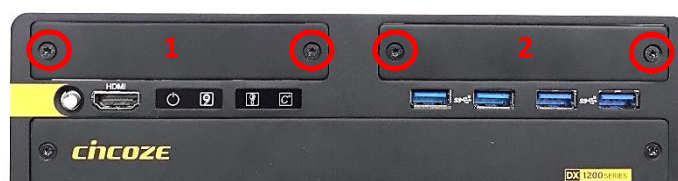

4. Locate the CMI connector(s) BTB_FH1 or BTB_FH3 on the top side of system.

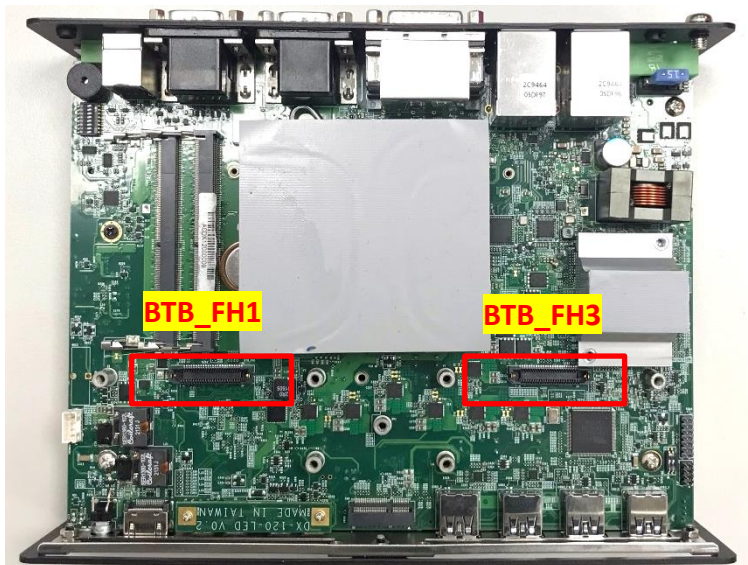

5. Replace the indicated screw(s) by copper pillar(s). (copper pillar: M3x10)

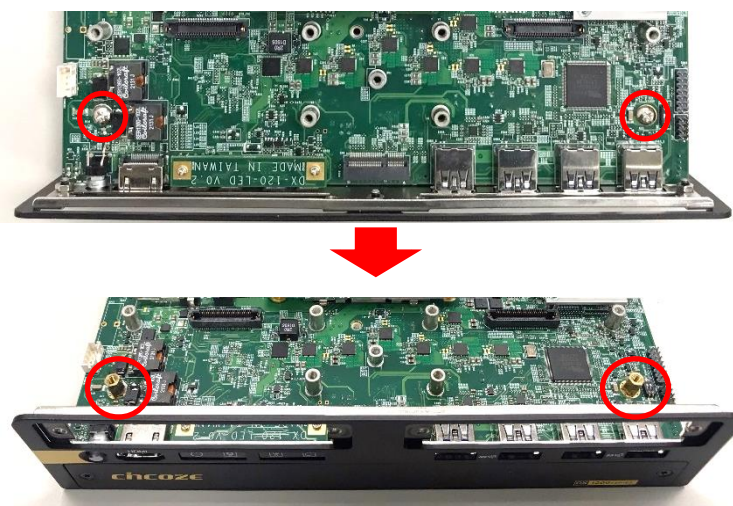

6. Insert the CMI module vertically into the connector BTB_FH1 or BTB_FH3 until it's connected firmly and fasten screws to fix it. (screw: M3x5)

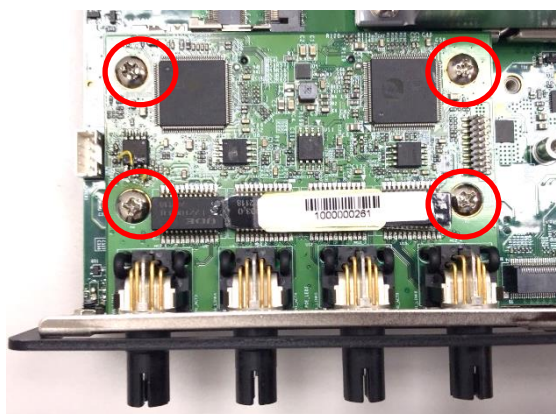

7. Attach the assembled I/O bracket, and fasten the two screws to fix it for each cover plate.



8. Put on the O-rings back to the four M12 LAN ports.

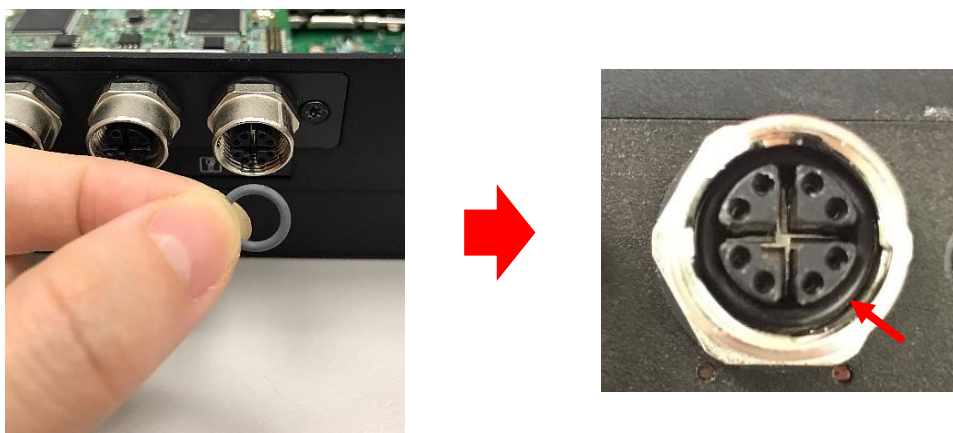

6.3 Installing Low Speed CMI Module

6.3.1 CMI-COM01/UB1303

Model No.	Product Description
CMI-COM01/UB1303	CMI Module with 2x RS232/422/485 (Support 5V/12V) / Universal Bracket with 2x DB9 Cutout

1. Loosen screws on the front bezel to remove the cover plate 4.



2. Locate the CMI connector BTB_FH2 on the bottom side of system.

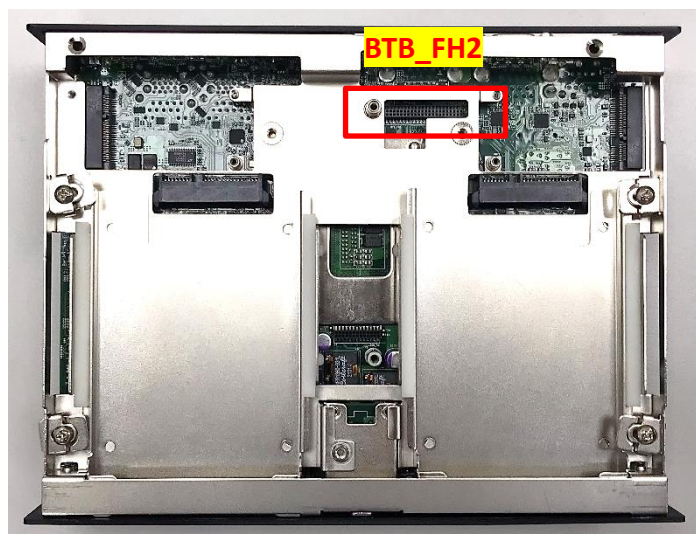

3. Penetrate the bracket hole and then insert the CMI module vertically into the connector BTB_FH2 until it's connected firmly and fasten screws to fix it. (screw1: M3x5, Countersunk, screw2: M3x5, Mushroom)

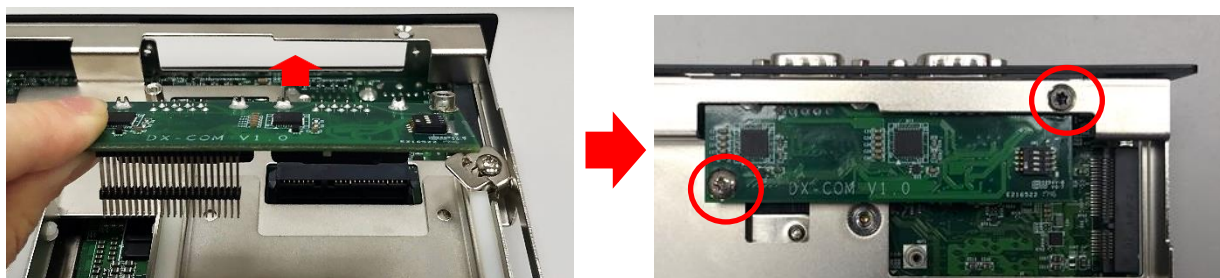

- Attach the I/O bracket, and fasten 2 screws and 4 D-Sub jack screws to fix it.



6.3.2 CMI-DIO01/UB1318

Model No.	Product Description
CMI-DIO01/UB1318	CMI Module with 16DIO (8in 8out) / Universal Bracket with DIO Cutout

- Loosen screws on the front bezel to remove the cover plate 4.



- Locate the CMI connector BTB_FH2 on the bottom side of system.

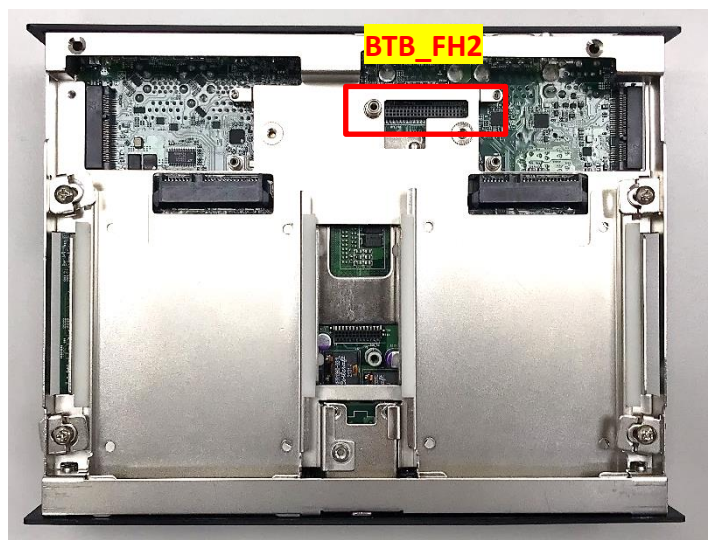

3. Penetrate the bracket hole and then insert the CMI module vertically into the connector BTB_FH2 until it's connected firmly and fasten screws to fix it. (screw1: M3x5, Countersunk, screw2: M3x5, Mushroom)

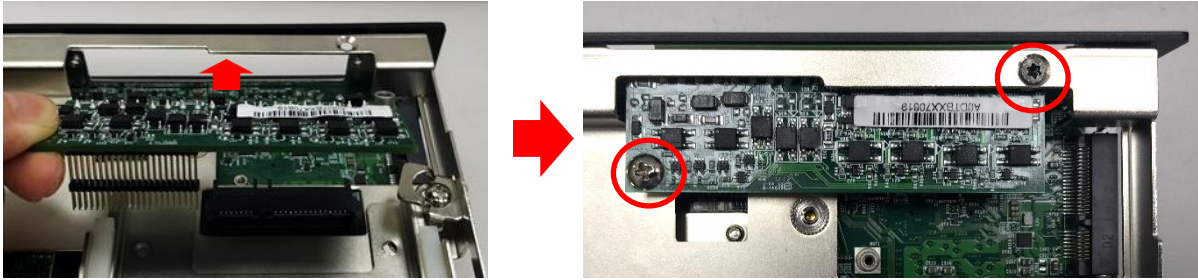

4. Attach the I/O bracket, and fasten 2 screws to fix it.



6.4 Installing CFM Modules

6.4.1 CFM-PoE01

Model No.	Product Description
CFM-PoE01	CFM Module with PoE Control Function, Individual Port 25.5W

This module should be installed onto the CMI-LAN01, CMI-M12LAN01 or CMI-XM12LAN01 module. The following installing steps will take the CMI-LAN01 module for example.

1. If you use CMI-LAN module, please paste the shading tape to the place which was marked by red circle. If you use CMI-M12LAN module please skip this step.

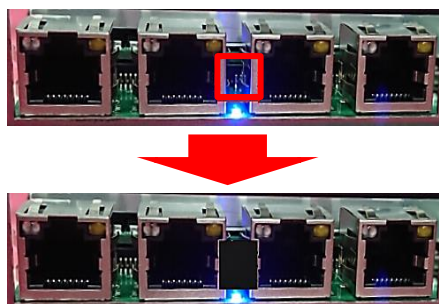

2. Please follow the step 1 to step 3 in chapter 6.2.2. Insert the CMI module vertically into the connector BTB_FH1 or BTB_FH3 until it's connected firmly.



3. Fasten the four copper pillars. (copper pillar: M3x5)



4. Insert the CFM-PoE01 module vertically into the female connector on the CMI module until it's connected firmly.



5. Turn over the heatsink of CFM-PoE01 and locate the two places marked by red squares.

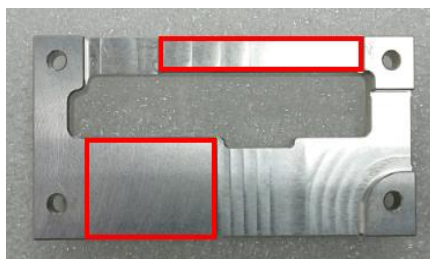

- Paste two thermal pads for CFM-PoE01 onto the heatsink carefully.

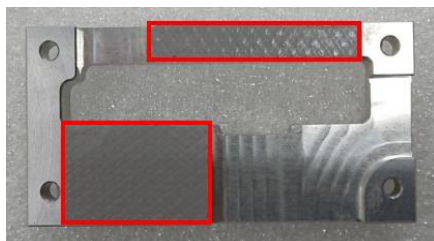

CAUTION
(ATTENTION)

Before putting on the thermal block (in the next step), please make sure the protective film on the Thermal Pad has been removed!

(Avant de mettre le bloc thermique (à l'étape suivante), veuillez vous assurer que le film protecteur sur le coussin thermique a été retiré!)

- Paste the heatsink onto the CMI-PoE module carefully and connect the PoE module to the LAN module.

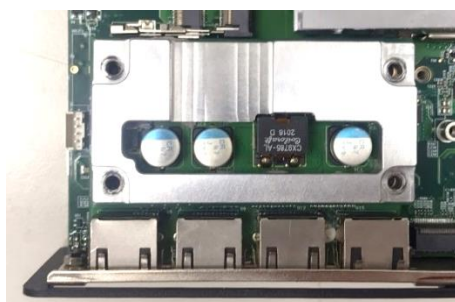

- Fasten 4 screws to fix it.

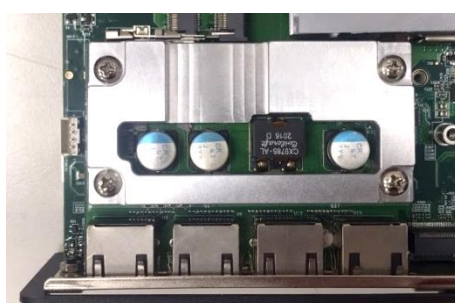

9. Paste the last thermal pad onto the heatsink carefully.

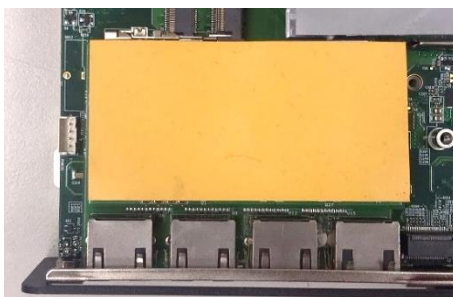

CAUTION
(ATTENTION)

The yellow surface is part of the thermal pad. Do not tear it off as it would affect the thermal conductivity.
(La surface jaune fait partie du coussin thermique. Ne l'arrachez pas car cela affecterait la conductivité thermique.)

6.4.2 CFM-IGN01

Model No.	Product Description
CFM-IGN01	CFM Module with Power Ignition Sensing Control Function, 12V/24V Selectable

1. Locate the IGN connector on the bottom side of system.

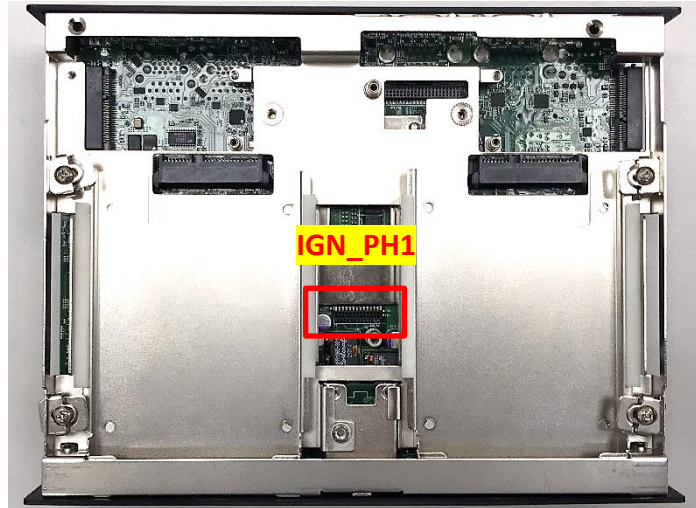

2. Fasten 1 copper pillar before insert IGN module. (copper pillar: M3x9)



3. Insert IGN module vertically to the female connector on the system's mainboard, and fasten 2 screws to fix it.



6.5 Installing MEC Modules

6.5.1 MEC-COM-M212-TDB9/UB1303

Model No.	Product Description
MEC-COM-M212-TDB9 /UB1303	Mini-PCIe Module with 2x RS-232 Serial Ports, 1x Thin DB9 Cable / Universal Bracket with 2x DB9 Cutout

1. Loosen screws on the front bezel to remove the cover plate 3 or 4.



2. Locate the mPCIe connector CN6 or CN7 on the bottom side of system.

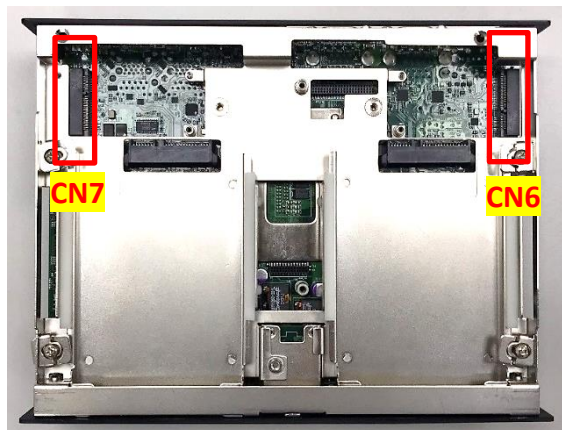

3. Insert the mPCIe card at 45 degrees until its edge connector is connected firmly into the slot.



4. Press the card down and secure it with 2 screws.

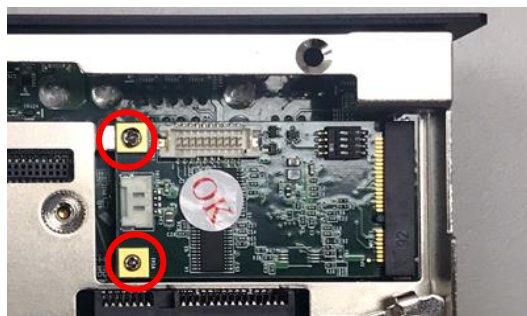

5. Insert the female connector of the flat ribbon cable to the connector on the mPCIe card.



6. Fasten the 4 D-Sub jack screws onto the I/O bracket.

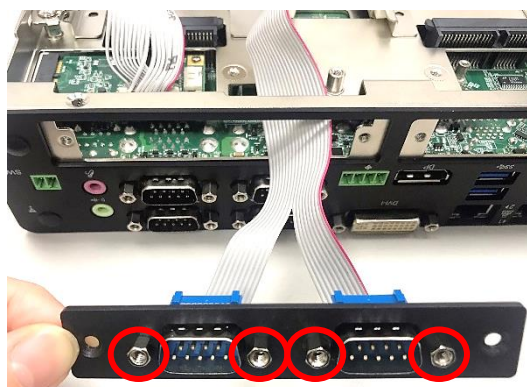

7. Attach the I/O bracket, and fasten the two screws to fix it for each cover plate.



6.5.2 MEC-COM-M334-TDB9/2xUB1303

Model No.	Product Description
MEC-COM-M334-TDB9 /2xUB1303	Mini-PCIe Module with 4x RS-232/422/485 Serial Ports, 2x Thin DB9 Cable / 2x Universal Bracket with 2x DB9 Cutout

1. Loosen screws on the front bezel to remove the cover plate 3 and 4.



2. Locate the mPCIe connector CN6 or CN7 on the bottom side of system.

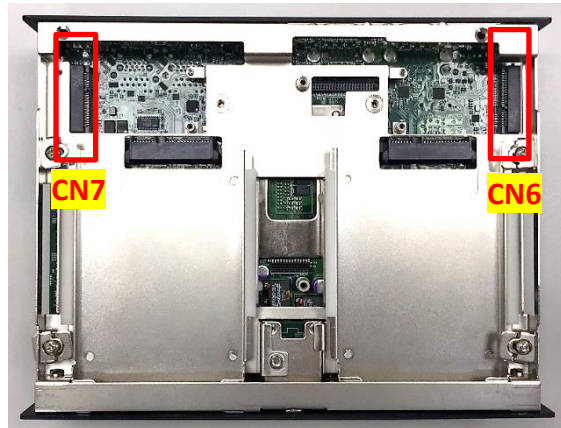

3. Insert the mPCIe card at 45 degrees until its edge connector is connected firmly into the slot.

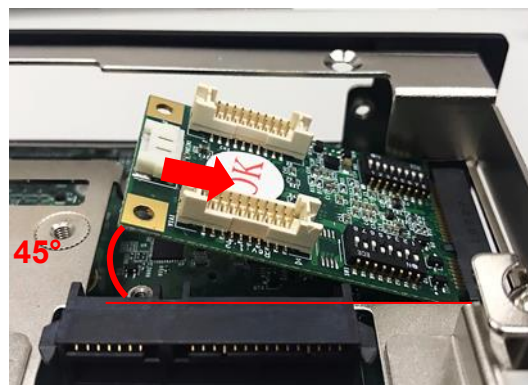

4. Press the card down and secure it with 2 screws.

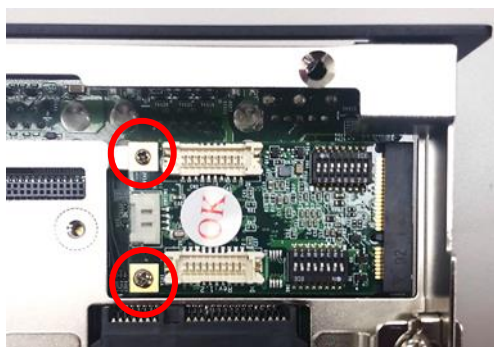

5. Insert the female connectors of the flat ribbon cable to the connectors on the mPCIe card.

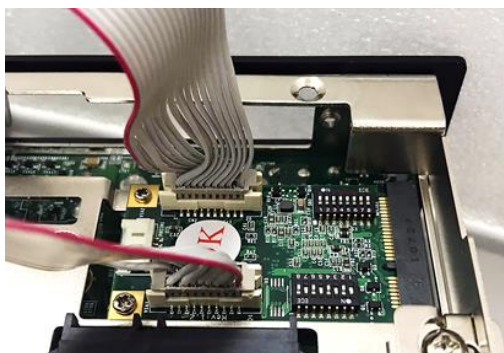

6. Fasten the D-Sub jack screws onto the I/O brackets.

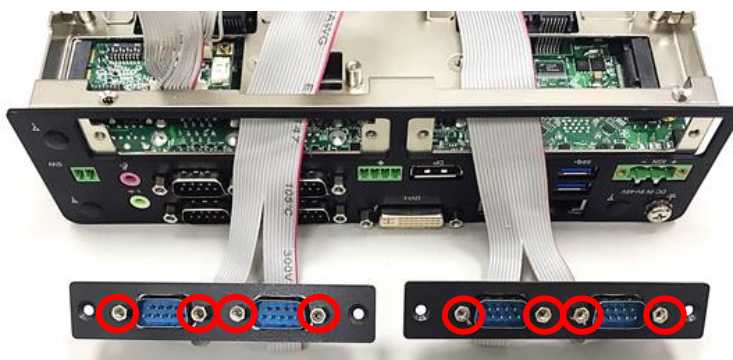

7. Attach the I/O brackets, and fasten the four screws to fix it for each cover plate.



6.5.3 MEC-LAN-M102-30/UB1311

Model No.	Product Description
MEC-LAN-M102-30/UB1311	Mini-PCIe Module with 2x LAN Ports, 2x 30cm cable / Universal Bracket with 2x RJ45 Cutout for MEC-LAN Expansion

1. Loosen screws on the front bezel to remove the cover plate 3.



2. Locate the mPCIe connector CN6 on the bottom side of system.

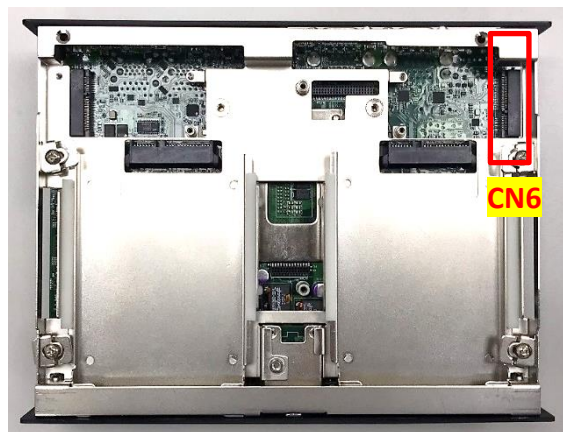

3. Insert the mPCIe card at 45 degrees until its edge connector is connected firmly into the slot.



4. Press the card down and secure it with 2 screws.



5. Insert the female connectors of the flat ribbon cable to the connectors on the mPCIe card.

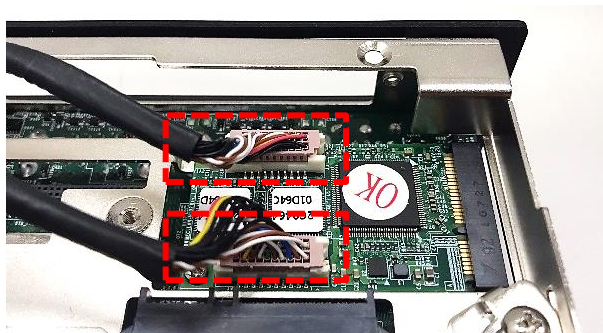

6. Insert the female connectors of the flat ribbon cable to the connectors on the LAN card.

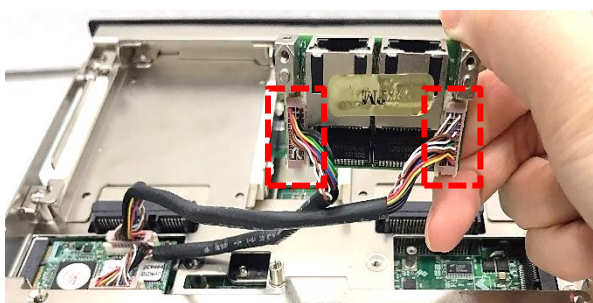

7. Attach the I/O bracket, and fasten the two screws to fix the LAN module.



8. Attach the I/O bracket, and fasten the two screws to fix it for each cover plate.



6.6 Installing Optional Accessories

6.6.1 SIDE-DX

Model No.	Product Description
SIDE-DX	DX Series side mount kit

DX-1200 offers Side Mount that customer can install system to the right or left side of wall to create effective of space.



1. The mounting holes are at the bottom of system. Fasten the 8 screws to fix the side mount bracket with system together.

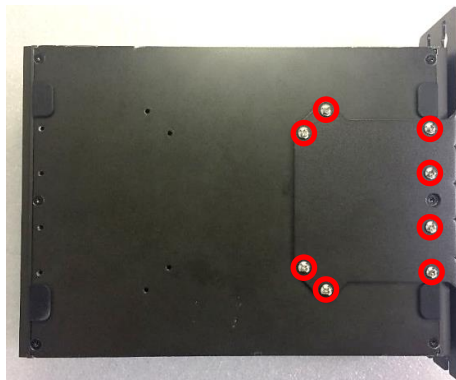

2. Fasten the screws through the bracket mounting hole to mount system on the wall.



6.6.2 DIN01

Model No.	Product Description
DIN01	DIN-RAIL Mount Kit, KMRH-K175

DX-1200 offers DIN-Rail Mount Kit that customer can install system onto the DIN Rail.



1. Please refer to chapter 3.14 to install wall mount bracket at both sides of system, and fasten each DIN rail mounting clip onto each side of wall mount brackets with 2 screws (screw size: T3x10.5).

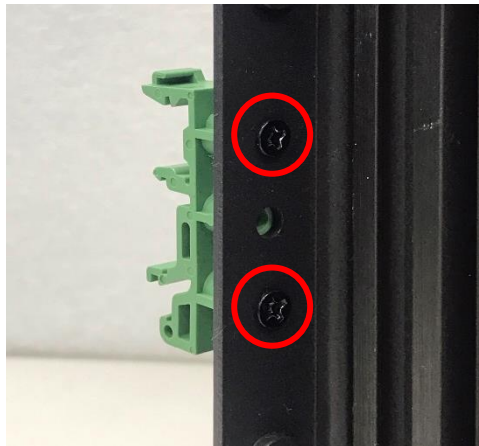

2. Then user can clip the system onto the DIN rail through the DIN Rail Kit.



6.6.3 FAN-EX101

Model No.	Product Description
FAN-EX101	External Fan with 4pin Terminal Block Plug and Mounting Bracket, Support smart fan

1. Prepare an external fan. Loosen the 2 screws halfway on mounting frame before attempting to install it.

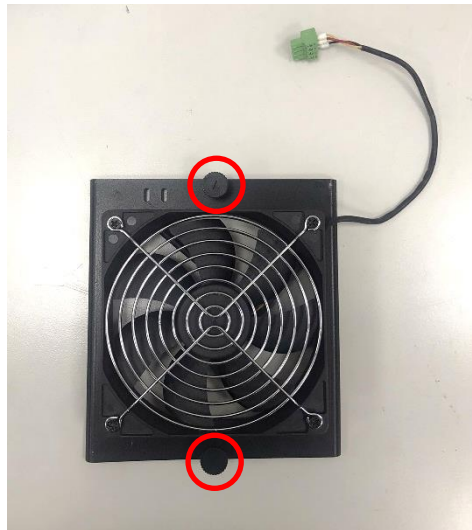

2. Slide the FAN into the middle groove of chassis as illustrated. Tighten the 2 screws to fix it onto chassis.

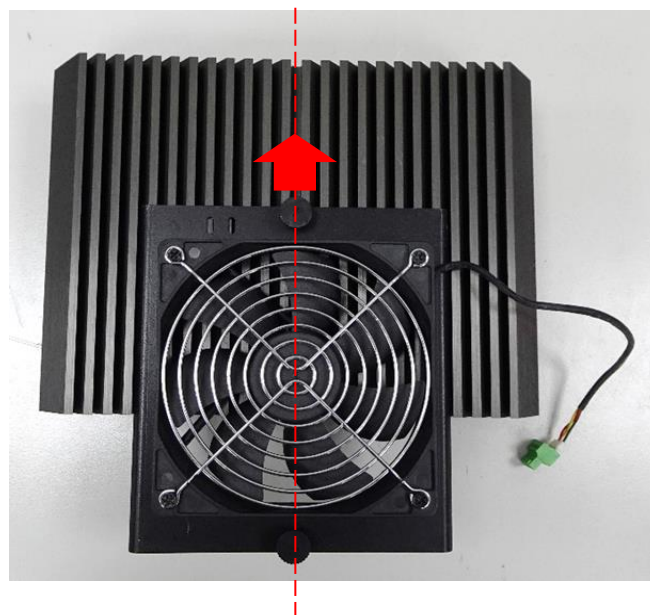

3. Move the fan to the center of chassis. Tighten the 2 screws marked on photo to secure it.



4. Connect the FAN cable to external fan power connector at rear panel.



cincoze

© 2023 Cincoze Co., Ltd. All rights reserved.

The Cincoze logo is a registered trademark of Cincoze Co., Ltd.

All other logos appearing in this catalog are the intellectual property of the respective company, product, or organization associated with the logo.

All product specifications and information are subject to change without notice.