

CV-119/P2102 Series

19" TFT-LCD Modular Panel PC with 8th Gen. Intel® Core™ U Series Processor



HIGH PERFORMANCE INDUSTRIAL PANEL PC

| CV-100/P2000 Series |

Overview

 CONTACT

The CV-100/P2102 Series is a 12.1" - 24" TFT-LCD panel PC with Intel® 8th generation Core™ U Series Processor and is suitable for the high-performance requirement in factory and machine automation applications. The processor brings outstanding computing performance boost up to 84% at a TDP of 15 watts, compared to 6th generation Intel® Core™ U series. To enable faster responsiveness and deal with multi tasks with ease, the panel PC is equipped with two DDR4 2400 SODIMM sockets for up to 64 GB memory. With its slim design, the CV-100/P2102 Series offers extensive I/O to fulfill different connectivities and can easily fit into almost any space limited environment. For wireless connectivity, the CV-100/P2102 Series has 1x M.2 2230 E key and 2x full-size Mini-PCIe expansions which can be installed various add-on cards to enable Wi-Fi, 3G, and LTE communication. Besides, the CV-100/P2102 Series supports Control Function Module (CFM) Technology to install optional CFM modules for increasing power over ethernet and power ignition sensing functions according to user's specific applications. Featuring rigorous industrial protections, wide range operating temperature, IP65 dust/waterproof front panel, and wide range DC power input (9 to 48VDC), the CV-100/P2102 Series is appropriate for harsh environments and critical industrial applications. Furthermore, the CV-100/P2102 Series supports Cincoze patented Convertible Display System (CDS) technology, allowing users to replace display module or computer module on-site easily and thereby reducing maintenance costs and downtime.

Key Features

- 19" 1280 x 1024 (SXGA) TFT-LCD with Resistive 5-wire Touch / Projected Capacitive Touch
- Onboard 8th Generation Intel® Core™ U Series Processor
- 2x DDR4 SO-DIMM Socket, Supports Up to 2400MHz, 64GB
- Supports Triple Independent Display
- Integrated USB 3.2 Gen 2 supports up to 10Gbps
- M.2 E Key Socket for Wireless Module or Intel CRF Module
- Supports Ignition Sensing Function (IGN) (with optional CFM module)
- Supports 2x PoE+ Function (with optional CFM module)
- Designed with Rugged Aluminum Die-casting Front Bezel
- True Flat IP65 Compliant Front Panel Protection
- Supports Panel / VESA / Rack Mounting

Certifications



High Performance Per Watt

Powered by 8th generation Intel® Core™ U series processor (up to 4 cores, 4.10 GHz) at a TDP of only 15W, the CV-100/P2102 can fulfill a variety of applications that require high-performance computing and low power budget simultaneously.

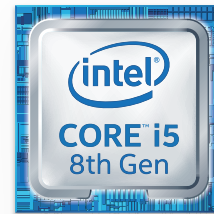

4X Cores

**Thickness
60.5 mm**



Slim Design with Multiple Functions

The CV-100/P2102 is designed at only 60.5 mm height and provides a wall-mount kit for easy installation in any space limited environment. Furthermore, a variety of I/O, 2x 2.5" SATA 3.0 drive bays, and M.2/mPCIe expansions are also available to fulfill multiple applications.

Patented CDS Technology

Thanks to Cincoze patented Convertible Display System (CDS) technology, the CV-100/P2102 not only makes maintenance easier but also provides upgradability whenever requested.



CV-119 Series Specifications

Model Name	CV-119R	CV-119C	CV-119G
Display			
LCD Size	• 19" (5:4)		
Max. Resolution	• 1280 x 1024		
Brightness (cd/m ²)	• 350		
Contrast Ratio	• 1000 : 1		
LCD Color	• 16.7M		
Pixel Pitch (mm)	• 0.294 (H) x 0.294 (V)		
Viewing Angle (H-V)	• 170 / 160		
Backlight LED Life Time	• 50,000 hrs (LED Backlight)		
Touch Screen			
Touch Type	• Resistive 5-wire	• Projected Capacitive	• Glass Screen
Physical			
Dimension (W x D x H)	• 510 x 389.3 x 63.2 mm		
Weight Information	• 6.96 kg		
Mechanical Construction	• Die-Casting Flat Surface		
Power			
Power Consumption	• 21.05W (Max.)	• 21W (Max.)	• 20.55W (Max.)
Environment			
Front Panel Protection	• IP 65 Compliant		
Operating Temperature	• 0°C to 50°C (with Industrial Grade peripherals; Ambient with air flow)		
Storage Temperature	• -20°C to 60°C		
Relative Humidity	• 80% RH @ 50°C (Non-condensing)		
EMC	• CE, UKCA, FCC, ICES-003 Class A		
EMI	<ul style="list-style-type: none"> • CISPR 32 Conducted & Radiated: Class A • EN/BS EN 55032 Conducted & Radiated: Class A • EN/BS EN IEC 61000-3-2 Harmonic current emissions: Class A • EN/BS EN61000-3-3 Voltage fluctuations & flicker • FCC 47 CFR Part 15B, ICES-003 Conducted & Radiated: Class A 		
EMS	<ul style="list-style-type: none"> • EN/IEC 61000-4-2 ESD: Contact: 4 kV; Air: 8 kV • EN/IEC 61000-4-3 RS: 80 MHz to 1000 MHz: 3 V/m • EN/IEC 61000-4-4 EFT: AC Power: 1 kV; DC Power: 0.5 kV; Signal: 0.5 kV • EN/IEC 61000-4-5 Surges: AC Power: 2 kV; Signal: 1 kV • EN/IEC 61000-4-6 CS: 3V • EN/IEC 61000-4-8 PFMF: 50 Hz, 1A/m • EN/IEC 61000-4-11 Voltage Dips & Voltage Interruptions: 0.5 cycles at 50 Hz 		
Safety	• UL, cUL, CB, IEC, EN 62368-1		

P2102 Series Specifications

Model Name	P2102	P2102E
System		
Processor	<ul style="list-style-type: none"> Onboard 8th Intel® Core™ U Processors (Whiskey Lake) <ul style="list-style-type: none"> Intel® Core™ i5-8365UE Quad Core Processor (6M Cache, up to 4.10 GHz) Intel® Core™ i3-8145UE Dual Core Processor (4M Cache, up to 3.90 GHz) TDP: 15 W 	
Memory	<ul style="list-style-type: none"> 2x DDR4 2400 MHz 260-Pin SO-DIMM Socket Support Un-buffered and Non-ECC Type up to 64 GB 	
Graphics		
Graphics Engine	<ul style="list-style-type: none"> Integrated Intel® UHD Graphics 620 	
Maximum Display Output	<ul style="list-style-type: none"> Supports Triple Independent Display 	
CDS	<ul style="list-style-type: none"> 1x CDS Connector for Cincoze Display Module 	
VGA	<ul style="list-style-type: none"> 1x VGA Connector(1920 x 1200 @60Hz) 	
DP	<ul style="list-style-type: none"> 1x DisplayPort Connector (4096 x 2304 @ 60Hz, According to CPU Specifications) * Verified maximum resolution: 3840 x2160 @ 60Hz 	
Audio		
Audio Codec	<ul style="list-style-type: none"> Realtek® ALC888, High Definition Audio 	
Line-out	<ul style="list-style-type: none"> 1x Line-out, Phone Jack 3.5mm 	
Mic-in	<ul style="list-style-type: none"> 1x Mic-in, Phone Jack 3.5mm 	
I/O		
LAN	<ul style="list-style-type: none"> 2x GbE LAN (Supports WoL, Teaming, Jumbo Frame & PXE), RJ45 <ul style="list-style-type: none"> GbE1: Intel® I219LM GbE2: Intel® I210 	
USB	<ul style="list-style-type: none"> 3x USB 3.2 Gen2 (Type A), 2x USB 2.0 (Type A) 	
Serial Port	<ul style="list-style-type: none"> 4x RS-232/422/485 with Auto Flow Control Support 5V/12V, DB9 	
DIO	<ul style="list-style-type: none"> 16x Isolated Digital I/O (8in/8out), 20-Pin Terminal Block 	
Storage		
SSD/HDD	<ul style="list-style-type: none"> 2x 2.5" HDD/SSD Drive Bay (SATA 3.0), Supports RAID 0/1 	
Expansion		
Mini PCI Express	<ul style="list-style-type: none"> 2x Full-size Mini-PCIe Sockets 	
PCI Express		<ul style="list-style-type: none"> 1x PCI or 1x PCIe x4 Expansion slot with Optional Riser Card * Supports maximum dimensions of add-on card (H x L) : 111 x 169mm
M.2 E Key Socket	<ul style="list-style-type: none"> 1x M.2 2230 E Key Socket for Wireless Module, Supports Intel CRF Module 	
SIM Socket	<ul style="list-style-type: none"> 1x Front Accessible SIM Socket 	
Universal Bracket		<ul style="list-style-type: none"> 2x Universal I/O Bracket
CFM (Control Function Module) Interface	<ul style="list-style-type: none"> 2x CFM Interface for optional IGN or PoE Module Expansion 	
CDS (Convertible Display System) Technology	<ul style="list-style-type: none"> 1x Convertible Display System (CDS) Interface 	

Other Function		
Clear CMOS Switch	• 1 x Clear CMOS Switch	
Instant Reboot	• Support 0.2sec Instant Reboot technology	
Watchdog Timer	• Software Programmable Supports 256 Levels System Reset	
Internal Speaker	• AMP 2W + 2W	
OSD Function	• LCD On/Off, Brightness Up, Brightness Down	
Reset Button	• 1x Reset Button	
Power		
Power Button	• 1x ATX Power On/Off Switch	
Power Mode Switch	• 1x AT/ATX Mode Switch	
Power Input	• 1x 3-pin Terminal Block Connector with Power Input 9~48VDC	
Power Adapter (Optional)	• 1x Optional AC/DC 12V/5A, 60W or 24V/5A 120W	
Remote Power On/Off	• 1x Remote Power On/Off Connector, 2-pin Terminal Block	
Physical		
Dimension(W x D x H)	• 254.5 x 190 x 41.5mm	• 254.5 x 190 x 61 mm
Weight Information	• 2.2 kg	• 2.7 kg
Mechanical Construction	• Extruded Aluminum with Heavy Duty Metal	
Mounting	• Wall / VESA / CDS / DIN Rail	
Physical Design	• Fanless Design • Jumper-less Design	
Reliability & Protection		
Reverse Power Input	• Yes	
Over Voltage Protection	• Protection Range: 51~58V • Protection Type: shut down operating voltage, re-power on at the present level to recover	
Over Current Protection	• 15A	
CMOS Battery Backup	• SuperCap Integrated for CMOS Battery Maintenance-free Operation	
MTBF	• 231,243 hours	
Operating System		
Microsoft® Windows®	• Windows®10	
Linux	• Supports by project	
Environment		
Operating Temperature	• Ambient with Air Flow: -40°C to 70°C (with Extended Temperature Peripherals)	
Storage Temperature	• -40°C to 70°C	
Relative humidity	• 95% RH @ 70°C (Non-condensing)	
Shock	• Operating, 50 Grms, Half-sine 11ms Duration (w/ SSD, according to IEC60068-2-27)	
Vibration	• Operating, 5 Grms, 5-500 Hz, 3 Axes (w/ SSD, according to IEC60068-2-64)	• Operating, 5 Grms, 5-500 Hz, 3 Axes (w/ SSD, according to IEC60068-2-64) • Operating, 1 Grms, 10-500 Hz, 3 Axes (w/ CV-W124 only, according to IEC60068-2-6)
EMC	• CE, UKCA, FCC, ICES-003 Class A	

EMI	<ul style="list-style-type: none"> • CISPR 32 Conducted & Radiated: Class A • EN/BS EN 55032 Conducted & Radiated: Class A • EN/BS EN IEC 61000-3-2 Harmonic current emissions: Class A • EN/BS EN61000-3-3 Voltage fluctuations & flicker • FCC 47 CFR Part 15B, ICES-003 Conducted & Radiated: Class A
EMS	<ul style="list-style-type: none"> • EN/IEC 61000-4-2 ESD: Contact: 4 kV; Air: 8 kV • EN/IEC 61000-4-3 RS: 80 MHz to 1000 MHz: 3 V/m • EN/IEC 61000-4-4 EFT: AC Power: 1 kV; DC Power: 0.5 kV; Signal: 0.5 kV • EN/IEC 61000-4-5 Surges: AC Power: 2 kV; Signal: 1 kV • EN/IEC 61000-4-6 CS: 3V • EN/IEC 61000-4-8 PFMF: 50 Hz, 1A/m • EN/IEC 61000-4-11 Voltage Dips & Voltage Interruptions: 0.5 cycles at 50 Hz
Safety	<ul style="list-style-type: none"> • UL, cUL, CB, IEC, EN62368-1
Fire Protection	<ul style="list-style-type: none"> • EN 45545-2

CV-119/P2102 External Layout

Front I/O

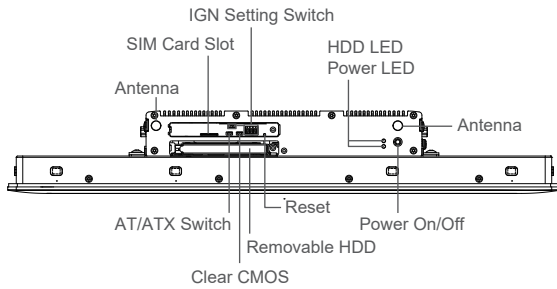

Rear I/O

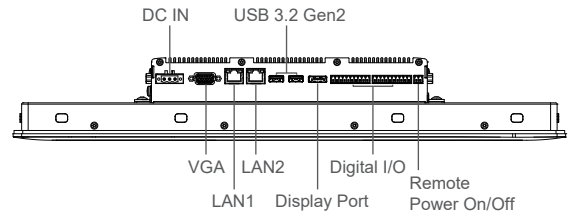

Left I/O

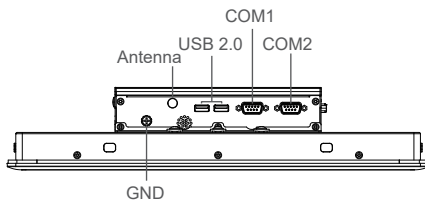

Right I/O

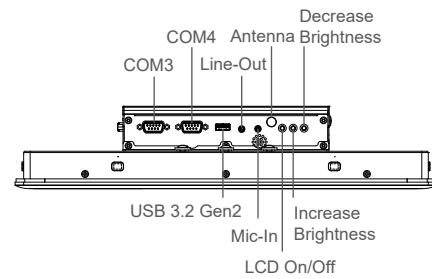

CV-119/P2102E External Layout

Front I/O

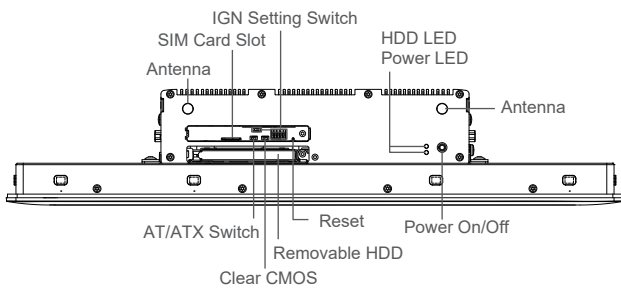

Rear I/O

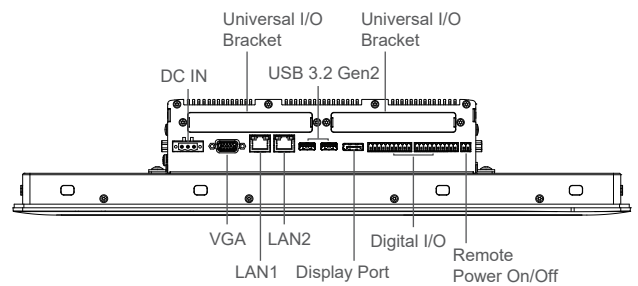

Left I/O

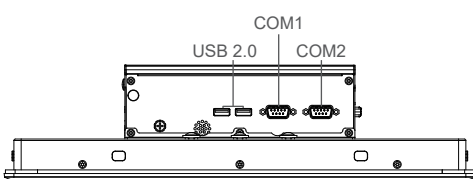

Right I/O

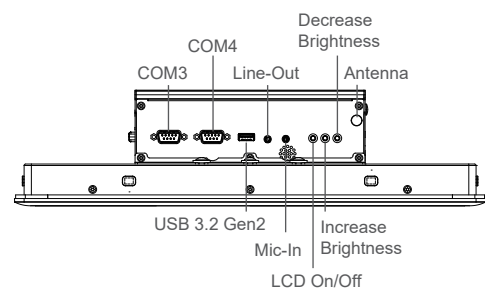

CV-119/P2102 Dimensions

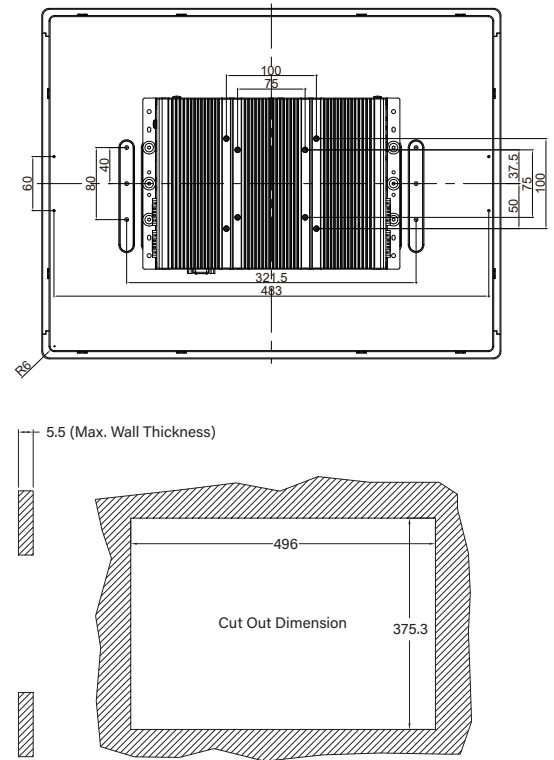
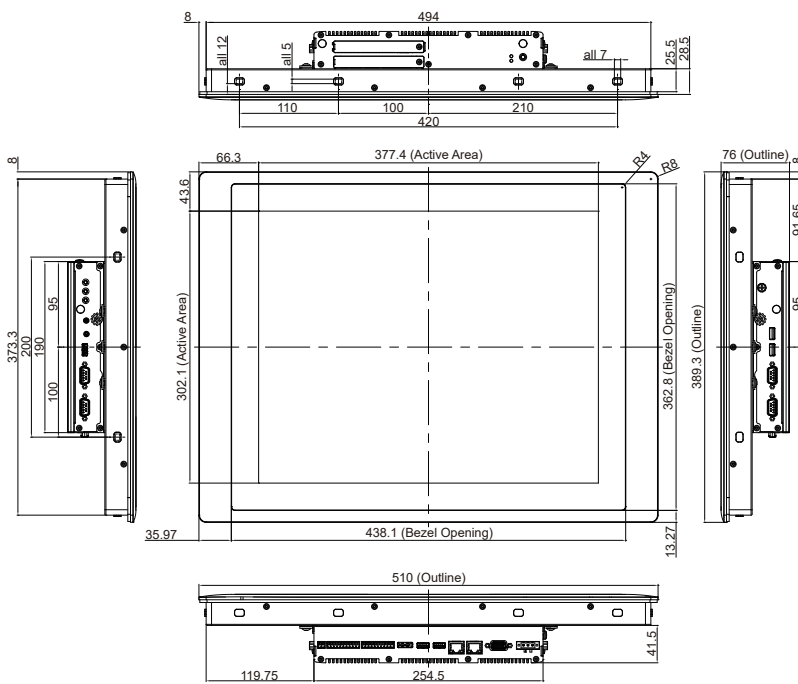

CV-119/P2102E Dimensions

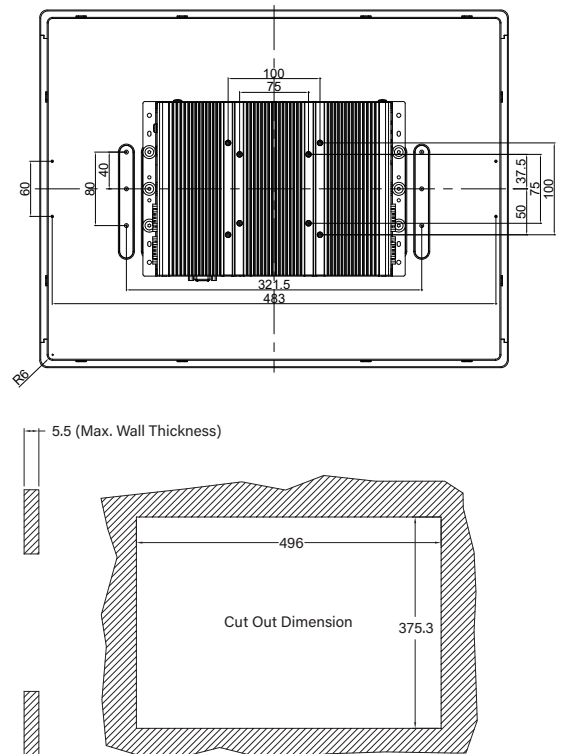
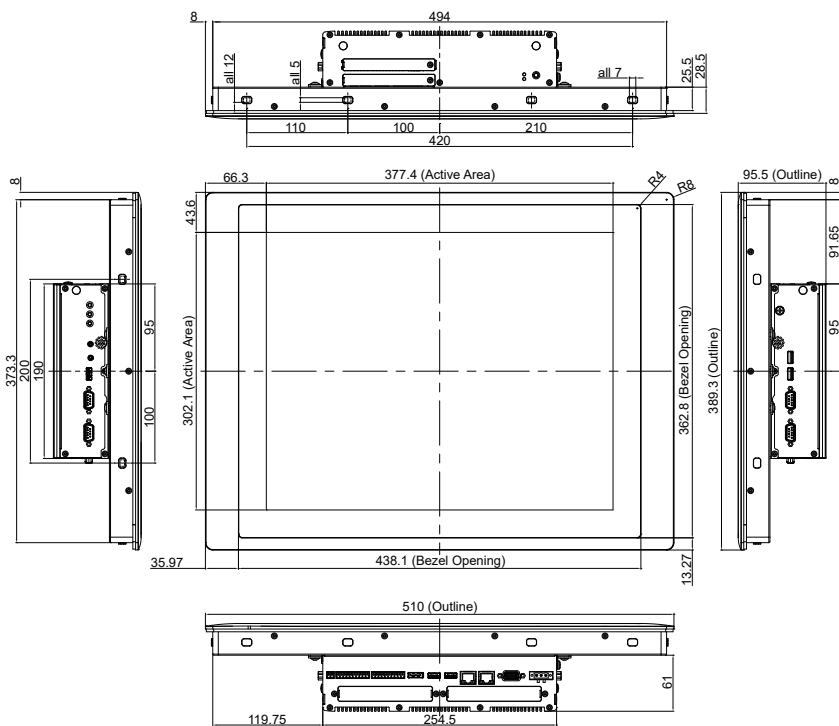

Unit: mm

Ordering Information

Available Models

Model No.	Description
CV-119R-R10/P2102-i5-R10	19" SXGA TFT-LCD Modular Panel PC with 8th Gen. Intel Core i5-8365UE Quad Core Processor and Resistive Touch
CV-119R-R10/P2102E-i5-R10	19" SXGA TFT-LCD Modular and Expandable Panel PC with 8th Gen. Intel Core i5-8365UE Quad Core Processor and Resistive Touch
CV-119C-R11/P2102-i5-R10	19" SXGA TFT-LCD Modular Panel PC with 8th Gen. Intel Core i5-8365UE Quad Core Processor and P-Cap. Touch
CV-119C-R11/P2102E-i5-R10	19" SXGA TFT-LCD Modular and Expandable Panel PC with 8th Gen. Intel Core i5-8365UE Quad Core Processor and P-Cap. Touch
CV-119G-R10/P2102-i5-R10	19" SXGA TFT-LCD Modular Panel PC with 8th Gen. Intel Core i5-8365UE Quad Core Processor and Glass Only
CV-119G-R10/P2102E-i5-R10	19" SXGA TFT-LCD Modular Panel PC with 8th Gen. Intel Core i5-8365UE Quad Core Processor and Glass Only
CV-119R-R10/P2102-i3-R10	19" SXGA TFT-LCD Modular Panel PC with 8th Gen. Intel Core i3-8145UE Dual Core Processor and Resistive Touch
CV-119R-R10/P2102E-i3-R10	19" SXGA TFT-LCD Modular and Expandable Panel PC with 8th Gen. Intel Core i3-8145UE Dual Core Processor and Resistive Touch
CV-119C-R11/P2102-i3-R10	19" SXGA TFT-LCD Modular Panel PC with 8th Gen. Intel Core i3-8145UE Dual Core Processor and P-Cap. Touch
CV-119C-R11/P2102E-i3-R10	19" SXGA TFT-LCD Modular and Expandable Panel PC with 8th Gen. Intel Core i3-8145UE Dual Core Processor and P-Cap. Touch
CV-119G-R10/P2102-i3-R10	19" SXGA TFT-LCD Modular Panel PC with 8th Gen. Intel Core i3-8145UE Dual Core Processor and Glass Only
CV-119G-R10/P2102E-i3-R10	19" SXGA TFT-LCD Modular and Expandable Panel PC with 8th Gen. Intel Core i3-8145UE Dual Core Processor and Glass Only

Model Configuration

	CV-119R	CV-119C	CV-119G	P2102(i3/i5)	P2102E(i3/i5)
CV-119R/P2102	V	--	--	V	--
CV-119C/P2102	--	V	--	V	--
CV-119G/P2102	--	--	V	V	--
CV-119R/P2102E	V	--	--	--	V
CV-119C/P2102E	--	V	--	--	V
CV-119G/P2102E	--	--	V	--	V

V : Compatible

Package Checklist





• CV-119/P2102 Series Panel PC x 1	• Power Terminal Block Connector (Female) x 1
• Panel Mounting Kit x 1	• Screw Pack x 5
• DIO Terminal Block Connector (Female) x 2	• Remote Power On/Off Terminal Block Connector x 1
• PCI / PCIe Card Installation Kit x 1(For P2102E only)	• Thermal Pad (for CPU Thermal Block) x 1

Optional Modules and Accessories

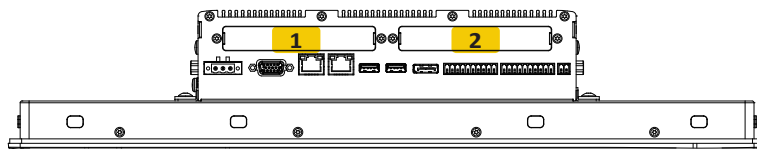
Model No.	Description
MEC-COM-M212-DB9	Mini-PCIe Module with 2x RS-232 Serial Ports, 1x Standard DB9 Cable (For P2102E Only)
MEC-COM-M334-TDB9	Mini-PCIe Module with 4x RS-232/422/485 Serial Ports, 2x Thin DB9 Cable (For P2102E Only)
MEC-LAN-M102-30	Mini-PCIe Module with 2x LAN Ports, 2x 30cm (For P2102E Only)
MEC-USB-M102-30	Mini-PCIe Module with 2x USB 3.2 Gen1 Ports (For P2102E Only)
CFM-IGN101	CFM Module with Power Ignition Sensing Control Function, 12V/24V Selectable
CFM-PoE04	PoE Control Function Module, Individual Port 25.5W (For P2102 only)
CFM-PoE05	PoE Control Function Module, Individual Port 25.5W (For P2102E only)
RC-E4-02	Riser Card with 1x PCIe4 Slot (For P2102E only)
RC-PI-02	Riser Card with 1x PCI Slot (For P2102E only)
UB1203	Universal Bracket with 2x DB9 Cutout (For P2102E only)
UB1211	Universal Bracket with 2x RJ45 Cutout (For P2102E only)
UB1214	Universal Bracket with 2x USB Cutout (For P2102E only)
URM01	Universal 19" Rack Mount Kit for Industrial Panel PC & Industrial Monitor
GST120A24-CIN	Adapter AC/DC 24V 5A 120W, GST120A24-CIN, wide temp(-30°C ~ +70°C), level VI
GST60A12-CIN1	Adapter AC/DC 12V 5A 60W, GST60A12-CIN1, wide temp(-30°C ~ +70°C)
SL2-SL3	US 2 heads power cord, US B type to IEC C13,SVT 18AWG/3C Black 1.8M
SL6-SL3	EU 2 heads power cord, EU G type to IEC C13,H05VV-F 0.75mm2/3G Black 1.8M
QP026-SL3	UK 2 heads power cord, UK I type to IEC C13,H05VV-F 0.75mm2/3G Black 1.8M

Optional Module Configuration (For P2102E only)



Model No.	Description	1	2
 <p>MEC-COM-M212-TDB9/UB1203</p>	Mini-PCIe Module with 2x COM Ports, 1x Standard DB9 Cable, 2x Universal Bracket each with 1x DB9 Cutout	V	V
 <p>MEC-COM-M334-TDB9/UB1203</p>	Mini-PCIe Module with 4x RS-232/422/485 Serial Ports	V	V
 <p>MEC-LAN-M102-30/UB1211</p>	Mini-PCIe Module with 2x LAN Ports, 2x 30cm cable, w/ 1x Universal Bracket with 2x RJ45 Cutout	V	V
 <p>MEC-USB-M102-30/UB1214</p>	Mini-PCIe Module with 2x USB 3.2 Gen1 Ports, 1x 30cm cable, 1x Universal Bracket with 2x USB Cutout	V	V

V : Compatible